

INSTRUCTION MANUAL

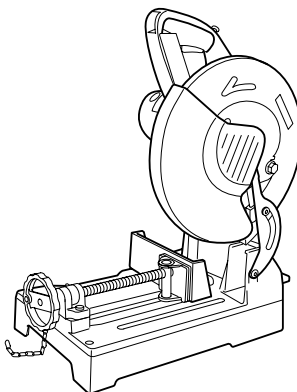

Metal Cutting Saw

LC1230



003770

 DOUBLE INSULATION

IMPORTANT: Read Before Using.

ENGLISH (Original instructions)

SPECIFICATIONS

Model	LC1230
Blade diameter	305 mm
Hole (arbor) diameter	25.4 mm
No load speed (min ⁻¹)	1,300
Dimensions (L x W x H)	516 mm x 306 mm x 603 mm
Net weight	19.3kg
Safety class	□/II

Cutting capacity

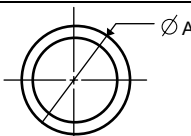
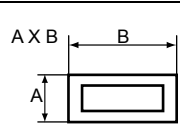
Workpiece shape			
Cutting angle	90°	115mm	75 mm x 150 mm 100 mm x 100 mm
	45°	90mm	85 mm x 85mm

- Due to our continuing programme of research and development, the specifications herein are subject to change without notice.
- Specifications may differ from country to country.
- Weight according to EPTA-Procedure 01/2003

END205-3

ENE008-1

Symbols

The following show the symbols used for the equipment. Be sure that you understand their meaning before use.



- Read instruction manual.



- DOUBLE INSULATION



- To avoid injury from flying debris, keep holding the saw head down, after making cuts, until the blade has come to a complete stop.



- For your safety, remove the chips, small pieces, etc. from the table top before operation.



- Only for EU countries
Do not dispose of electric equipment together with household waste material! In observance of European Directive 2002/96/EC on waste electric and electronic equipment and its implementation in accordance with national law, electric equipment that have reached the end of their life must be collected separately and returned to an environmentally compatible recycling facility.

Intended use

The tool is intended for cutting in mild steel and stainless steel with appropriate saw blades.

ENF002-2

Power supply

The tool should be connected only to a power supply of the same voltage as indicated on the nameplate, and can only be operated on single-phase AC supply. They are double-insulated and can, therefore, also be used from sockets without earth wire.

ENF100-1

For public low-voltage distribution systems of between 220 V and 250 V.

Switching operations of electric apparatus cause voltage fluctuations. The operation of this device under unfavorable mains conditions can have adverse effects to the operation of other equipment. With a mains impedance equal or less than 0.25 Ohms it can be presumed that there will be no negative effects. The mains socket used for this device must be protected with a fuse or protective circuit breaker having slow tripping characteristics.

ENG905-1

Noise

The typical A-weighted noise level determined according to EN61029:

- Sound pressure level (L_{pA}) : 98 dB(A)
- Sound power level (L_{WA}) : 108 dB(A)
- Uncertainty (K) : 3 dB(A)

Wear ear protection

ENG900-1

Vibration

The vibration total value (tri-axial vector sum) determined according to EN61029:

Vibration emission (a_h) : 4.5 m/s²

Uncertainty (K) : 1.5 m/s²

ENG901-1

- The declared vibration emission value has been measured in accordance with the standard test method and may be used for comparing one tool with another.
- The declared vibration emission value may also be used in a preliminary assessment of exposure.

WARNING:

- The vibration emission during actual use of the power tool can differ from the declared emission value depending on the ways in which the tool is used.
- Be sure to identify safety measures to protect the operator that are based on an estimation of exposure in the actual conditions of use (taking account of all parts of the operating cycle such as the times when the tool is switched off and when it is running idle in addition to the trigger time).

ENH003-13

For European countries only

EC Declaration of Conformity

We Makita Corporation as the responsible manufacturer declare that the following Makita machine(s):

Designation of Machine:

Metal Cutting Saw

Model No./ Type: LC1230

are of series production and

Conforms to the following European Directives:

2006/42/EC

And are manufactured in accordance with the following standards or standardised documents:

EN61029

The technical documentation is kept by our authorised representative in Europe who is:

Makita International Europe Ltd.

Michigan Drive, Tongwell,

Milton Keynes, Bucks MK15 8JD, England

30.1.2009



Tomoyasu Kato

Director

Makita Corporation

3-11-8, Sumiyoshi-cho,

Anjo, Aichi, 446-8502, JAPAN

000230

ENA001-2

SAFETY INSTRUCTIONS

WARNING! When using electric tools, basic safety precautions, including the following, should always be followed to reduce the risk of fire, electric shock and personal injury. Read all these instructions before operating this product and save these instructions.

For safe operations:

1. **Keep work area clean.**
Cluttered areas and benches invite injuries.
2. **Consider work area environment.**
Do not expose power tools to rain. Do not use power tools in damp or wet locations. Keep work area well lit. Do not use power tools where there is risk to cause fire or explosion.
3. **Guard against electric shock.**
Avoid body contact with earthed or grounded surfaces (e.g. pipes, radiators, ranges, refrigerators).
4. **Keep children away.**
Do not let visitors touch the tool or extension cord. All visitors should be kept away from work area.
5. **Store idle tools.**
When not in use, tools should be stored in a dry, high or locked up place, out of reach of children.
6. **Do not force the tool.**
It will do the job better and safer at the rate for which it was intended.
7. **Use the right tool.**
Do not force small tools or attachments to do the job of a heavy duty tool. Do not use tools for purposes not intended; for example, do not use circular saws to cut tree limbs or logs.
8. **Dress properly.**
Do not wear loose clothing or jewellery, they can be caught in moving parts. Rubber gloves and non-skid footwear are recommended when working outdoors. Wear protecting hair covering to contain long hair.
9. **Use safety glasses and hearing protection.**
Also use face or dust mask if the cutting operation is dusty.

10. **Connect dust extraction equipment.**
If devices are provided for the connection of dust extraction and collection facilities ensure these are connected and properly used.
11. **Do not abuse the cord.**
Never carry the tool by the cord or yank it to disconnect it from the socket. Keep the cord away from heat, oil and sharp edges.
12. **Secure work.**
Use clamps or a vice to hold the work. It is safer than using your hand and it frees both hands to operate the tool.
13. **Do not overreach.**
Keep proper footing and balance at all times.
14. **Maintain tools with care.**
Keep cutting tools sharp and clean for better and safer performance. Follow instructions for lubrication and changing accessories. Inspect tool cord periodically and if damaged have it repaired by an authorized service facility. Inspect extension cords periodically and replace, if damaged. Keep handles dry, clean and free from oil and grease.
15. **Disconnect tools.**
When not in use, before servicing and when changing accessories such as blades, bits and cutters.
16. **Remove adjusting keys and wrenches.**
Form the habit of checking to see that keys and adjusting wrenches are removed from the tool before turning it on.
17. **Avoid unintentional starting.**
Do not carry a plugged-in tool with a finger on the switch. Ensure switch is off when plugging in.
18. **Use outdoor extension leads.**
When tool is used outdoors, use only extension cords intended for outdoor use.
19. **Stay alert.**
Watch what you are doing. Use common sense. Do not operate tool when you are tired.
20. **Check damaged parts.**
Before further use of the tool, a guard or other part that is damaged should be carefully checked to determine that it will operate properly and perform its intended function. Check for alignment of moving parts, free running of moving parts, breakage of parts, mounting and any other conditions that may affect its operation. A guard or other part that is damaged should be properly repaired or replaced by an authorized service center unless otherwise indicated in this instruction manual. Have defective switches replaced by an authorized service facility. Do not use the tool if the switch does not turn it on and off.

21. **Warning.**
The use of any accessory or attachment, other than those recommended in this instruction manual or the catalog, may present a risk of personal injury.
22. **Personal tool repaired by a qualified person.**
This electric tool is in accordance with the relevant safety requirements. Repairs should only be carried out by qualified persons using original spare parts, otherwise this may result in considerable danger to the user.

ENB076-1

ADDITIONAL SAFETY RULES FOR TOOL

1. **Always use safety glasses, dust mask and ear protector.**
2. **Use only Makita genuine carbide-tipped saw blade 305 mm in diameter for metal cutting. Never use abrasive cut-off wheel or other type of saw blades.**
3. **Check the blade carefully for cracks or damage before operation. Replace cracked or damaged blade immediately.**
4. **Never secure the safety cover (safety guard). Always be sure that the safety cover moves smoothly before operation. Any irregular operation of the safety cover should be corrected immediately. Do not use the saw without guards in position.**
5. **Be sure shaft lock is released before the switch is turned on.**
6. **Before using the tool on an actual workpiece, let it run for a while. Watch for vibration or wobbling that could indicate poor installation or a poorly balanced blade.**
7. **Keep your hands and body away from rotating blade.**
8. **Always secure the workpiece with the vise.**
9. **Make sure the blade is not contacting the workpiece before the switch is turned on.**
10. **Watch out for flying sparks when operating. They can cause injury or ignite combustible materials.**
11. **Do not touch the blade, workpiece or cutting chips immediately after operation; they may be extremely hot and could burn your skin.**
12. **If the blade stops during operation, makes an odd noise or begins to vibrate, switch off the tool immediately. Then check the tool and blade.**

SAVE THESE INSTRUCTIONS.

INSTALLATION

Positioning the tool

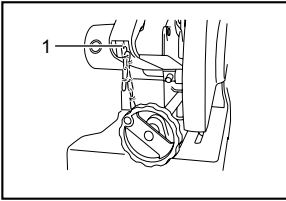

1. Hook

003771

When the tool is shipped from the factory, the handle is locked in the lowered position. Release the handle from the lowered position by lowering it slightly and removing the chain from the hook on the handle.

Bolt the tool with two bolts to a level and stable surface using the bolt holes provided in the tool base. This will help prevent tipping and possible injury.

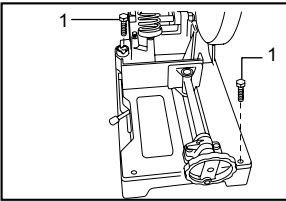

1. Bolt

003772

FUNCTIONAL DESCRIPTION

⚠ CAUTION:

- Always be sure that the tool is switched off and unplugged before adjusting or checking function on the tool.

Switch action

⚠ CAUTION:

- Before plugging in the tool, always check to see that the switch trigger actuates properly and returns to the "OFF" position when released.
- When not using the tool, remove the lock-off button and store it in a secure place. This prevents unauthorized operation.

For European countries

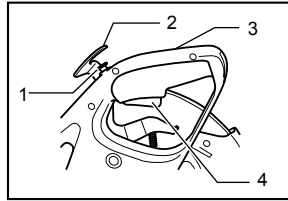

1. Lock-off button
2. Lever
3. Handle
4. Switch trigger

004708

To prevent the switch trigger from being accidentally pulled, a lock-off button is provided. To start the tool, depress the lever to release the handle from the fully elevated position and to press in the lock-off button, and then pull the switch trigger. Release the switch trigger to stop.

For all countries other than European countries

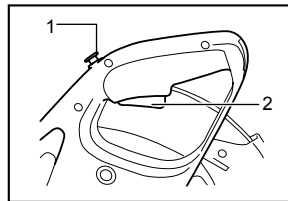

1. Lock-off button
2. Switch trigger

003773

To prevent the switch trigger from being accidentally pulled, a lock-off button is provided.

To start the tool, depress the lock-off button and pull the switch trigger. Release the switch trigger to stop.

Setting for desired cutting angle

⚠ CAUTION:

- Always tighten the hex bolt securely after changing the cutting angle.

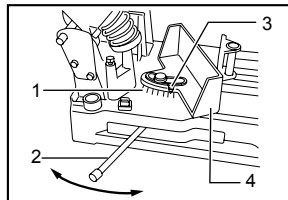

1. Graduation
2. Lever
3. indicator
4. Vise stop

003774

To change the cutting angle, loosen the lever. Move the vise stop so that the indicator will point to the desired graduation. Then tighten the lever to secure the vise stop.

Dust collection

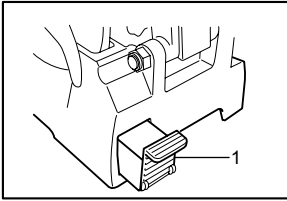

1. Dust box

003775

⚠CAUTION:

- Do not touch any part of the dust box except its handle immediately after operation; it may be extremely hot and could burn your skin.

This tool is equipped with the dust box to collect dust and cut chips. When the dust box is full, hold the handle of the dust box and raise it slightly. Then pull the dust box out of the tool base. Empty the dust box of its contents.

ASSEMBLY

⚠CAUTION:

- Always be sure that the tool is switched off and unplugged before carrying out any work on the tool.

Socket wrench storage

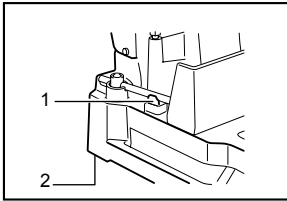

1. Wrench holder
2. Base

003776

The socket wrench is stored as shown in the figure. When using the socket wrench, pull it out of the wrench holder. After using the socket wrench, return it to the wrench holder.

Installing or removing saw blade

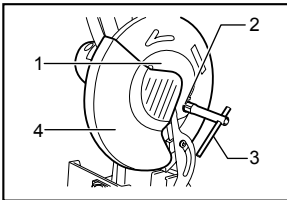

1. Center cover
2. Hex bolt
3. Socket wrench
4. Blade guard

003777

⚠CAUTION:

- When mounting the blade, make sure that the direction of the arrow on the surface of the blade matches the direction of the arrow on the blade case.
- Use only the Makita socket wrench provided to install or remove the blade. Failure to do so may result in overtightening or insufficient tightening of the hex bolt. This could cause a personal injury.
- Do not touch the blade immediately after operation; it may be extremely hot and could burn your skin.

To remove the blade, use the socket wrench to loosen the hex bolt holding the center cover by turning it counterclockwise. Raise the blade guard and center cover.

Press the shaft lock to lock the spindle and use the socket wrench to loosen the hex bolt by turning counterclockwise. Then remove the hex bolt, outer flange and blade.

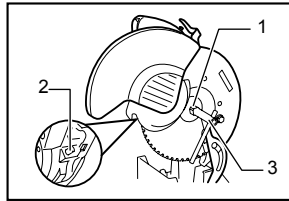

1. Hex bolt
2. Shaft lock
3. Socket wrench

003778

To install the blade, mount the inner flange, saw blade, outer flange and hex bolt onto the spindle in that order. Tighten the hex bolt by turning clockwise while pressing the shaft lock. Return the blade guard and center cover to the original position. Then tighten the hex bolt clockwise to secure the center cover. Lower the handle to make sure that the blade guard moves properly.

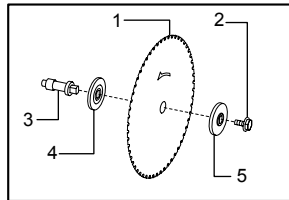

1. Carbide-tipped saw blade
2. Hex bolt
3. Spindle
4. Inner flange
5. Outer flange

003801

Securing workpiece

⚠CAUTION:

- Always set the vise nut to the right fully when securing the workpiece. Failure to do so may result in insufficient securing of the workpiece. This could cause the workpiece to be ejected or cause damage to the blade.

By turning the vise handle counterclockwise and then flipping the vise nut to the left, the vise is released from the shaft threads and can be moved rapidly in and out. To grip workpieces, push the vise handle until the vise plate contacts the workpiece. Flip the vise nut to the right and then turn the vise handle clockwise to securely retain the workpiece.

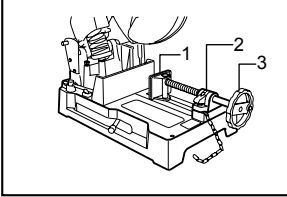

1. Vise plate
2. Vise nut
3. Vise handle

003780

Long workpieces must be supported by blocks of non-flammable material on either side so that it will be level with the base top.

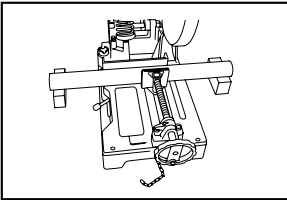

003781

OPERATION

Cutting operation

⚠CAUTION:

- Never attempt to cut workpieces less than 2 mm thick except pipe or workpieces which cannot be secured firmly with the vise. The piece cut off may be caught by the blade, causing dangerous scattering of chips and/or damage to the carbide-tips. Possible serious injury may result.
- Do not apply excessive pressure on the handle when cutting. Too much pressure may result in overload of the motor, decreased cutting efficiency and/or damage to the carbide-tips or blade itself.
- Too little pressure on the handle may result in more sparks and premature blade wear.
- Do not touch the blade, workpiece or cutting chips immediately after operation; they may be extremely hot and could burn your skin.
- If the blade stops during operation, makes an odd noise or begins to vibrate, switch off the tool immediately. Replace cracked or damaged blade with a new one.
- Do not cut aluminum, wood, plastics, concrete, tiles, etc.
- Always use carbide-tipped saw blades appropriate for your job. The use of inappropriate saw blades may cause a poor cutting performance and/or present a risk of personal injury.

Recommended Carbide-tipped saw blade & workpiece ranges

Diameter & number of teeth	Application	Applicable workpiece & thickness range				
		Angles	Pipes	Channels	Stainless Pipes	Stainless Angles
305 * 60	Mild Steel	4 mm or more	3 - 5 mm	4 mm or more	NA	NA
305 * 60	Mild Steel (Lessened Noise Type)	4 mm or more	3 - 5 mm	4 mm or more	NA	NA
305 * 78	Thin Mild Steel	3 - 6 mm	1.2 - 5 mm	2 mm or more	NA	NA
305 * 78	Stainless Steel	3 - 6 mm	1.2 - 5 mm	4 mm or more	1.2 - 5 mm	3 - 4 mm

* Standard blade may differ from country to country.

(NA ...Not applicable)

* Carbide-tipped saw blades for metal cutting saw are not to be re-sharpened.

006435

Hold the handle firmly. Switch on the tool and wait until the blade attains full speed. Then lower the handle gently to bring the blade close to the workpiece. When the blade makes contact, ease into the cut gently at first, then gradually add pressure as the cutting position steadies. Your pressure on the handle should be adjusted to produce the minimum amount of sparks.

When the cut is completed, switch off the tool and WAIT UNTIL THE BLADE HAS COME TO A COMPLETE STOP before returning the handle to the fully elevated position. If the handle is raised while the blade is still rotating, the piece cut off may be caught by the blade, causing dangerous scattering of chips. When cutting only part of the way into a workpiece, raise the handle while the blade is rotating. Switching off during the cut may cause damage to the carbide-tips as they contact the workpiece.

Cutting angles

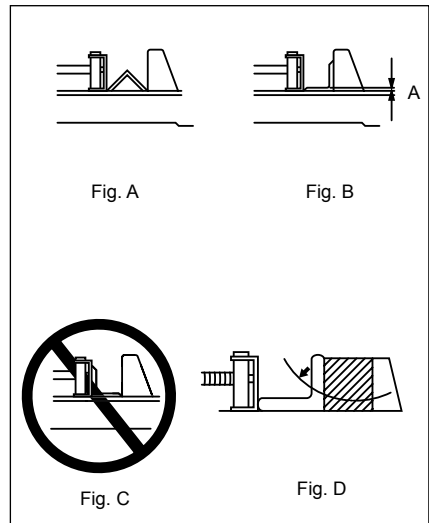

003782

Secure the workpiece in the vise as shown in the Figure A and proceed to cut it. The saw blade life will be shortened if the workpiece is cut as shown in the Fig B.

⚠CAUTION:

- Do NOT cut the workpiece as shown in the Fig. C since this may cause it to be ejected from the vise, possibly resulting in injury.

The saw blade is subjected to greater wear when the area A in the Fig. B is cut. Place a wooden block up against the workpiece as shown in the Fig. D so that the saw blade will enter area A at an angle. This will help to extend the saw blade life.

The allowable cutting dimensions are reduced when a wooden block is used. Use a wooden block whose dimensions are equivalent to the maximum allowable cutting dimensions minus the dimensions of the workpiece to be cut. This will further minimize the shortening of the saw blade life.

Cutting pipes, squares and channels

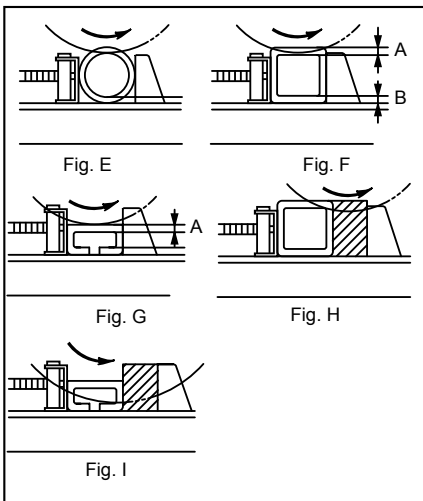

003783

The saw blade is subjected to greater wear when the areas A and B in figure F and figure G are cut. Place a wooden block up against the workpiece as shown in figure H and figure I so that the saw blade will enter areas A and B at an angle. This will help to minimize the shortening of the saw blade life.

The allowable cutting dimensions are reduced when a wooden block is used. Use a wooden block whose dimensions are equivalent to the maximum allowable cutting dimensions minus the dimensions of the workpiece to be cut. This will further minimize the shortening of the saw blade life.

Cutting rectangles

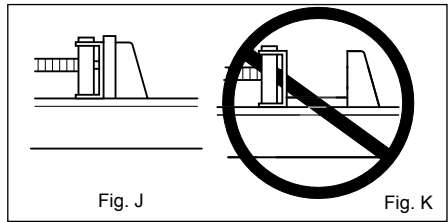

003784

Secure the workpiece in the vise as shown in figure J, and proceed to cut it.

⚠CAUTION:

- Do NOT cut the workpiece as shown in figure K since this may cause it to be ejected from the vise, possibly resulting in injury.

Carrying tool

⚠CAUTION:

- The chain for transportation shall be adjusted to minimize the accessible zone of the saw blade before transporting the tool.

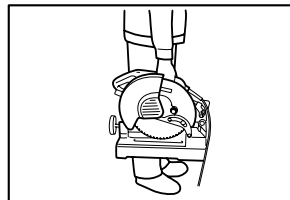

003785

Fold down the tool head to the position where you can attach the chain to the hook on the handle. Grasp the carrying grip when carrying the tool.

MAINTENANCE

⚠CAUTION:

- Always be sure that the tool is switched off and unplugged before attempting to perform inspection or maintenance.
- Never use gasoline, benzine, thinner, alcohol or the like. Discoloration, deformation or cracks may result.

Replacing saw blade

Continuing to use a dull and worn blade may cause motor overload and decreased cutting efficiency. Replace with a new blade as soon as it is no longer effective.

Replacing carbon brushes

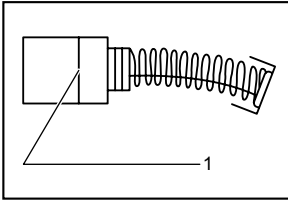

1. Limit mark

001145

Remove and check the carbon brushes regularly. Replace when they wear down to the limit mark. Keep the carbon brushes clean and free to slip in the holders. Both carbon brushes should be replaced at the same time. Use only identical carbon brushes.

Use a screwdriver to remove the brush holder caps. Take out the worn carbon brushes, insert the new ones and secure the brush holder caps.

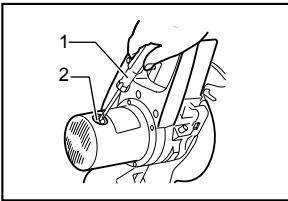

1. Screwdriver
2. Brush holder cap

003786

To maintain product SAFETY and RELIABILITY, repairs, any other maintenance or adjustment should be performed by Makita Authorized Service Centers, always using Makita replacement parts.

OPTIONAL ACCESSORIES

⚠CAUTION:

- These accessories or attachments are recommended for use with your Makita tool specified in this manual. The use of any other accessories or attachments might present a risk of injury to persons. Only use accessory or attachment for its stated purpose.

If you need any assistance for more details regarding these accessories, ask your local Makita Service Center.

- Carbide-tipped saw blade
- Safety goggle
- Socket wrench 17
- Lock-off button (Switch button)

NOTE:

- Some items in the list may be included in the tool package as standard accessories. They may differ from country to country.

Makita Corporation
Anjo, Aichi, Japan

884227E224

www.makita.com