

AQUALISA

QUARTZ™ INSTALLATION GUIDE



IMPORTANT INFORMATION

Safety information

This appliance can be used by children aged from 3 years and above and persons with reduced physical, sensory or mental capabilities or lack of experience and knowledge if they have been given supervision or instruction concerning use of the appliance in a safe way and understand the hazards involved.

Children shall not play with the appliance.

Cleaning and user maintenance shall not be made by children without supervision.

This product must be installed by a competent person in accordance with all relevant current local and national Water Supply Regulations.

ALL PRODUCTS REQUIRING AN ELECTRICAL CONNECTION MUST BE INSTALLED BY A QUALIFIED PERSON FOLLOWING THE LATEST REVISION OF THE ELECTRICAL WIRING REGULATIONS, BOTH NATIONAL AND LOCAL AND CERTIFIED TO CURRENT BUILDING REGULATIONS.

This system should be installed so that other taps or appliances operated elsewhere within the premises do not significantly affect the flow.

The Quartz Smart Valve™ must not be used with a hot water supply temperature of over 65°C. If the maximum hot water temperature is likely to rise above 65°C then a Thermostatic Blending Valve must be used.

The Quartz Smart Valve™ is supplied factory pre-set at maximum temperature of 45°C. The maximum temperature is fully adjustable to suit site conditions. If adjusted, we recommend the outlet temperature is set to a **MAXIMUM** of 46°C.

The Quartz Smart Valve™ must be installed in an accessible location for servicing and maintenance.

The Quartz Smart Valve™ must not be installed in situations where either the ambient temperature is likely to exceed 40°C or where freezing may occur.

The controller must not be installed in situations where the ambient temperature is likely to fall below 5°C or rise above 40°C.

We do not recommend the use of a controller in steam therapy facilities.

This appliance must be earthed.

Cables must be protected by a suitably sized conduit or trunking to avoid risk of damage and to allow removal for service and maintenance purposes. Failure to install this way may invalidate the warranty.

Ensure that the conduit is run to avoid the controller fixing holes.

Surface mounted cables must also be protected by a suitable approved conduit, even in a loft, where there may be a risk of damage from vermin.

The power lead must only be replaced by the manufacturer or his accredited agent.

The controller is supplied from a safety low voltage source.

This product is suitable for domestic use only.

Aqualisa products are supplied complete with a 1 year guarantee that can be upgraded by registering the product with Aqualisa.

See www.aqualisa.co.uk/guarantee for details.

Installation of the pumped Quartz Smart Valve™ (for gravity stored systems)

The pumped Quartz Smart Valve™ shower system is designed to operate up to a maximum static pressure of 100kPa ((1 bar)(10 metres head)(14.5psi)). Under no circumstances must the pumped Quartz Smart Valve™ be connected directly to the water main or in line with another booster pump.

The minimum actual capacity of the cold water storage cistern should be not less than 225 litres (50 gallons). The capacity of the hot water cylinder must be capable of meeting anticipated demand.

Installation of the standard (unpumped) Quartz Smart Valve™ (for balanced high pressure and unvented systems, combination boiler systems and separately pumped gravity systems)

Pressures: The standard (unpumped) Quartz Smart Valve™ is designed to operate up to a maximum static pressure of 700kPa ((7 bar)(100psi)). Where pressures are likely to exceed 700kPa ((7 bar)(100psi)), a pressure reducing valve must be fitted to the incoming mains supply. A setting of 400kPa ((4 bar)(60psi)) is recommended. It should be noted that daytime pressures approaching 600kPa ((6 bar)(80psi)) can rise above the stated maximum overnight.

Special notes for combination boiler systems

The appliance must have a minimum domestic hot water rating of 24kW and be of the type fitted with a fully modulating gas valve.

If in any doubt, please contact the appliance manufacturer before installation commences.

PLEASE NOTE: DUE TO PERFORMANCE CHARACTERISTICS OF COMBINATION BOILERS, SEASONAL INLET TEMPERATURE CHANGE WILL AFFECT THE QUARTZ SMART VALVE™ OUTLET FLOW RATE RESULTING IN VARYING SHOWER FLOW RATE AND FLOW CONTROL RANGE. INLET TEMPERATURE CHANGE MAY ALSO CAUSE THE TEMPERATURE DISPLAY TO FLASH; THIS IS NOT NECESSARILY CHANGING THE OUTLET TEMPERATURE.

Special notes for separately pumped gravity systems and universal/negative head pumps (for divert systems)

We recommend a **MINIMUM** pump rating of 1.5 bar. For optimum performance a 2.5 bar pump should be used for all separately pumped installations.

A twin ended pump is required for use with single outlet products.

A universal/negative head type twin ended pump (works on both positive and negative head conditions) **MUST** be used with divert products.

The minimum actual capacity of the cold water storage cistern should be not less than 225 litres (80 gallons). The capacity of the hot water cylinder must be capable of meeting the anticipated demand.

THIS PRODUCT IS NOT SUITABLE FOR USE WITH A SINGLE ENDED PUMP.

Shower Heads

The range of shower heads has been designed for use with Quartz™ systems.

Installation of any shower heads other than these may result in poor shower performance.

If at any stage during installation you have any questions then please contact the Aqualisa Customer Service Department on 01959 560010 for advice.

Connections

This product incorporates 15mm 'push-fit' type connections. Tube should be cut using a rotary type cutter and lubricated using a silicone grease, petroleum jelly, or similar, prior to insertion into the fitting. 15mm pipework must be used to connect the product.

If plastic pipe is used, the tube insert must not increase the tube diameter or extend the cut-off length by more than 2mm.

THESE FITTINGS ARE NOT SUITABLE FOR STAINLESS STEEL TUBE. COMPRESSION FITTINGS MUST NOT BE USED.

Pipe sizing

PLEASE NOTE: Check pipe size requirements for connections to outlets and accessories.

Long pipe runs, on both inlet and outlet, will reduce the flow rate at the shower head, 22mm pipe work should be used on inlets and reduce down to 15mm as close to the valve as possible to reduce pressure losses and help maintain flow rate. If using 15mm pipe, copper pipe is preferred, to optimise performance minimise the number of elbows used. If long pipe runs are unavoidable on the outlet, use copper pipe rather than plastic, particularly if a diverter is used, and minimise the number of elbows as the pipe inserts are very restrictive.



Flushing

Some modern fluxes can be very corrosive and, if left in contact, will attack the working parts of this unit. All soldering must be completed and the pipe work thoroughly flushed out in accordance with current local and national Water Supply Regulations prior to connection of the product.

Declaration of conformity

Aqualisa Products Limited declares that the Quartz Smart Valve™ and controller, in conjunction with the diverter and wired remote, complies with the essential requirements and other relevant provisions of the Low Voltage Directive (2014/35/EU) and the EMC Directive (2014/30/EU).

After installation

Familiarise the end user with the operation of this product and hand them this guide. Complete and post the guarantee card or register online at www.aqualisa.co.uk

BATH OVERFLOW FILLER COMPONENTS



WALL MOUNTED COMPONENTS



CEILING MOUNTED COMPONENTS





**Ceiling mounted
fixed head**



**Wall mounted
fixed head**



**Quartz™ concealed with
adjustable height head**



**Quartz™ exposed with
adjustable height head**

SYSTEM LAYOUT DIAGRAMS

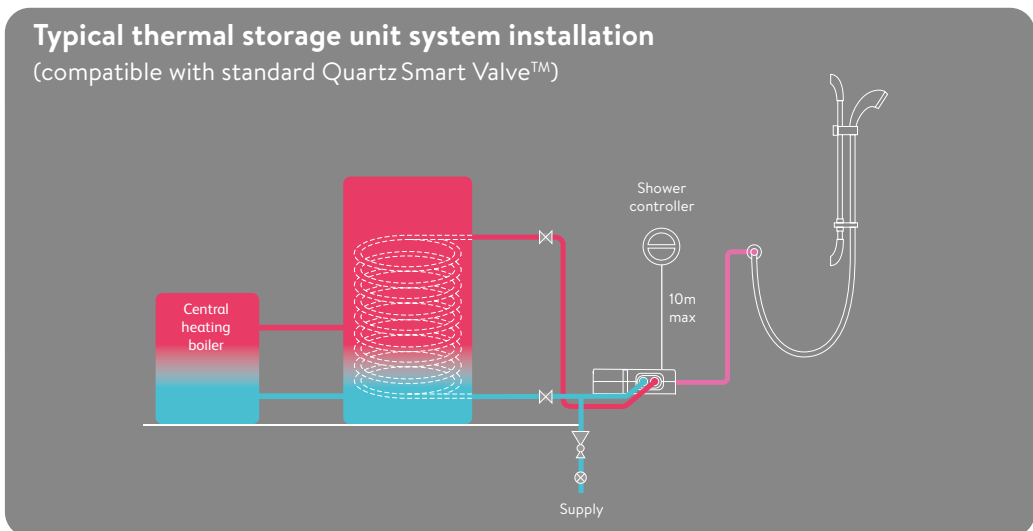
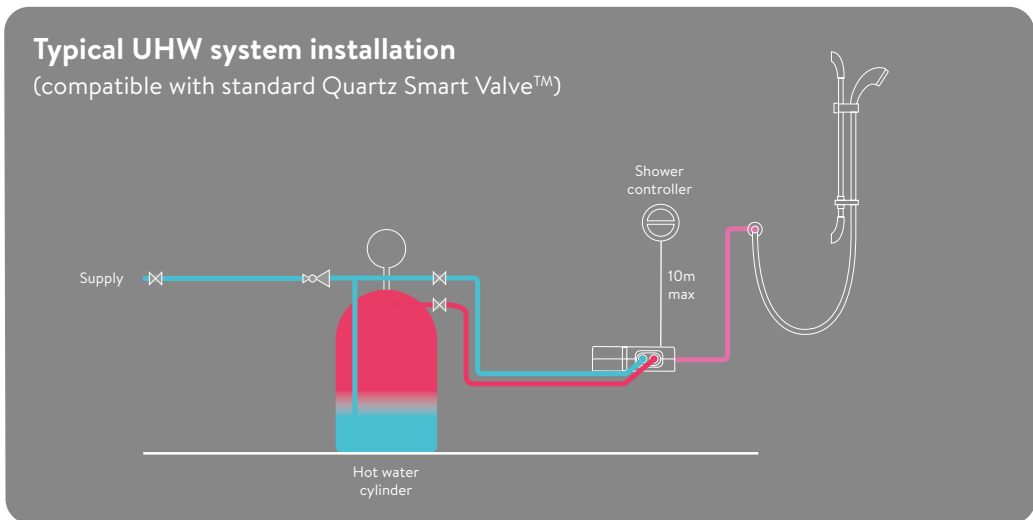
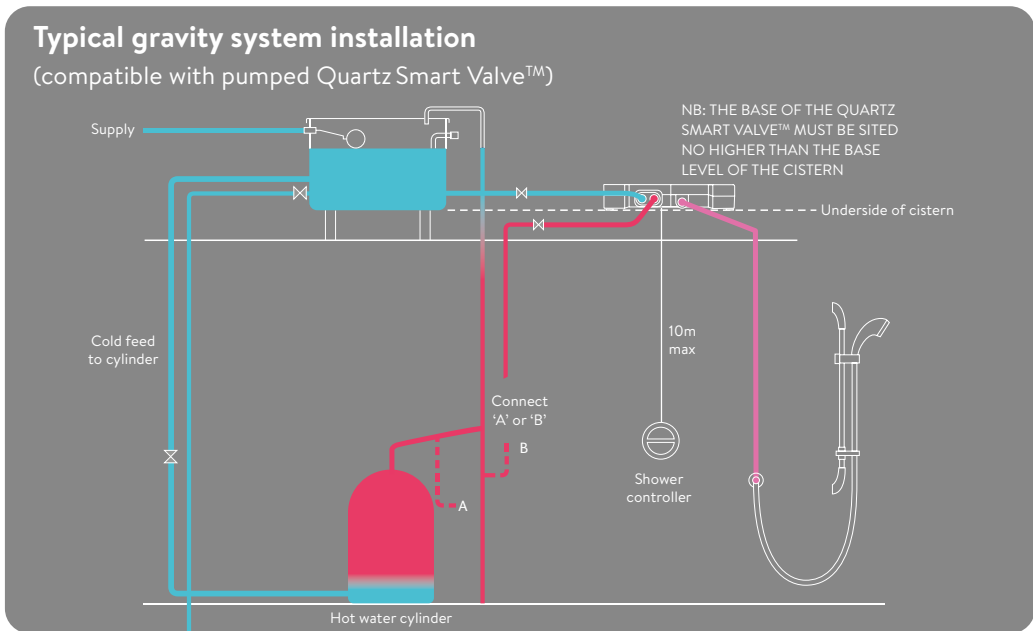

Typical combination boiler installation (compatible with standard Quartz Smart Valve™)

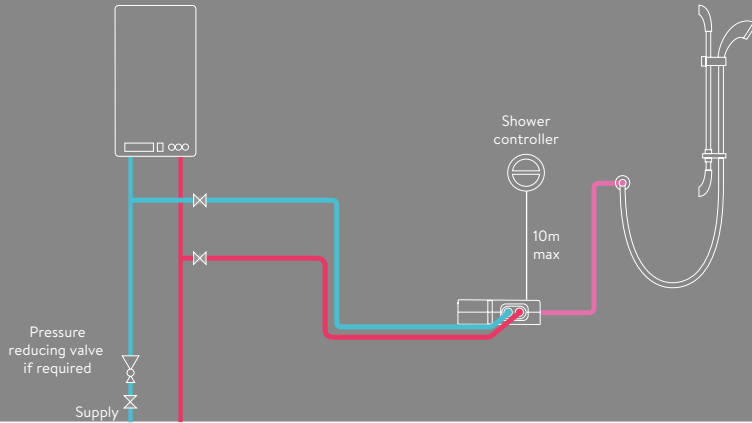

Typical pumped system installation (compatible with standard Quartz Smart Valve™)

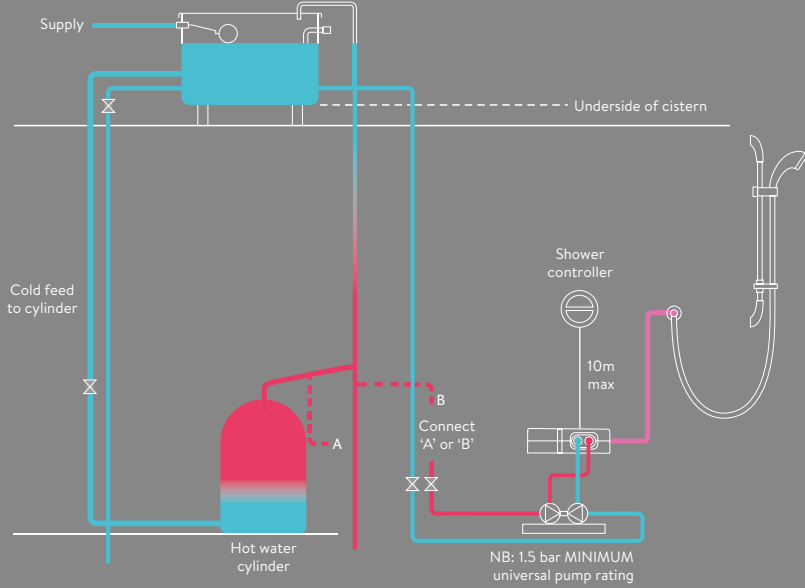

INSTALLATION



This product must be installed by a competent person in accordance with the relevant Water Supply Regulations.

Prior to installation, ensure all additional guides supplied with this product are read and understood.

In addition to the guide below, it is essential that the important information (above) is read and understood and that you have all the necessary components before commencing installation.

The Quartz™ shower system is supplied with universal fixings intended to secure it to a suitable wall.

DIGITAL TV INTERFERENCE

Although the Quartz Smart Valve™ complies with all relevant EMC standards, if incorrectly sited, it may interfere with digital TV reception. Please follow the recommendations below to minimise this effect.

If TV interference is an issue a service kit is available (part no: 652102).

See recommended layouts below.

Images of Quartz Smart Valve™ for illustration only, refer to instruction 1 for orientation.

Valve colour may vary – the Original Quartz™ valve being black, and the Quartz Smart Valve™ being orange.

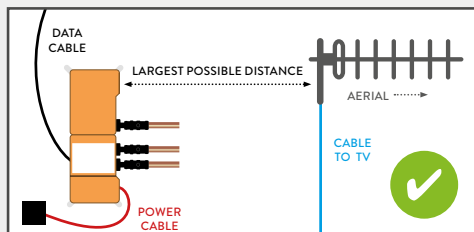

LOWEST PROBABILITY OF INTERFERENCE

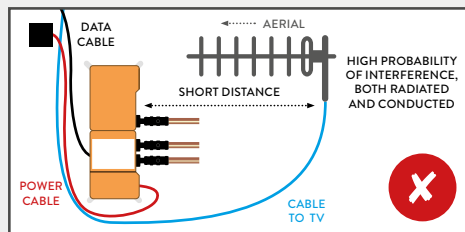

LAYOUT WHICH COULD CAUSE PROBLEMS

- Route cables separately, and as far apart from each other as possible.
- Aerial to point away from the Quartz Smart Valve™.
- Ensure the distance between the Quartz Smart Valve™ and the aerial is as large as possible.



Installation videos are available on our website www.aqualisa.co.uk/installation-videos or alternatively, scan the QR codes on the reverse of this guide.

1

To ensure safe operation and installation of this product, the Quartz Smart Valve™ MUST be installed in one of the orientations shown.

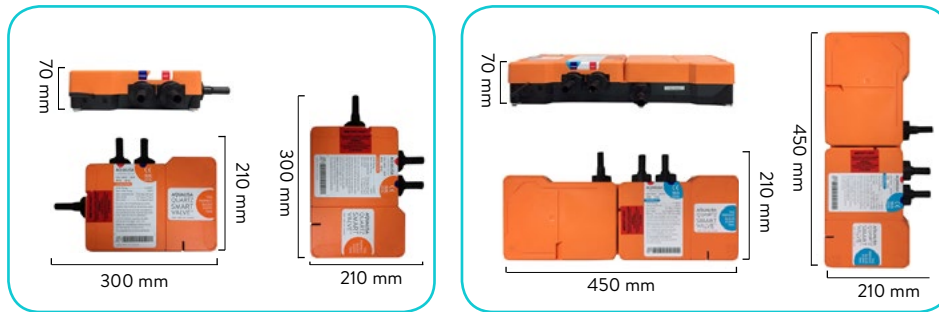

2

Isolation valves are supplied with the Quartz Smart Valve™ and must be fitted on both inlets and the blended water outlet. All pipe work should be run in 15mm pipe. All pipe work should be supported. For gravity fed installations, 22mm pipe work should be run as close to the Quartz Smart Valve™ as possible before reducing down to 15mm.



To ensure optimum performance we recommend using copper pipe with a minimum number of elbows.



The inlet supply centres are 48mm.

Please note arrow on isolation valve to indicate direction of flow.

DO NOT use compression fittings on the inlet and outlet spigots this will affect the warranty if fitted.

3

Choose the position for your Quartz Smart Valve™ as close to the controller as possible. The Quartz Smart Valve™ may be sited in the roof space above the proposed shower site, in the airing cupboard or behind a screwed bath panel if more convenient. For information regarding protecting the Quartz Smart Valve™ from cold/frost, contact Aqualisa Customer Services or refer to the Aqualisa website. Insulation material must not be placed under or on top of the Quartz Smart Valve™, the location should be where freezing cannot occur.

Please refer to the system layout diagrams.



Exposed installation example shown



The Quartz Smart Valve™ Must be sited in a position that is safely accessible for servicing and commissioning purposes. When fitted in a loft space, the route to and the area around the Quartz Smart Valve™ must be boarded to ensure a safe working environment.

The optimum position for the Quartz Smart Valve™ is in the roof space above the controller site to take full advantage of the ease and speed of installation.

The distance between the Quartz Smart Valve™ and the controller must be within the range of the 10m data cable supplied.

4

Place the Quartz Smart Valve™ on a solid mounting surface, and place the fixing feet into suitable positions. Mark, then drill and prepare suitable fixings before securing the Quartz Smart Valve™ to the mounting surface using the screws provided, (if suitable).



5

Flush through both hot and cold supply pipes.



Refer to safety information section
The maximum hot water inlet temperature must be no more than 65°C.

6

Attach the supply pipes to the Quartz Smart Valve™, ensuring that the cold and hot feeds are fitted into the appropriately marked inlets.



Do not solder near to plastic components.



If you have a concealed system continue with instructions 7-12.
If you have an exposed system proceed to instruction 13.

7

Run a pipe from the mixed water outlet of the Quartz Smart Valve™ to the proposed siting for the shower hose outlet, fixed head or diverter depending on the system purchased.



To ensure optimum performance we recommend using copper pipe with a minimum number of elbows.

8

Place the paper template on the wall in the desired location for the controller and mark all fixing points and the data cable entry point. Remove the template and drill a Ø16mm hole at the appropriate position for the data cable.

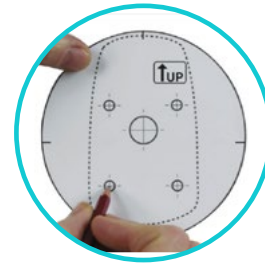

Ensure the data cable is the correct way round as both ends differ in type of connection used (transparent connector to the Quartz Smart Valve™ or diverter).

Data cables must be protected by suitable sheathing or conduit in the event of servicing and maintenance. Failure to install this way may invalidate the warranty.

Care should be taken to ensure the mounting holes do not pierce the data cable conduit.



If installing this Quartz™ product as a replacement product, it may be necessary to purchase a concealed retro-fit wall plate to cover the existing hole in the tiling. The cavity in the wall should be plugged using a suitable material for the wall plate to be secured to. Contact our Customer Service Department to purchase product code: QZD.B3.RWP.14 – Concealed retro-fit wall plate.

9

Drill and prepare the four wall fixings for the controller using the fixings provided, (if suitable).

10

Feed the controller connection end of the data cable through the centre hole in the mounting plate. Run a bead of silicone sealant in the mastic groove on the back of the mounting plate and press into position on the finished wall surface. Ensure the data cable is held securely by the narrow middle slot of the mounting plate and fix to the wall using the brass screws provided.



11

Lining up the key way, push the data cable plug into the back of the controller, ensuring both rubber skirts are recessed into the connection (see diagram below), using a blunt flat bladed screwdriver or similar tool if required. To make a water tight fitting, ensure the rubber seal is no longer visible. Slide the controller onto the mounting plate.



12

Secure the controller onto the mounting plate with the fixing screw located at the base of the controller using a small Pozidriv screwdriver.



To ensure a watertight seal, we recommend running a thin bead of silicone around the concealed controller once it has been secured to the mounting plate.



If you have an exposed system continue with instructions 13-24.
If you have a concealed system proceed to instruction 25.

13

Locate a suitable entry point into the ceiling for the riser rail, avoiding joists and services.



The centre of the riser rail stands 45mm from the wall. If this is not suitable, the spacers provided with the fixing brackets will increase the depth to 70mm from the wall.

14

Drill a hole through the ceiling, a minimum of Ø30mm, maximum Ø40mm.

15

Feed the riser rail assembly containing the supply pipe and data cable through the hole in the ceiling, ensuring the controller is at the desired height, the rail is vertical, and that there is adequate working clearance above the top of the rail in the roof space.



DO NOT use a compression fitting to connect the outlet pipe to the top of the Quartz™ exposed product. This will affect the warranty. The black push fit elbow provided MUST be used.

This connection MUST be sited in a position that is safely accessible for commissioning, servicing and maintenance purposes.



If the ceiling height is over 2.4m (8ft), a riser rail extension kit will be required. Contact our Customer Service Department to purchase a riser rail extension kit (part no: 223217).



16

Temporarily slide the gel hook up the rail ensuring it is positioned above the lower fixing bracket assembly.

17

Place the lower bracket support pillar into position ensuring the locking lug is correctly fitted into the location hole in the rail.



18

Carefully slide the fixing bracket over the rail onto the support pillar.



19

Ensuring the rail assembly has been passed through the hole in the ceiling and is at the desired height, mark the screw holes and remove the fixing bracket.

20

Prepare suitable fixings and slide the fixing bracket back over the rail onto the support pillar. Secure to the wall using the screws provided.

21

Place the upper rail bracket support pillar into the desired location ensuring that both the hose restraint and the Aqualisa Pinch Grip™ holder are below the rail wall bracket.

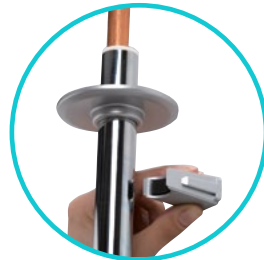

22

Slide the fixing bracket over the rail onto the support pillar and repeat fixing procedures 18-20.

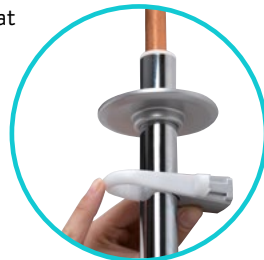

23

Carefully slide the rail end covers onto the fixing brackets flush with the finished wall surface and click the sides firmly into position.



24

Slide the ceiling plate up to the ceiling to cover the entry hole.



The ceiling plate cannot be sited against an uneven surface. If there is coving or an alternative obstruction, please ensure the entry hole is neat and unobtrusive; otherwise the inner tube could be visible within the showering area.



For both concealed and exposed systems continue with instructions 25-27.

25

Connect the outlet pipe to the mixed water outlet on the Quartz Smart Valve™. Using pipe clips as appropriate, ensure that all pipe work is perpendicular to the Quartz Smart Valve™, i.e. not putting any strain on the fittings.



Before any electrical adjustment is attempted, the electricity supply must be turned off at the mains switch.

Electrical installation may only be carried out by a qualified person.

All copper pipe work must be cross-bonded and connected to a reliable earthing point.

26

Connect the Quartz Smart Valve™ power lead to a double pole 3 amp fuse switched spur incorporated in the fixed wiring circuit, in accordance with current wiring rules (refer to safety information section). Ensure that this is located in an accessible, dry location and not in the bathroom.



THIS APPLIANCE MUST BE EARTHED

We recommend protecting surface mounted cables in suitable approved conduit to avoid the risk of damage from vermin.

The power lead should also be clipped in place with 'P' clips or similar to avoid accidents.

27

Loosen the single fixing screw on the top of the Quartz Smart Valve™ and then carefully tilt the lid up and off the location lugs, and set the lid aside.

Plug in the transparent connector of the low voltage, 10m data cable into the socket adjacent to the temperature adjuster as indicated on the label.

Feed the cable out of the Quartz Smart Valve™ ensuring it is correctly routed within the data cable channel.

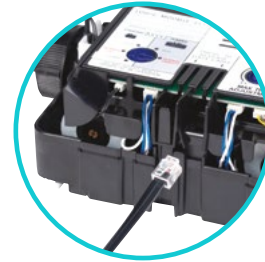

A further data cable socket has been provided for use with a wired remote or diverter. This can be accessed by carefully snapping and removing the entry pillar and connecting the cable as described above. Please refer to the Wired Remote Installation Guide or Diverter Installation Guide for the relevant wiring diagrams.



For concealed products, fit the shower head system following the installation instructions overleaf, then proceed to point 31.

For exposed products continue with instructions 28-30.

28

Ensuring the hose washers are fitted at either end of the shower hose, attach the hose to the male thread located underneath the controller.

Connect the power to the Quartz Smart Valve™ and press the 'Start/Stop' button on the controller to turn the shower on.

Run the shower for 15 seconds to clear any debris and flush the system through. Turn the shower off and isolate from the electrical supply.



29

Thread the shower hose through the hose restraint.



30

Ensuring the hose washer is in the correct position, depress the anti-swivel locking button on the handset and secure the handset to the hose, then place the handset into the Aqualisa Pinch Grip™ holder.



For both concealed and exposed systems please follow the remaining instructions.



31

The Quartz Smart Valve™ is supplied factory set to either 'NORMAL HP' mode or 'NORMAL GRAVITY' mode depending on which product has been ordered.

BALANCED HP SYSTEMS AND SEPARATELY PUMPED GRAVITY SYSTEMS:

The standard Quartz Smart Valve™ fits to balanced high pressure systems or separately pumped gravity systems. It may be set to 'NORMAL HP', or for water economy, 'ECO HP' mode.

STANDARD COMBINATION BOILER SYSTEMS:

When installed on combi boiler systems, the standard Quartz Smart Valve™ should be set to 'COMBI' mode for optimum performance.

GRAVITY PUMPED QUARTZ SMART VALVE™ :

The gravity pumped Quartz Smart Valve™ installed on gravity systems ONLY may be set to 'NORMAL GRAVITY', or for water economy, 'ECO GRAVITY' mode.



The 'ECO' flow rate mode should NOT be selected for shower or bath systems fitted to combination boilers.



When making any adjustment to the Quartz Smart Valve™ settings the power MUST be isolated.

32

Reinstate the electrical supply to the Quartz Smart Valve™. Press the 'Start/Stop' button on the controller to turn the shower on.

33

Run the shower at maximum temperature (factory pre set to 45°C). If required, maximum temperature adjustment can be made with a flat bladed screwdriver using the 'MAX TEMP ADJUSTMENT' control as indicated. When the temperature has been set to the desired position, carefully replace the Quartz Smart Valve™ lid and secure the fixing screw, hand tight only.



Site conditions can affect temperature settings, installer to adjust as required.

INSTALLATION

ADJUSTABLE HEIGHT HEADS



Installation videos are available on our website www.aqualisa.co.uk/installation-videos or alternatively, scan the QR codes on the reverse of this guide.

1

Ensure the finished wall surface is even, prepare pipework from the Quartz Smart Valve™ or diverter to the required position for the hose outlet using a Ø15mm copper pipe. Slide the wall spacer down the projecting pipe flush with the finished wall surface.

2

Slide the 15mm gripper ring down the projecting pipe flush with the wall spacer fitting.



3

Trim the projecting pipe to a length of 15-22mm, measured from the face of the gripper ring, using a rotary type cutter. If a hacksaw is used, the pipe end must be carefully de-burred and chamfered.

4

Clean and lubricate the pipe using a suitable (silicone based) lubricant.

5

Remove the locking screw, rotate the chrome outlet assembly and remove the outlet from the wall mounting plate.



6

Ensuring the locking screw hole is positioned at the bottom, place the wall outlet mounting plate onto the pipe assembly and mark and prepare the fixing points, using the fixings provided, (if suitable).



7

Secure the wall mounting plate to the wall using the screws provided, (if suitable).



8

Place the 'O' ring on the recess of the spigot section on the mounting plate, offer the wall outlet onto the mounting plate in the 5 o'clock position and rotate clockwise until a stop is reached.

9

Refit the locking screw taking care not to overtighten.



9

Refit the locking screw taking care not to overtighten.



10

Prepare two fixing points between 520mm (minimum) and 830mm (maximum) apart using the fixings provided, if suitable.



The top rail end bracket can be adjusted to suit existing screw holes in the finished wall by sliding the bracket up or down the rail to suit the required position.

11

Pass the rail through the Aqualisa Pinch Grip™ holder while keeping the slider levers depressed.



12

Carefully slide the gel hook onto the rail under the Aqualisa Pinch Grip™ holder.



Current Water Supply Regulations state that the handset should not be allowed to pass a point 25mm above the spill over level of the bath or shower tray. If this cannot be achieved, the hose must be passed through the gel hook which has been designed to be utilised as a hose restraint.

13

Secure the top rail bracket into position using the screws provided, (if suitable).



14

Attach the bottom rail end body onto the rail.

15

Slide the rail assembly up through the top rail end body.



16

Align the small hole in the rail with the bottom rail end fixing point. Secure the rail assembly to the wall, using the fixings provided, if suitable, taking care to not over tighten.

17

Place the rail end caps into the rail ends and push firmly into position.



18

Ensuring the hose washer is in the correct position; attach the hose to the wall outlet. Run the shower for a few seconds to clear any debris that may be present.



19

Pass the hose through the gel hanger.



20

Ensuring the hose washer is in the correct position, depress the anti-swivel locking button on the handset and secure the handset to the hose, then place the handset into the Aqualisa Pinch Grip™ holder.



WALL MOUNTED HEAD



Installation videos are available on our website www.aqualisa.co.uk/installation-videos or alternatively, scan the QR codes on the reverse of this guide.

1

Run a 15mm outlet pipe from the Quartz Smart Valve™ /diverter to the preferred position for the fixed head.

2

Cut the outlet pipe to the finished length (55mm – 150mm measured from the finished wall surface) using a rotary type cutter. If a hacksaw is used, the pipe end must be carefully de-burred and chamfered.

Slide the wall spacer down the projecting pipe flush with the finished wall surface.

3

Slide the 15mm gripper ring down the projecting pipe flush with the wall spacer fitting.



4

Ensure the pipe is clean and free of dust and slide the fixing bush onto the pipe flush with the finished wall surface.



5

Slide the fixed head arm over the fixing bush flush with the wall surface and mark the four fixing points.

6

Carefully remove the fixed head arm and drill and prepare using the fixings provided, if suitable, taking care to avoid pipework hidden in the wall.

7

Ensure the fixing bush is clean and free of dust, fit the 15mm 'O' ring against the end of the fixing bush. Lubricate the 'O' ring using a suitable silicone based lubricant.

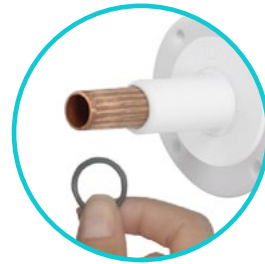

The 'O' ring must be positioned on the 15mm pipe flush to the fixing bush, not onto the fixing bush shaft.

8

Refit the shower arm and secure it to the wall using the screws provided.



9

Run the shower for a few seconds to clear any debris that may be present.

10

Slide the cover plate into position flush with the finished wall surface.



11

Ensuring the rubber washer is in the correct position, attach the shower head to the fixed arm and carefully secure using a suitable spanner, or a tool with smooth jaws, sufficiently to lock the head into position.



CEILING MOUNTED HEAD



The ceiling mounted fixed head is supplied with screws for fixing the product to a noggin. A NOGGIN MUST BE USED AS PART OF THIS INSTALLATION.



Installation videos are available on our website www.aqualisa.co.uk/installation-videos or alternatively, scan the QR codes on the reverse of this guide.

1

Run a 15mm outlet pipe from the Quartz Smart Valve™ /diverter to the preferred position for the fixed head.

2

Locate the position for the fixed head in the bathroom and firstly drill a pilot hole to mark the position before checking that there is suitable space behind the ceiling for the fixing assembly.



The minimum height required behind the ceiling is 50mm and the space must allow for an 80mm wide, 50mm deep noggin to be used to support the assembly.

3

Drill a hole (minimum $\varnothing 28\text{mm}$, maximum $\varnothing 40\text{mm}$) through the ceiling and the noggin.

4

Remove the fixing bracket carefully from the fixed head arm.

5

Set the fixing bracket into position and mark the fixing points. Remove the bracket and drill and prepare suitable fixings. Refit the fixing bracket and secure it through the ceiling and into the noggin using the screws provided, (if suitable).



6

Feed the arm through the fixing bracket to the correct depth. Tighten the nut using a 32mm spanner if necessary to facilitate.

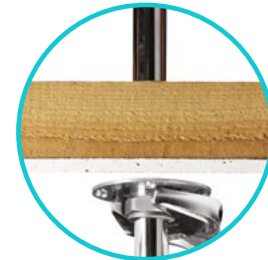

7

Cut off the excess pipe allowing for a suitable working length to allow for the required 22mm connection. If a push fit connector is to be used then the pipe must be abraded to remove all chrome plating.

8

Connect the pipe work from the Quartz Smart Valve™ /diverter to the end of the fixed head pipe using a suitable coupling. Fully tighten the nut on the ceiling mounting bracket using a 32mm spanner if necessary to facilitate.



Run the shower for a few seconds to clear any debris and to check for any leaks.

9

Lubricate the 'O' ring if necessary and carefully slide the cover plate back over the fixed head arm and into position against the ceiling.



10

Secure the cover plate to the arm using the grub screw and 2.5mm hexagonal key provided.



11

Ensuring the rubber washer is in the correct position, attach the shower head to the fixed arm and carefully secure using a suitable spanner, or a tool with smooth jaws, sufficiently to lock the head into position.



BATH OVERFLOW FILLER



The bath overflow filler is suitable for baths up to a maximum thickness of 24mm.



Installation videos are available on our website www.aqualisa.co.uk/installation-videos or alternatively, scan the QR codes on the reverse of this guide.

1

Carefully unscrew and remove the overflow filler outlet from the body assembly and set aside.



2

Carefully unscrew and remove the bath waste clicker assembly from the waste body and set aside.



3

Offer the bath waste into position ensuring the rubber washer is correctly aligned between the waste assembly and the bath base.



4

Ensuring the rubber washer is correctly aligned, pass the bath waste clicker through the bath and secure to the waste body assembly.



5

Connect the bath waste to a suitable waste pipe.

6

Offer the outlet body assembly into position at the rear of the bath ensuring the rubber washer is correctly aligned between the outlet body assembly and bath wall.



7

Ensuring the rubber washer is correctly aligned, pass the overflow filler outlet through the bath and secure to the body assembly.



8

Remove the relevant inlet blanking plug and attach the flexible hose to the blended inlet connection.



PTFE thread tape **MUST** be used to guarantee a watertight seal.

9

Connect the flexible hose to the blended supply pipe ensuring suitable non restrictive double check valves (not supplied) are fitted in line with current Water Supply Regulations.

WASTE PIPE EXTENSION KIT



If required for larger baths, a 900mm waste pipe conversion kit is available from the Aqualisa Customer Service department. Please contact our Customer Service Department on 01959 560010.

1

Unscrew the clamping nut and remove the waste pipe from the waste assembly.



2

Remove the clamping nut and sealing washer from the waste pipe and set aside.

3

Carefully cut down the length of the waste pipe, and disconnect from the outlet assembly, ensuring not to damage the outlet.

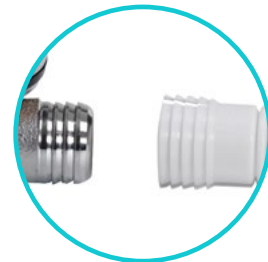

4

To reassemble, push the longer waste pipe into position over the outlet, and secure it in place using a jubilee clip (not supplied).

NOTE: The waste pipe may need to be softened by running it under hot water, to ensure it slides over the outlet.

USER GUIDE



To avoid residual water dripping from the shower head after use, we advise to tilt the head to allow residual water to drain out.

The above recommendation applies to both adjustable and fixed shower heads.



If you have a dual outlet diverter product, please refer to the controller user guide in the Diverter Installation Guide.

Controller user guide – single outlet

1. Turn the temperature dial to the required setting.
2. Press the 'Start/Stop' button on the controller, to turn the shower on.
3. The blue LED display will flash until the selected temperature has been reached. When the LED display is constant, step into your shower and enjoy!
4. The temperature may be adjusted whilst in the shower.
5. Press the 'Boost' button on the controller to increase the flow of the shower when desired. To turn 'Boost' off, press the 'Boost' button again at any time.
N.B. The strength of the 'Boost' button will vary depending on the water system pressure and the configuration of the pipework.
6. Press the 'Start/Stop' button on the controller, to turn the shower off.



Adjustable head user guide

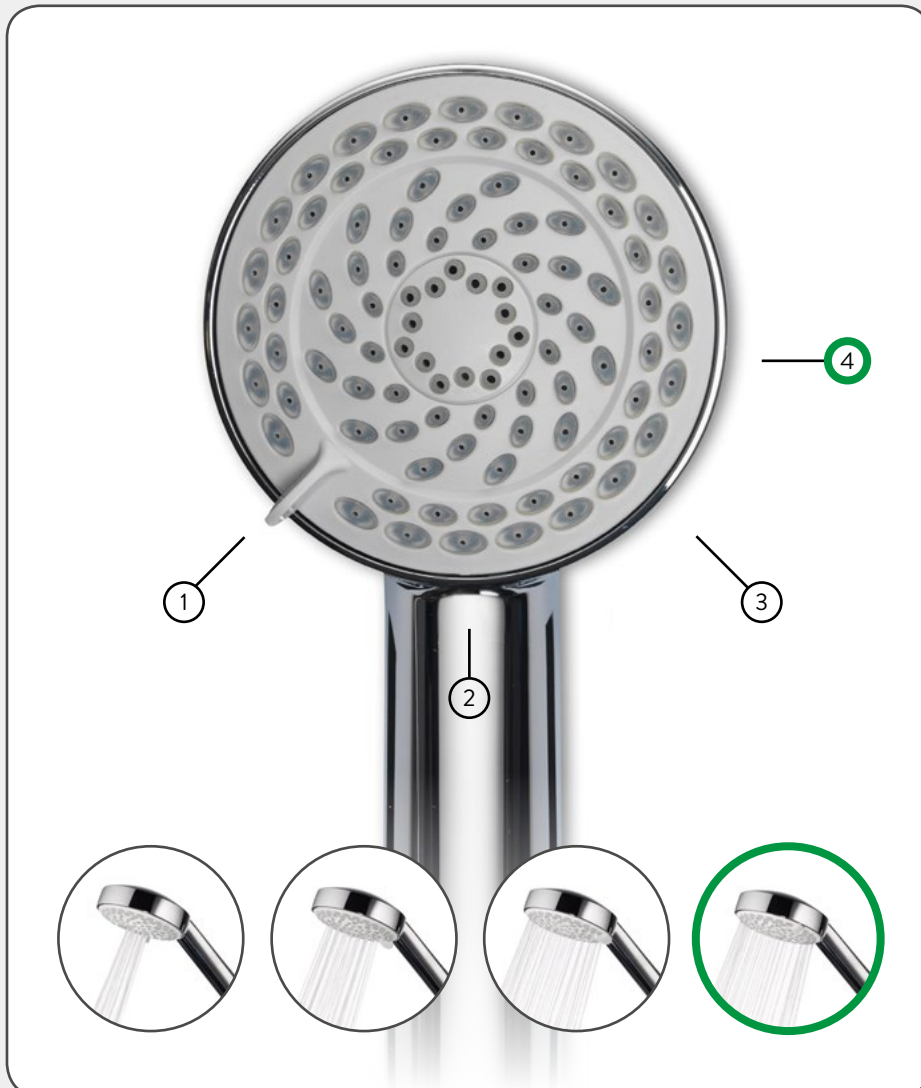

1. Rotate the spray plate lever clockwise or anti-clockwise to select the desired spray pattern.

When the lever is in position 4, the water saving 'Eco' mode is selected. This provides the same spray pattern as position 3, but, depending on which water system the product is fitted to, offers up to 25% water saving.



2. To select the preferred height for the shower head, depress the levers fully to enable the Aqualisa Pinch Grip™ holder to be moved up or down the rail.



3. Angular adjustment is made by carefully but firmly pulling forwards or pushing back the shower head against the knuckle ratchet in the holder.



Fixed head user guide

The angle of the fixed shower head can be adjusted. The shower head is mounted on a multi directional ball joint to allow for angular adjustment in any direction by carefully holding the shower head and moving the head to the desired angle.



Bath overflow filler user guide

1. Push the waste cover to engage the plug fitting.
2. Push the waste cover again to disengage the plug fitting.



Please do not leave the bath filler running unattended. Although the overflow will remove excess water once the bath is overflowed, this may not be sufficient to prevent the bath from overflowing (depending on system conditions). If you have any queries regarding the installation of this product please contact the Aqualisa Customer Service Department on 01959 560010.

Cleaning and maintenance

Your Quartz™ system should be cleaned using only a soft cloth and washing up liquid.

Your Quartz™ bath system 'click clack' waste plug mechanism, if applicable, should be kept clear of debris to ensure the plug maintains a watertight seal. The plug can be unscrewed and removed to check and clean the mechanism.

DO NOT USE ABRASIVE CLEANERS

To reduce the need for chemical descaling in hard water areas, your shower head incorporates a 'clear flow' system, whereby any scale build up can be broken down by gently rubbing the flexible tips of the jets during use. This procedure should be completed regularly, as often as once a week in some hard water areas, as scale build up can affect the spray pattern and cause the shower to perform poorly.

Failure to descale the shower head can affect the internal seals and may affect the warranty. Cleaning and maintenance should not be undertaken by children without supervision by a person responsible for their safety.

Should chemical descaling of the head become necessary, remove the shower head fully and immerse in a mild proprietary descaler.



It is imperative that descaling is carried out in accordance with the manufacturer's instructions, substances that are not suitable for plastics and electroplated surfaces must not be used.

Scan for Installation Videos



Quartz™ concealed



Quartz™ exposed



Rail kit



Wall mounted
fixed head



Ceiling mounted
fixed head



Quartz™ bathfill

AQUALISA

Aqualisa Products Limited
The Flyers Way
Westerham Kent TN16 1DE
Customer Helpline: 01959 560010
Brochure Hotline: 0800 652 3669
Website: www.aqualisa.co.uk
Email: enquiries@aqualisa.co.uk
Republic of Ireland
Sales enquiries: 01-864-3363
Service enquiries: 01-844-3212



Please note that calls may be recorded for training and quality purposes.

The company reserves the right to alter, change or modify the product specifications without prior warning.

™ Trademark of Aqualisa Products Limited.



Intertek



Part No: 704023 Issue 03 Dec 18

AQUALISA

DIVERTER INSTALLATION GUIDE



IMPORTANT INFORMATION

Safety information

This appliance can be used by children aged from 3 years and above and persons with reduced physical, sensory or mental capabilities or lack of experience and knowledge if they have been given supervision or instruction concerning use of the appliance in a safe way and understand the hazards involved.

Children shall not play with the appliance.

Cleaning and user maintenance shall not be made by children without supervision.

This product must be installed by a competent person in accordance with all relevant current local and national Water Supply Regulations.

ALL PRODUCTS REQUIRING AN ELECTRICAL CONNECTION MUST BE INSTALLED BY A QUALIFIED PERSON FOLLOWING THE LATEST REVISION OF THE ELECTRICAL WIRING REGULATIONS, BOTH NATIONAL AND LOCAL AND CERTIFIED TO CURRENT BUILDING REGULATIONS.

This system should be installed so that other taps or appliances operated elsewhere within the premises do not significantly affect the flow.

The Quartz Smart Valve™ must not be used with a hot water supply temperature of over 65°C. If the maximum hot water temperature is likely to rise above 65°C then a Thermostatic Blending Valve must be used.

The Quartz Smart Valve™ is supplied factory pre-set at maximum temperature of 45°C. The maximum temperature is fully adjustable to suit site conditions. If adjusted, we recommend the outlet temperature is set to a MAXIMUM of 46°C.

The Quartz Smart Valve™ must be installed in an accessible location for servicing and maintenance.

The Quartz Smart Valve™ must not be installed in situations where either the ambient temperature is likely to exceed 40°C or where freezing may occur.

The controller must not be installed in situations where the ambient temperature is likely to fall below 5°C or rise above 40°C.

We do not recommend the use of a controller in steam therapy facilities.

This appliance must be earthed.

Cables must be protected by a suitably sized conduit or trunking to avoid risk of damage and to allow removal for service and maintenance purposes.

Ensure that the conduit is run to avoid the controller fixing holes.

Surface mounted cables must also be protected by a suitable approved conduit, even in a loft, where there may be a risk of damage from vermin.

The power lead must only be replaced by the manufacturer or his accredited agent.

The controller is supplied from a safety low voltage source.

This product is suitable for domestic use only.

Aqualisa products are supplied complete with a 1 year guarantee that can be upgraded by registering the product with Aqualisa.

See www.aqualisa.co.uk/guarantee for details.

Installation of the pumped Quartz Smart Valve™ (for gravity stored systems)

The pumped Quartz Smart Valve™ shower system is designed to operate up to a maximum static pressure of 100kPa ((1 bar)(10 metres head)(14.5psi)). Under no circumstances must the pumped Quartz Smart Valve™ be connected directly to the water main or in line with another booster pump.

The minimum actual capacity of the cold water storage cistern should be not less than 225 litres (50 gallons). The capacity of the hot water cylinder must be capable of meeting anticipated demand.

Installation of the standard (unpumped) Quartz Smart Valve™ (for balanced high pressure and unvented systems, combination boiler systems and separately pumped gravity systems)

Pressures: The standard (unpumped) Quartz Smart Valve™ is designed to operate up to a maximum static pressure of 700kPa ((7 bar)(100psi)). Where pressures are likely to exceed 700kPa ((7 bar)(100psi)), a pressure reducing valve must be fitted to the incoming mains supply. A setting of 400kPa ((4 bar)(60psi)) is recommended. It should be noted that daytime pressures approaching 600kPa ((6 bar)(80psi)) can rise above the stated maximum overnight.

Special notes for combination boiler systems

The appliance must have a minimum domestic hot water rating of 24kW and be of the type fitted with a fully modulating gas valve.

If in any doubt, please contact the appliance manufacturer before installation commences.

PLEASE NOTE: DUE TO PERFORMANCE CHARACTERISTICS OF COMBINATION BOILERS, SEASONAL INLET TEMPERATURE CHANGE WILL AFFECT THE QUARTZ SMART VALVE™ OUTLET FLOW RATE RESULTING IN VARYING SHOWER FLOW RATE AND FLOW CONTROL RANGE. INLET TEMPERATURE CHANGE MAY ALSO CAUSE THE TEMPERATURE DISPLAY TO FLASH; THIS IS NOT NECESSARILY CHANGING THE OUTLET TEMPERATURE.

Special notes for separately pumped gravity systems and universal/negative head pumps (for divert systems)

We recommend a **MINIMUM** pump rating of 1.5 bar. For optimum performance a 2.5 bar pump should be used for all separately pumped installations.

A twin ended pump is required for use with single outlet products.

A universal/negative head type twin ended pump (works on both positive and negative head conditions) **MUST** be used with divert products.

The minimum actual capacity of the cold water storage cistern should be not less than 225 litres (80 gallons). The capacity of the hot water cylinder must be capable of meeting the anticipated demand.

THIS PRODUCT IS NOT SUITABLE FOR USE WITH A SINGLE ENDED PUMP.

Connections

This product incorporates 15mm 'push-fit' type connections. Tube should be cut using a rotary type cutter and lubricated using a silicone grease, petroleum jelly, or similar, prior to insertion into the fitting. 15mm pipework must be used to connect the product.

If plastic pipe is used, the tube insert must not increase the tube diameter or extend the cut-off length by more than 2mm.

THESE FITTINGS ARE NOT SUITABLE FOR STAINLESS STEEL TUBE. COMPRESSION FITTINGS MUST NOT BE USED.

Pipe sizing

PLEASE NOTE: Check pipe size requirements for connections to outlets and accessories.

Long pipe runs, on both inlet and outlet, will reduce the flow rate at the shower head, 22mm pipe work should be used on inlets and reduce down to 15mm as close to the valve as possible to reduce pressure losses and help maintain flow rate. If using 15mm pipe, copper pipe is preferred, to optimise performance minimise the number of elbows used. If long pipe runs are unavoidable on the outlet, use copper pipe rather than plastic, particularly if a diverter is used, and minimise the number of elbows as the pipe inserts are very restrictive.

Flushing

Some modern fluxes can be very corrosive and, if left in contact, will attack the working parts of this unit. All soldering must be completed and the pipe work thoroughly flushed out in accordance with current local and national Water Supply Regulations prior to connection of the product.



Declaration of conformity

Aqualisa Products Limited declares that the diverter, in conjunction with the Quartz Smart Valve™ and controller, complies with the essential requirements and other relevant provisions of the Low Voltage Directive (2014/35/EU) and the EMC Directive (2014/30/EU).

After installation

Familiarise the end user with the operation of this product and hand them this guide. Complete and post the guarantee card or register online at www.aqualisa.co.uk

COMPONENTS

In addition to the components featured within the main product system installation guide, diverter systems also include the following components.



Along with the above components, your main controller will have divert buttons, as shown below.



Exposed dual outlet controller/rail assembly



Concealed dual outlet controller

Quartz™ images shown for illustrative purposes only.

SYSTEM LAYOUT DIAGRAMS

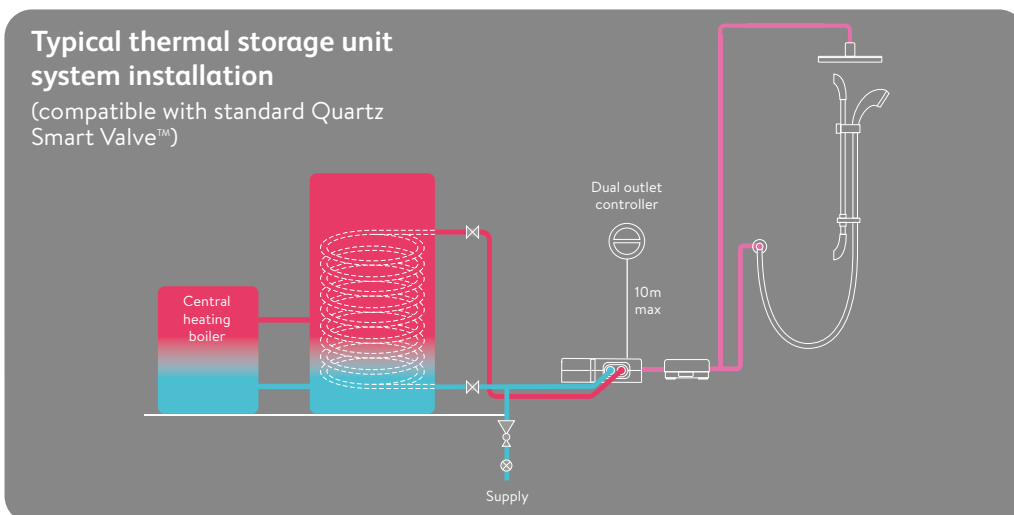
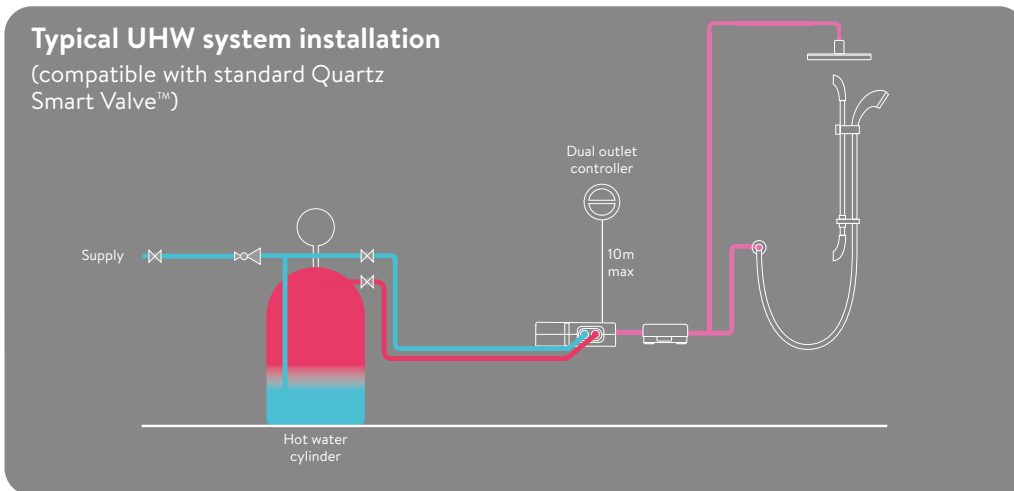
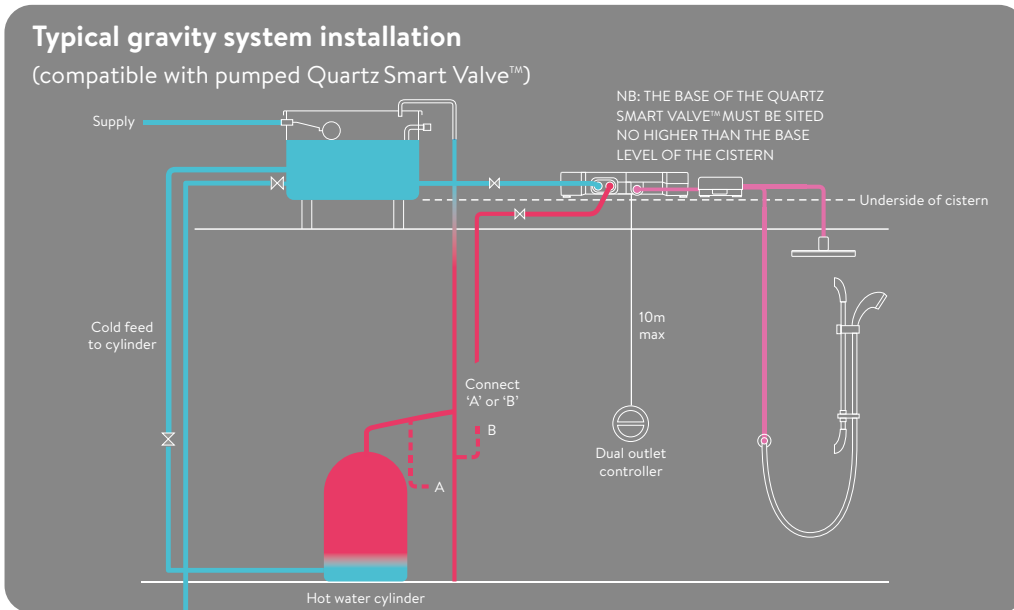

Typical combination boiler installation

(compatible with standard Quartz Smart Valve™)

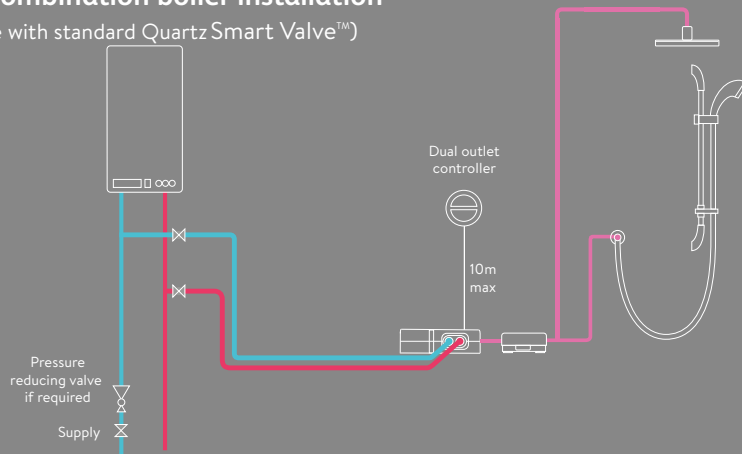

Typical pumped system installation

(compatible with standard Quartz Smart Valve™)

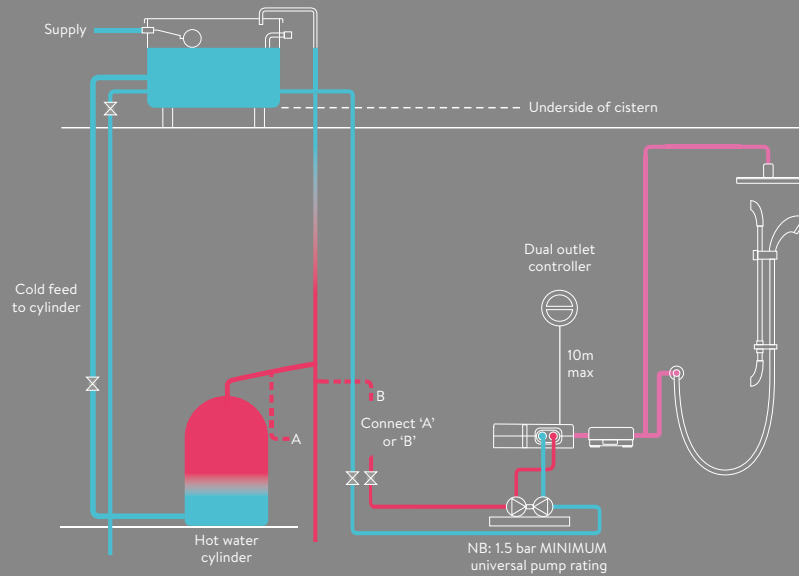

INSTALLATION



This product must be installed by a competent person in accordance with the relevant Water Supply Regulations.

Prior to installation, ensure all additional guides supplied with this product are read and understood.

Fit the Quartz Smart Valve™, controller and outlets following the installation instructions provided separately.

Prior to connecting the blended supply connections to the shower/bath fittings, follow the procedure below to install the diverter.

DIGITAL TV INTERFERENCE

Although the Quartz Smart Valve™ complies with all relevant EMC standards, if incorrectly sited, it may interfere with digital TV reception. Please follow the recommendations below to minimise this effect.

If TV interference is an issue a service kit is available (part no: 652102).

See recommended layouts below.

Images of Quartz Smart Valve™ for illustration only, refer to main installation guide for orientation.

Valve colour may vary – the Original Quartz™ valve being black, and the Quartz Smart Valve™ being orange.

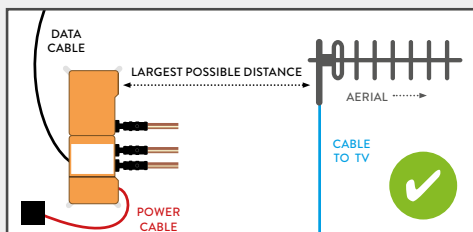

LOWEST PROBABILITY OF INTERFERENCE

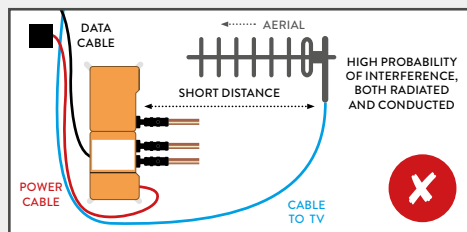

LAYOUT WHICH COULD CAUSE PROBLEMS

- Route cables separately, and as far apart from each other as possible.
- Aerial to point away from the Quartz Smart Valve™.
- Ensure the distance between the Quartz Smart Valve™ and the aerial is as large as possible.



Installation videos are available on our website www.aqualisa.co.uk/installation-videos or alternatively, scan the QR codes on the reverse of this guide.

1

To ensure safe operation and installation of this product, the diverter **MUST** be installed in one of the orientations shown.

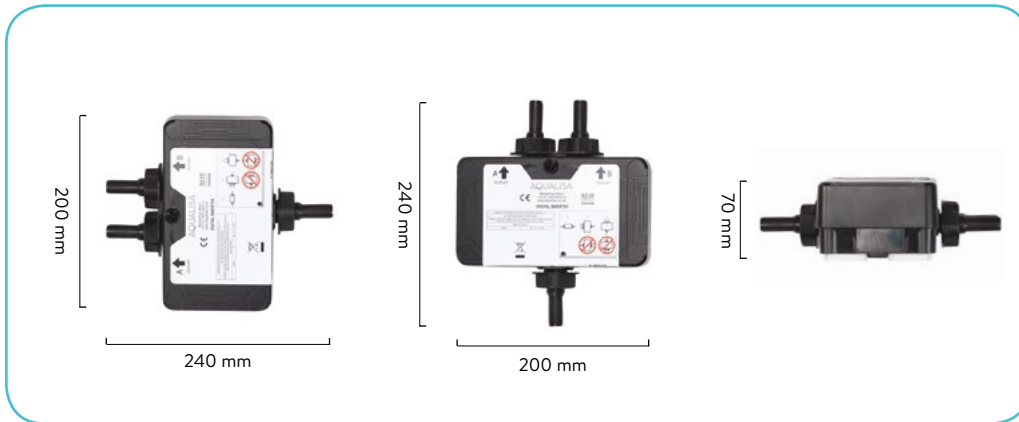

2

In addition to the isolation valves supplied with the Quartz Smart Valve™, isolation valves are also provided for use with the diverter inlet and outlets. All pipe work should be run in 15mm pipe and all pipe work should be supported.



For optimum performance use copper pipe and minimise the pipe length runs and amount of elbow fittings.

3

Choose the position for your diverter as close to the Quartz Smart Valve™ as possible, within range of the 2m low voltage connecting data cable provided. Like the Quartz Smart Valve™, the diverter may be sited in the roof space above the proposed shower/bath site, in the airing cupboard or behind a screwed bath panel if more convenient. If siting in the roof space, ensure that freezing cannot occur and that no insulation material is placed under or over the diverter and Quartz Smart Valve™.



The diverter inlet has been designed, to enable connection directly inline with the HP/ Combi Quartz Smart Valve™ outlet isolation valve connection, or off the Gravity Pumped Quartz Smart Valve™ outlet, using the cranked elbow connector.

The distance between the diverter and Quartz Smart Valve™ must be within the 2m range of the patch lead data cable provided.

The Quartz Smart Valve™ and diverter must be sited in a position that is safely accessible for servicing and maintenance purposes. When fitted in the loft space, the route to and the area around the Quartz Smart Valve™ and diverter must be boarded to ensure a safe working environment.

4

Place the diverter onto a solid mounting surface, adjusting the fixing feet into suitable positions. Mark then drill and prepare suitable fixings before securing it to the mounting surface using the screws provided, (if suitable).



5

Ensuring the supply pipe work connections have been flushed through in accordance with the main installation instructions provided, connect the Quartz Smart Valve™ outlet pipe to the diverter inlet pipe.



Please note direction of arrow on isolation valve to indicate direction of flow.

HP/Combi



Quartz Smart Valve™ connected to diverter with additional pipe



Quartz Smart Valve™ connected directly to diverter

Gravity Pumped



Quartz Smart Valve™ connected to diverter with additional pipe



Quartz Smart Valve™ connected directly to diverter



Images shown are aerial views and are for illustrative purposes only.

6

Ensure that the isolation valves are connected to the diverter outlets, with the arrows correctly aligned according to the direction of flow.



7

Run the pipes from the mixed water outlets on the diverter through to the proposed siting for the shower hose outlet, fixed head arm or bath outlet, depending on the system chosen.



Before any electrical adjustment is attempted, the electricity supply must be turned off at the mains switch.

Electrical installation may only be carried out by a qualified person.

All copper pipe work must be cross-bonded and connected to a reliable earthing point.

8

Unscrew the single fixing screw from the diverter lid, and carefully pull the lid clear.



Wiring diagram

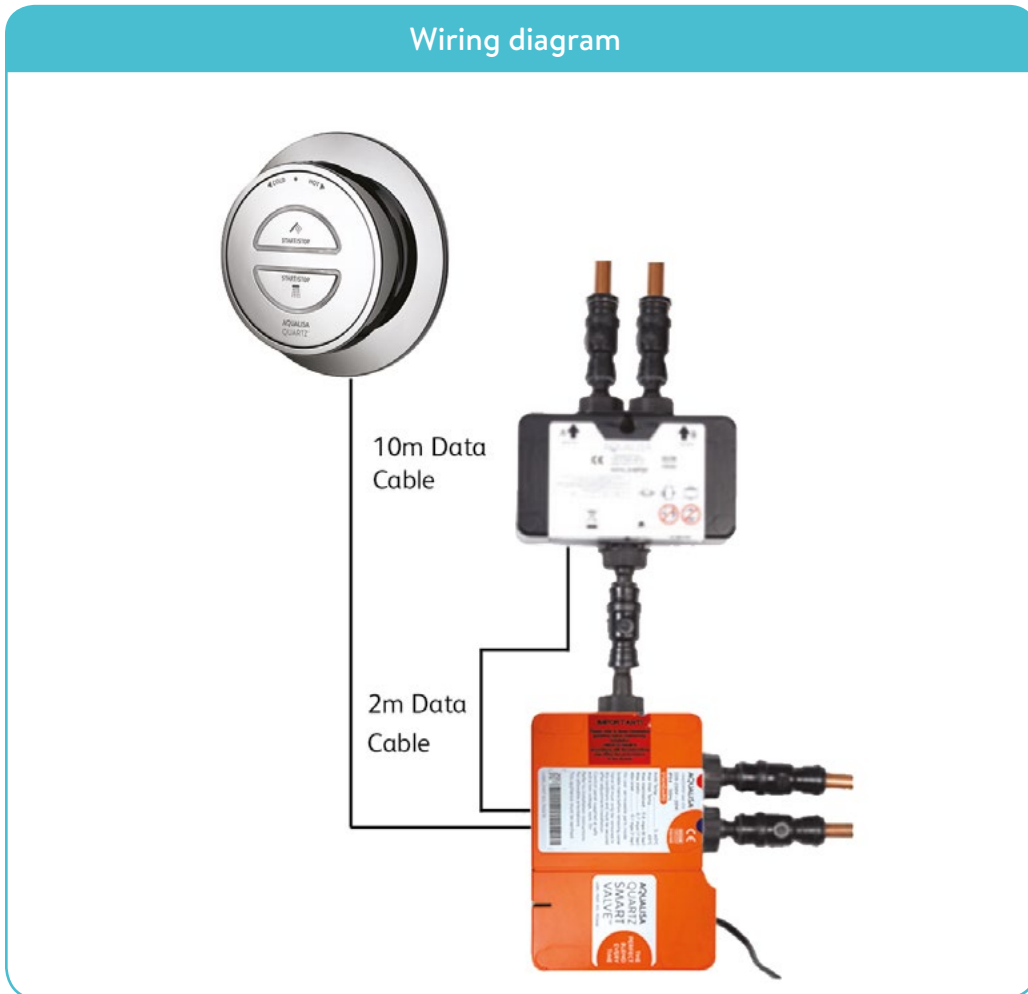

9

Plug the end of the 10m low voltage data cable feeding from the controller, into the open entry port on the main Quartz Smart Valve™.

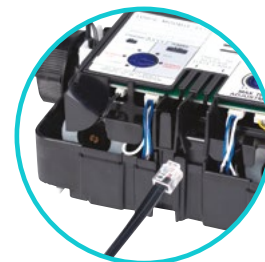

10

Plug one end of the 2m data cable (supplied with the diverter) into the secondary entry port of the main Quartz Smart Valve™, this can be accessed by carefully snapping off and removing the entry pillar.



11

Plug the other end of the 2m data cable (supplied with the diverter) into port 1 on the diverter, this is indicated by the single dot.



If fitting this system complete with a wired remote, a further data cable socket has been provided within the diverter. The wired remote **MUST** be connected here and **NOT** within the main Quartz Smart Valve™.

Please refer to the Wired Remote Installation Guide for the relevant cable configuration.

12

Resume installation following the main and shower/bath fitting installation instructions provided prior to completing the commissioning procedure.

USER GUIDE

Quartz™ controller user guide

Your Quartz™ dual outlet controller has a High flow/Low flow function available. Please note the factory default setting is Low flow on both outlets.

Please see 'Setting flow rate' to change flow settings.

1. Turn the temperature dial to the required setting. The temperature can be adjusted at anytime by turning the dial.
2. Press the desired outlet button on the controller to turn the shower on.



If the 2nd outlet button is pressed, the 1st outlet will automatically stop and the 2nd outlet will start. Depending on system pipe runs, there may be a slight outlet temperature change when switching between outlets.

3. The blue LED display will flash until the selected temperature has been reached.
4. When the LED display is constant, your shower is ready to use.
5. Press the active button to turn the shower off.

Setting flow rate

1. Ensuring the Quartz Smart Valve™ is powered, but without any outlets flowing, enable 'Setup' mode by first turning the temperature dial to full cold. Press and hold both buttons together for 5 seconds.



The LEDs will flash twice quickly and once slowly to indicate the controller is in 'Setup' mode.

2. When in 'Setup' mode, both outlet 'Start/Stop' buttons LEDs flash slowly to indicate flow is set to LOW FLOW mode. Quickly flashing LEDs indicate flow is set to HIGH FLOW mode.
3. Press the relevant 'Start/Stop' button to change flow on each outlet as required.
HIGH FLOW mode - quick flashing LEDs
LOW FLOW mode - slow flashing LEDs
4. To save the desired settings and to exit 'Setup' mode, press and hold both 'Start/Stop' buttons together for 5 seconds until both LEDs remain on steady, without flashing. The LEDs will turn off as soon as the 'Start/Stop' buttons are released indicating all settings have been saved and 'Setup' mode has been exited.



Wired remote user guide

1. Press the wired remote button to turn the shower on.
2. The Quartz™ system will operate as determined by the outlet selected during the 'Wired remote setup' procedure.
3. If required, push and hold the button for 2 seconds to stop the 1st outlet and start the 2nd outlet.
4. The flashing-to-steady blue LED display advises when the temperature selected by the main controller has been reached.
5. Turn the shower off either by pressing the main controller or wired remote button.



Cleaning and maintenance

Your shower system should be cleaned using only a soft cloth and washing up liquid.

DO NOT USE ABRASIVE CLEANERS

To reduce the need for chemical descaling in hard water areas, your shower head incorporates a 'clear flow' system, whereby any scale build up can be broken down by gently rubbing the flexible tips of the jets during use. This procedure should be completed regularly, as often as once a week in some hard water areas, as scale build up can affect the spray pattern and cause the shower to perform poorly. Failure to descale the shower head can affect the internal seals and may affect the warranty.

Cleaning and maintenance should not be undertaken by children without supervision by a person responsible for their safety.

Should chemical descaling of the head become necessary, remove the shower head fully and immerse in a mild proprietary descalent.



It is imperative that descaling is carried out in accordance with the manufacturer's instructions, substances that are not suitable for plastics and electroplated surfaces must not be used.

Commissioning - Quartz™ and Rise™

The main controller will automatically assign the outlets as follows:

- Top button to outlet A of the diverter
- Bottom button to outlet B of the diverter

If using a wired remote, by default the remote button will assign outlet A as the primary. If required, this can be changed from outlet A to outlet B, meaning when operated via a wired remote, the preferred outlet will always operate first.

With the Quartz Smart Valve™ mode set to “Normal”, the default flow rate for both outlets is LOW FLOW. However, if required, either or both outlets can be set to HIGH FLOW by following the ‘Setting flow rate’ procedure.

Wired remote setup

Setting the default outlet for remote operation

1. The diverter switch can be accessed by unscrewing the captive fixing screw and removing the lid of the diverter.
2. With the power supply turned off to the Quartz Smart Valve™ use the diverter switch to choose your primary outlet.
Switch position 1 - Outlet A - controller top button
Switch position 2 - Outlet B - controller bottom button
3. Replace the lid onto the diverter and secure using the captive fixing screw.
4. Turn the power supply to the Quartz Smart Valve™ back on.



Changing the default outlet as above will not change which outlet flows when the top or bottom buttons are pressed on the main controller.



The Rise™ product has a number of additional functions available. Please note these features are disabled as a factory default. To activate and programme these features please refer to the Rise User Guide for commissioning and user instructions on how to operate the shower.



Scan here
for diverter
installation video

AQUALISA

Aqualisa Products Limited
The Flyers Way
Westerham Kent TN16 1DE
Customer Helpline: 01959 560010
Brochure Hotline: 0800 652 3669
Website: www.aqualisa.co.uk
Email: enquiries@aqualisa.co.uk
Republic of Ireland
Sales enquiries: 01-864-3363
Service enquiries: 01-844-3212



Please note that calls may be recorded for training and quality purposes.

The company reserves the right to alter, change or modify the product specifications without prior warning.

™ Trademark of Aqualisa Products Limited.



Intertek



Part No: 704024 Issue 02 Nov 18