

www.avfgroup.com

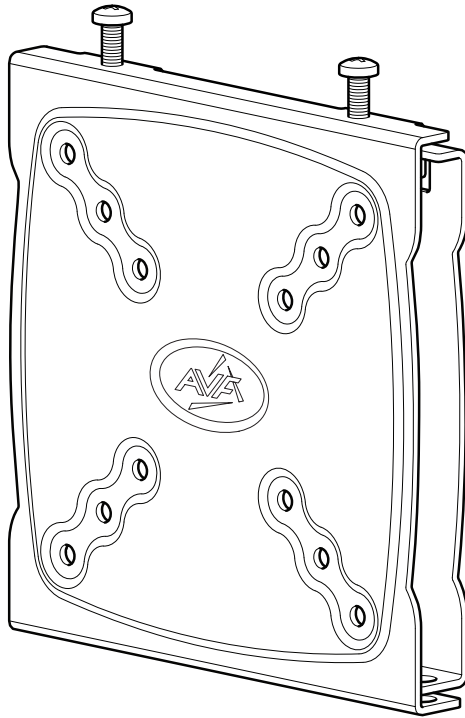

465604 rev01 ###



15kg
33lbs

STOP

Read through ALL instructions before commencing installation.

If you have any questions about this product or issues with installation, contact the customer services help line before returning this product to the store.

**ARRETEZ
-VOUS**

Lisez toutes les instructions avant de débiter l'installation.

Si vous avez des questions sur ce produit ou des problèmes d'installation, contactez l'assistance client avant de ramener le produit en magasin.

ALTO

Lea todas las instrucciones antes de comenzar la instalación.

Si tiene alguna pregunta sobre el producto o problemas con la instalación, llame a la línea de servicio al consumidor antes de devolverlo.

CUSTOMER SERVICES HELP LINE NUMBER:

NUMÉRO DE L'ASSISTANCE CLIENT:

NUMERO DE SERVICIO DE ATENCION AL CLIENTE:

+44 (0)1952 670009 (UK)

1-800 667 0808 (USA)

Assembly Overview
Vue d'ensemble de l'assemblage
Ensambladura General

Fit the TV Mounting Plate
Installer la plaque de montage
du téléviseur
Fije La Placa De Montaje De TV

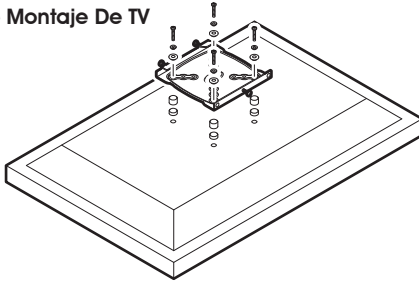

Fit the Wall Bracket
Fixer l'applique murale
Fije el Soporte de Pared

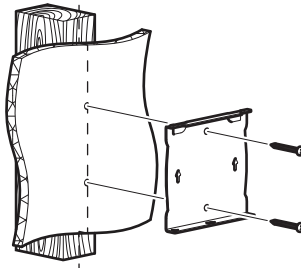

Connect the TV
Connecter le téléviseur
Conecte la TV

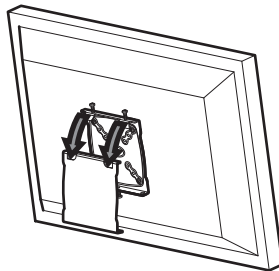

Suitable Wall Types
Types de murs appropriés
Tipos adecuados de pared

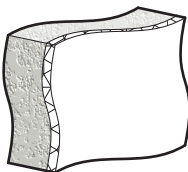

Solid Wall
Mur solide
Pared sólida

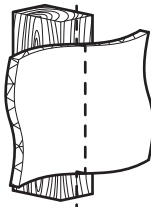

Wood Stud
Latte de bois
Viga de madera

Tools Recommended
Outils recommandés
Herramientas recomendadas

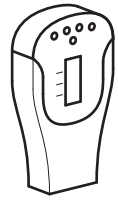

Stud Finder
Trouve latte
Detector de vigas de madera



Ø8mm (5/16")
Masonry
Maçonnerie
Masoneria

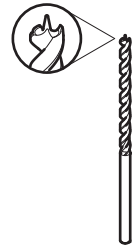

Ø3mm (1/8")
Wood
Bois
Madera

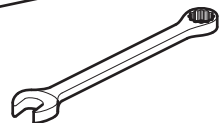
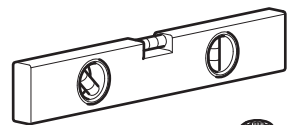
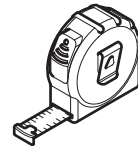
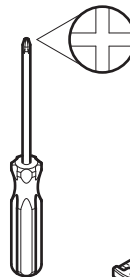
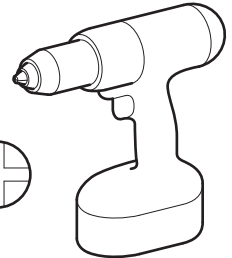

1 Measure the TV fixing holes Width and Height
Mesurer la profondeur et la taille des trous de fixation
Mida los orificios de su TV, lo ancho y lo alto

2 Preparing the TV Mounting Plate
Préparation de la plaque de montage du téléviseur
Preparando La Placa De Montaje De TV

3 Fitting the TV Mounting Plate
Installation de la plaque de montage du téléviseur
Fijando La Placa De Montaje De TV

4 Fitting the Wall Bracket
Installer l'applique murale
Fijando la Placa a la Pared

5 Connecting the TV
Connecter le téléviseur
Conectando la TV

Retain all packaging in case the bracket needs to be returned.

Contents may vary from photography/ Illustrations.

You will not need all these parts, so expect there to be some left over depending upon the specification of your TV.

This product is intended for indoor use only. Use of this product outdoors could lead to failure and personal injury.

It is the responsibility of the installer to ensure that the mounting wall is of a suitable standard and void of any services (eg gas, electricity, water etc).

AVF accept no responsibility for any damage or loss caused by installing this product in a sub standard wall.

Conserver les emballages si l'applique a besoin d'être ramenée.

Les contenus peuvent varier de la photographie/illustrations.

Vous n'aurez pas besoin de toutes ces pièces, attendez-vous donc à ce qu'il reste des pièces selon les caractéristiques de votre téléviseur.

Ce produit est à utiliser à l'intérieur uniquement. Utiliser ce produit à l'extérieur causera des défaillances et de possibles accidents.

Il est de la responsabilité de l'installateur de s'assurer que les murs soient aux critères requis et vides de tout câblage (ex : gaz, électricité, eau etc...)

AVF n'acceptera aucune responsabilité pour tout dommage ou perte causée par l'installation du produit dans un mur en deçà de ces critères.

Conserve todos los envasados en caso de que el soporte tenga que ser devuelto.

El contenido puede variar de la fotografía / ilustración.

No necesitará todas estas partes, espere que sobren algunas según las especificaciones de su TV.

Este producto está diseñado para el uso en el interior solamente. El uso de este producto en el exterior podría llevar al fracaso y lesiones personales.

Es la responsabilidad del instalador de asegurarse de que la pared de montaje es de un nivel adecuado y carece de todo los servicios (gas, electricidad, agua, etc.).

AVF no acepta ninguna responsabilidad por cualquier daño o pérdida causada por la instalación de este producto en una pared inadecuada.

Boxed Parts
 Pièces empaquetées
 Piezas en la Caja

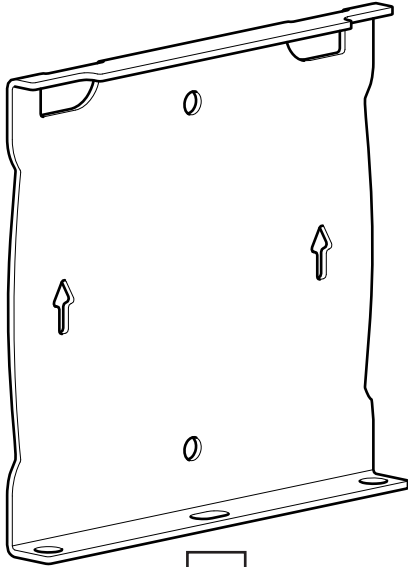

A

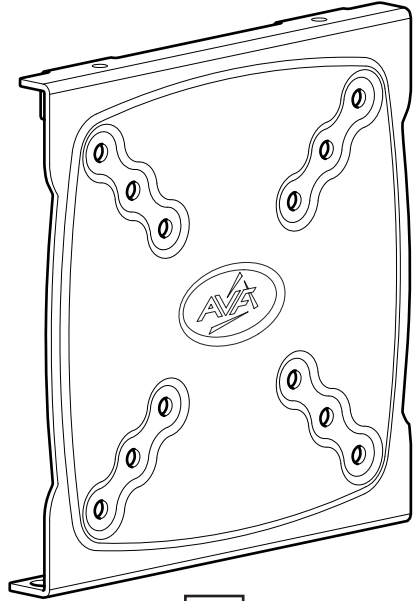

B

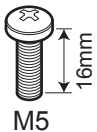

M5

C x3

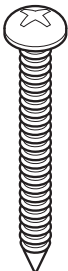

F x2



G x2

TV Screws, Reducers and Spacers
 Vis TV, réducteurs et séparateurs
 Tornillos, Reductores y Espaciadores para TV



D1 x4

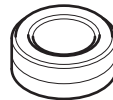

D2 x4

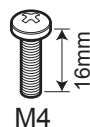

M4

E1 x4

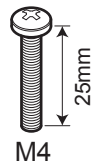

M4

E2 x4

1

Measure the TV fixing holes Width and Height
 Mesurer la profondeur et la taille des trous de fixation
 Mida los orificios de su TV, lo ancho y lo alto

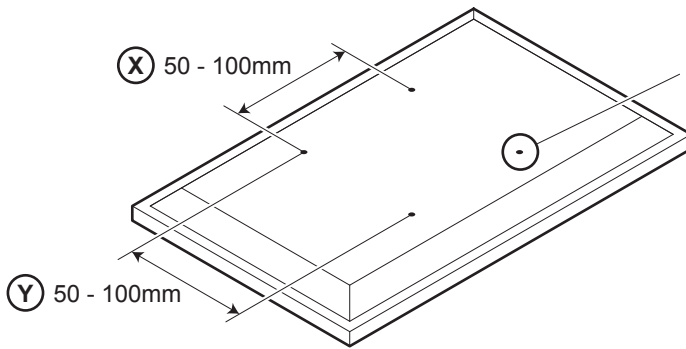

TV Fixing Holes
 Trous de fixation TV
 Orificios de su TV
 para Fijar el Soporte



If width **X** is greater than 100mm or height **Y** greater than 100mm
 STOP installation now and contact the customer help line

Si la largeur **X** est plus large que 100mm et la hauteur **Y** plus grande que 100mm,
 ARRÊTEZ l'installation immédiatement et contactez l'assistance client

Si la anchura **X** es mayor que 100mm o la altura de **Y** es mayor que 100mm
 DETENGA la instalación inmediatamente y póngase en contacto con la línea de
 ayuda al cliente

2

Preparing the TV Mounting Plate
 Préparation de la plaque de montage du téléviseur
 Preparando La Placa De Montaje De TV

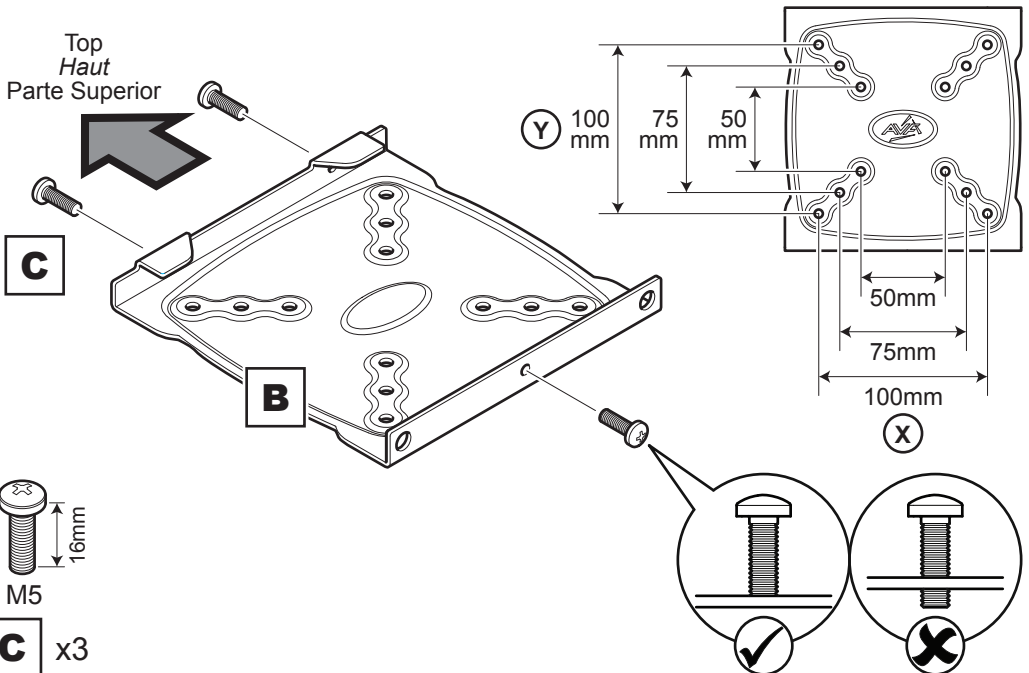

3

Fitting the TV Mounting Plate
Installation de la plaque de montage du téléviseur
Fijando La Placa De Montaje De TV

No Spacers
Pas de séparateur
Sin espaciadores

For TVs with flat / unobstructed back
Pour des téléviseurs aux dos plats et non obstrués
 Para TVs con la parte posterior plana / sin obstáculos

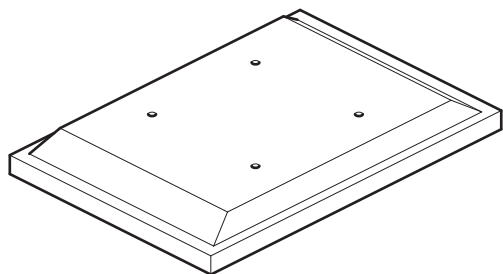

Spacers
Séparateurs
Espaciadores

D1/D2

For TVs with irregular / obstructed back
Pour des téléviseurs aux dos irréguliers et non obstrués
 Para TVs con la parte posterior irregular / con obstáculos

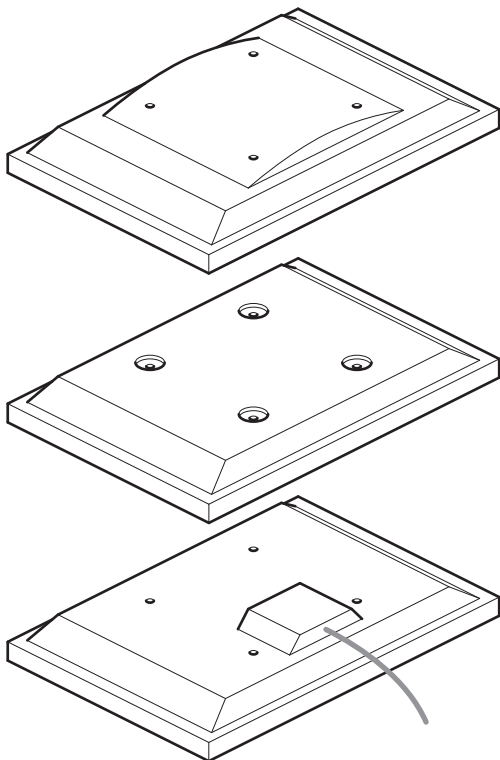

WARNING / AVERTISSEMENT / ADVERTENCIA

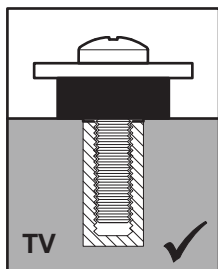
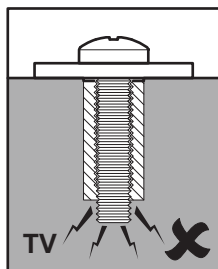
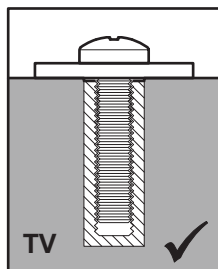
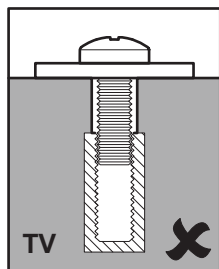

After completing step 3 you will have fittings left over, please keep for future reference.
Après avoir complété l'étape 3 il vous restera des pièces d'assemblage, conservez-les.
 Después de completar el paso 3 usted tendrá conexiones sobrantes, por favor guarde para futura referencia.

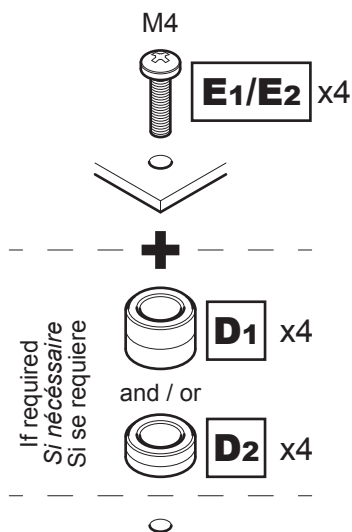
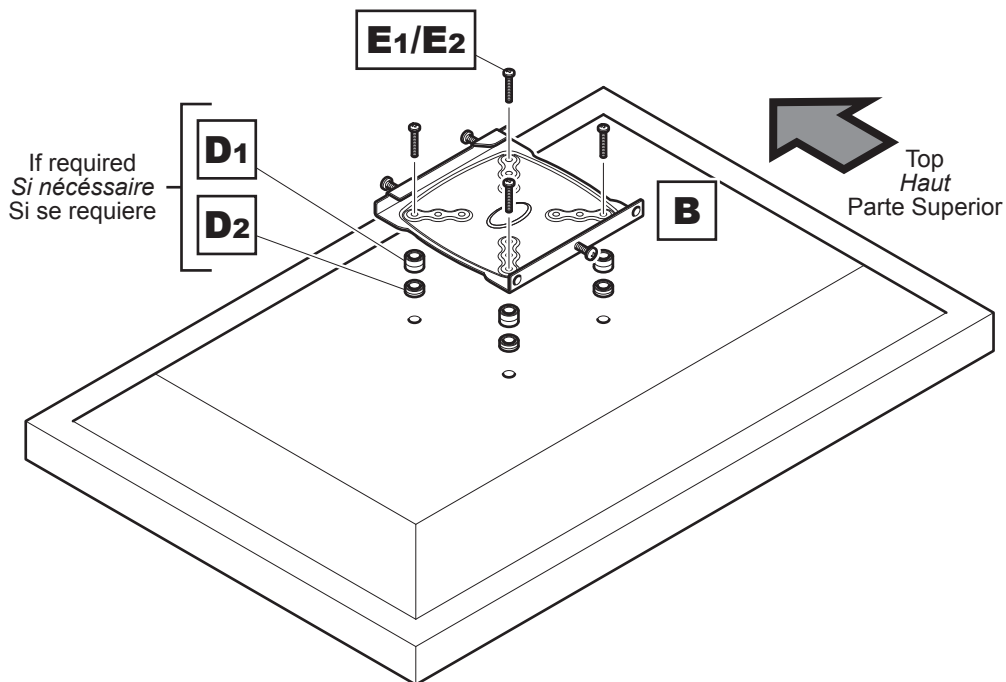

Attach the bracket to the back of your TV using suitable screw and spacer combinations.
Attachez l'applique au dos de votre téléviseur en utilisant une combinaison de vis et de joints adaptés.

Coloque los soportes a la parte posterior de su TV usando la combinación adecuada de tornillo, y espaciador.

Solid Wall / Mur solide / Pared sólida

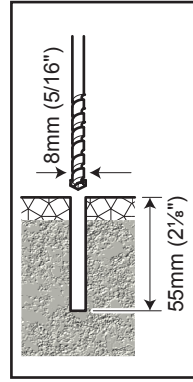
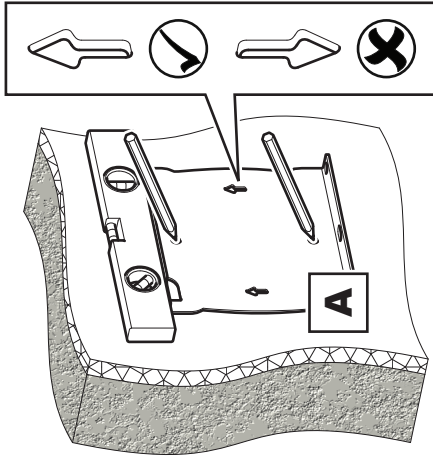

Remove Dust from Hole
 Retirez la poussière du trou
 Elimine el polvo del agujero



Wood Stud / Latte de bois / Viga de madera

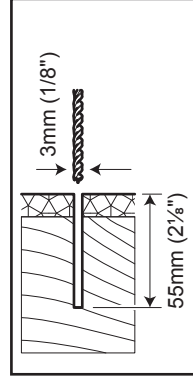
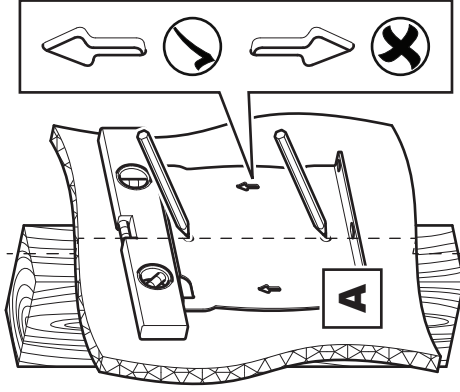
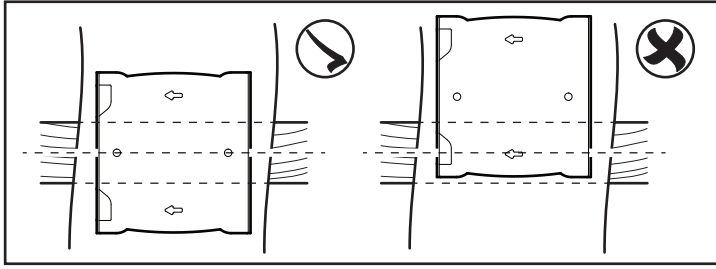

Ensure bracket is in the centre of the wood stud
 Assurez-vous que l'applique est au centre de la latte de bois
 Asegúrese de que el soporte está en el centro de la viga de madera



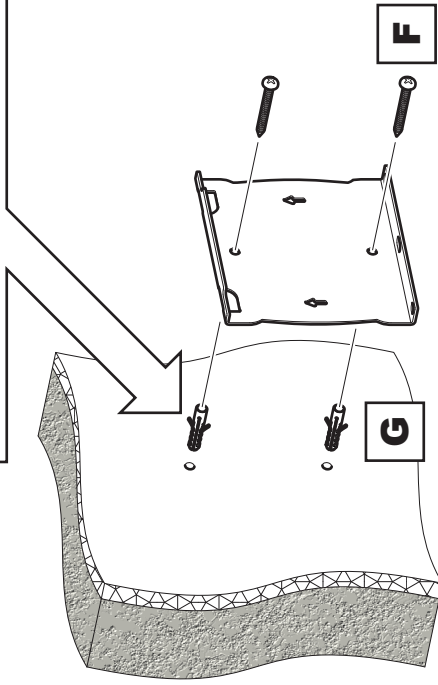
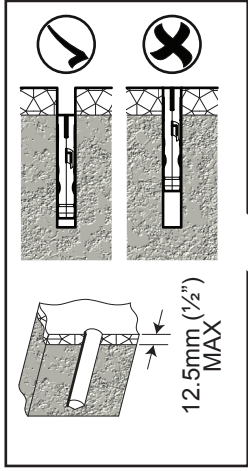

Lubricate screw thread with soap
Lubrifiez le pas de vis avec du savon
 Lubrique la rosca del tornillo con jabón

DO NOT overtighten screws.
 Tighten screws by hand only
Ne serrez pas trop les vis.
Visser à la main seulement
 NO sobre apriete los tornillos.
 Apriete los tornillos sólo a mano

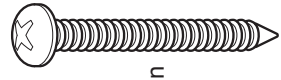

F x2



G x2

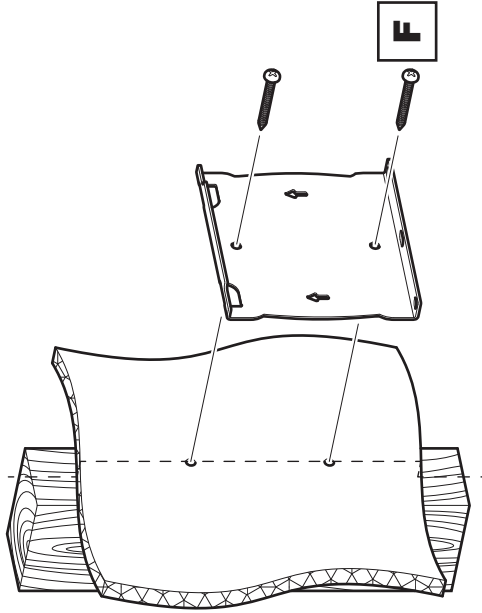

Lubricate screw thread with soap
Lubrifiez le pas de vis avec du savon
 Lubrique la rosca del tornillo con jabón

DO NOT overtighten screws.
 Tighten screws by hand only
Ne serrez pas trop les vis.
Visser à la main seulement
 NO sobre apriete los tornillos.
 Apriete los tornillos sólo a mano

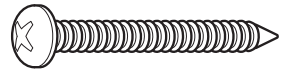

F x2

5

Connecting the TV Connecter le téléviseur Conectando la TV

Attaching and Locking
Fixer et verrouiller
Sujetando y
Asegurando

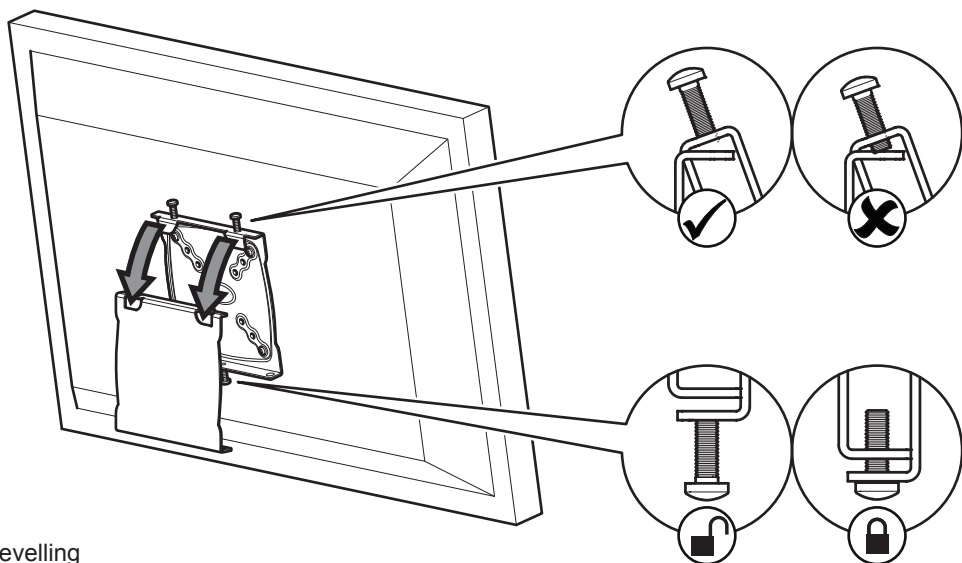

TV Levelling
Mettre au niveau
votre téléviseur
Nivelación de TV

