

INSTRUCTION MANUAL



Cordless Vacuum Cleaner

DVC340

DVC350

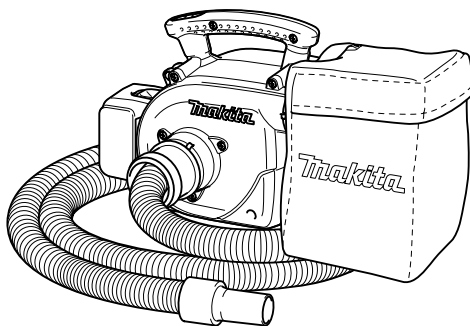

011111

IMPORTANT: Read Before Using.

ENGLISH (Original instructions)

SPECIFICATIONS

Model		DVC340	DVC350		
Capacity	Volume	3.0 L			
	Max. Air volume	3.3 m ³ /min	3.4 m ³ /min		
Continuous use (Approx.)	HIGH	4 min (with BL1415)	6 min (with BL1815)		
		5 min (with BL1415N)	7 min (with BL1815N)		
		-	8 min (with BL1820)		
		10 min (with BL1430)	13 min (with BL1830)		
		13 min (with BL1440)	18 min (with BL1840)		
		-	21 min (with BL1850)		
	LOW	8 min (with BL1415)	12 min (with BL1815)		
		10 min (with BL1415N)	14 min (with BL1815N)		
		-	16 min (with BL1820)		
		20 min (with BL1430)	26 min (with BL1830)		
		26 min (with BL1440)	36 min (with BL1840)		
		-	42 min (with BL1850)		
		Overall length		403 mm	
		Net weight	2.1 kg (BL1415 / BL1415N)	2.2 kg (BL1815 / BL1815N / BL1820)	
2.3 kg (BL1430 / BL1440)	2.4 kg (BL1830 / BL1840 / BL1850)				
Rated voltage		D.C. 14.4 V	D.C. 18 V		

- Due to our continuing program of research and development, the specifications herein are subject to change without notice.
- Specifications and battery cartridge may differ from country to country.
- Weight, with battery cartridge, according to EPTA-Procedure 01/2003

END315-1

ENA006-1

Symbols

The following show the symbols used for the equipment. Be sure that you understand their meaning before use.



• Read instruction manual.



• Only for EU countries

Do not dispose of electric equipment or battery pack together with household waste material!

In observance of the European Directives, on Waste Electric and Electronic Equipment and Batteries and Accumulators and Waste Batteries and Accumulators and their implementation in accordance with national laws, electric equipment and batteries and battery pack(s) that have reached the end of their life must be collected separately and returned to an environmentally compatible recycling facility.

ENE017-1

Intended use

The tool is intended for collecting dry dust.

WARNING: This appliance can be used by children aged from 8 years and above and persons with reduced physical, sensory or mental capabilities or lack of experience and knowledge if they have been given supervision or instruction concerning use of the appliance in a safe way and understand the hazards involved. Children shall not play with the appliance. Cleaning and user maintenance shall not be made by children without supervision.

GEA006-2

General Power Tool Safety

Warnings

⚠ WARNING Read all safety warnings and all instructions. Failure to follow the warnings and instructions may result in electric shock, fire and/or serious injury.

Save all warnings and instructions for future reference.

The term "power tool" in the warnings refers to your mains-operated (corded) power tool or battery-operated (cordless) power tool.

Work area safety

1. **Keep work area clean and well lit.** Cluttered or dark areas invite accidents.

2. **Do not operate power tools in explosive atmospheres, such as in the presence of flammable liquids, gases or dust.** Power tools create sparks which may ignite the dust or fumes.
3. **Keep children and bystanders away while operating a power tool.** Distractions can cause you to lose control.

Electrical safety

4. **Power tool plugs must match the outlet. Never modify the plug in any way. Do not use any adapter plugs with earthed (grounded) power tools.** Unmodified plugs and matching outlets will reduce risk of electric shock.
5. **Avoid body contact with earthed or grounded surfaces such as pipes, radiators, ranges and refrigerators.** There is an increased risk of electric shock if your body is earthed or grounded.
6. **Do not expose power tools to rain or wet conditions.** Water entering a power tool will increase the risk of electric shock.
7. **Do not abuse the cord. Never use the cord for carrying, pulling or unplugging the power tool. Keep cord away from heat, oil, sharp edges or moving parts.** Damaged or entangled cords increase the risk of electric shock.
8. **When operating a power tool outdoors, use an extension cord suitable for outdoor use.** Use of a cord suitable for outdoor use reduces the risk of electric shock.
9. **If operating a power tool in a damp location is unavoidable, use a ground fault circuit interrupter (GFCI) protected supply.** Use of an GFCI reduces the risk of electric shock.

Personal safety

10. **Stay alert, watch what you are doing and use common sense when operating a power tool. Do not use a power tool while you are tired or under the influence of drugs, alcohol or medication.** A moment of inattention while operating power tools may result in serious personal injury.
11. **Use personal protective equipment. Always wear eye protection.** Protective equipment such as dust mask, non-skid safety shoes, hard hat, or hearing protection used for appropriate conditions will reduce personal injuries.
12. **Prevent unintentional starting. Ensure the switch is in the off-position before connecting to power source and/or battery pack, picking up or carrying the tool.** Carrying power tools with your finger on the switch or energising power tools that have the switch on invites accidents.
13. **Remove any adjusting key or wrench before turning the power tool on.** A wrench or a key left attached to a rotating part of the power tool may result in personal injury.

14. **Do not overreach. Keep proper footing and balance at all times.** This enables better control of the power tool in unexpected situations.
15. **Dress properly. Do not wear loose clothing or jewellery. Keep your hair, clothing, and gloves away from moving parts.** Loose clothes, jewellery or long hair can be caught in moving parts.
16. **If devices are provided for the connection of dust extraction and collection facilities, ensure these are connected and properly used.** Use of dust collection can reduce dust-related hazards.

Power tool use and care

17. **Do not force the power tool. Use the correct power tool for your application.** The correct power tool will do the job better and safer at the rate for which it was designed.
18. **Do not use the power tool if the switch does not turn it on and off.** Any power tool that cannot be controlled with the switch is dangerous and must be repaired.
19. **Disconnect the plug from the power source and/or the battery pack from the power tool before making any adjustments, changing accessories, or storing power tools.** Such preventive safety measures reduce the risk of starting the power tool accidentally.
20. **Store idle power tools out of the reach of children and do not allow persons unfamiliar with the power tool or these instructions to operate the power tool.** Power tools are dangerous in the hands of untrained users.
21. **Maintain power tools. Check for misalignment or binding of moving parts, breakage of parts and any other condition that may affect the power tool's operation. If damaged, have the power tool repaired before use.** Many accidents are caused by poorly maintained power tools.
22. **Keep cutting tools sharp and clean.** Properly maintained cutting tools with sharp cutting edges are less likely to bind and are easier to control.
23. **Use the power tool, accessories and tool bits etc. in accordance with these instructions, taking into account the working conditions and the work to be performed.** Use of the power tool for operations different from those intended could result in a hazardous situation.

Battery tool use and care

24. **Recharge only with the charger specified by the manufacturer.** A charger that is suitable for one type of battery pack may create a risk of fire when used with another battery pack.
25. **Use power tools only with specifically designated battery packs.** Use of any other battery packs may create a risk of injury and fire.

26. **When battery pack is not in use, keep it away from other metal objects, like paper clips, coins, keys, nails, screws or other small metal objects, that can make a connection from one terminal to another.** Shorting the battery terminals together may cause burns or a fire.
 27. **Under abusive conditions, liquid may be ejected from the battery; avoid contact. If contact accidentally occurs, flush with water. If liquid contacts eyes, additionally seek medical help.** Liquid ejected from the battery may cause irritation or burns.
- Service**
28. **Have your power tool serviced by a qualified repair person using only identical replacement parts.** This will ensure that the safety of the power tool is maintained.
 29. **Follow instruction for lubricating and changing accessories.**
 30. **Keep handles dry, clean and free from oil and grease.**

ENB117-4

CORDLESS VACUUM CLEANER SAFETY WARNINGS

⚠ WARNING! IMPORTANT READ CAREFULLY all safety warnings and all instructions BEFORE USE . Failure to follow the warnings and instructions may result in electric shock, fire and/or serious injury.

1. **Operators must be adequately instructed on the use of this cleaner.**
2. **This cleaner is not suitable for picking up hazardous dust.**
3. **This cleaner is for dry use only.**
4. **This cleaner is for indoor use only.**
5. **This cleaner shall be stored indoors only.**
6. **Do not pick up the following materials:**
 - **Hot materials such as lit cigarettes or spark/metal dust generated by grinding/cutting metal**
 - **Flammable materials such as gasoline, thinner, benzine, kerosene or paint**
 - **Explosive materials like nitroglycerin**
 - **Ignitable materials such as Aluminum, zinc, magnesium, titanium, phosphorus or celluloid**
 - **Wet dirt, water, oil or the like**
 - **Hard pieces with sharp edges, such as wood chips, metals, stones, glasses, nails, pins or razors**
 - **Powder to clot such as cement or toner**
 - **Conductive dust such as metal or carbon**
 - **Fine particle like concrete dust**

Such action may cause fire, injury and/or property damage.

7. **Stop operation immediately if you notice anything abnormal.**
8. **Do not bring close to stoves or other heat sources.**
9. **Do not block the intake hole or vent holes.**
10. **Do not leave the cleaner when battery fitted. Remove battery from appliance when not in use and before servicing.**
11. **Do not allow to be used as a toy. Close attention is necessary when used by or near children.**
12. **Use only as described in this manual. Use only manufacturer's recommended attachments.**
13. **Do not put any object into openings. Do not use with any opening blocked; keep free of dust, lint, hair, and anything that may reduce air flow.**
14. **Use extra care when cleaning on stairs.**
15. **When using the cleaner as a blower**
 - **always use protective goggles, a cap and mask while operating;**
 - **always be sure that the cleaner is switched off and the battery cartridge is removed before clearing a blockage;**
 - **always be sure of your footing on slopes;**
 - **walk, never run;**
 - **never point the nozzle at anyone in the vicinity;**
 - **Keep all nuts, bolts and screws tight to be sure the cleaner is in safe working condition;**
 - **Store the cleaner only in a dry place;**
 - **The operator or user is responsible for accidents or hazards occurring to other people or their property.**

KEEP FOR FUTURE REFERENCE

⚠ WARNING:

DO NOT let comfort or familiarity with product (gained from repeated use) replace strict adherence to safety rules for the subject product. MISUSE or failure to follow the safety rules stated in this instruction manual may cause serious personal injury.

This cleaner is intended for both domestic and commercial use, for example in hotels, schools, hospitals, factories, shops, offices and rental businesses.

IMPORTANT SAFETY INSTRUCTIONS

FOR BATTERY CARTRIDGE

- Before using battery cartridge, read all instructions and cautionary markings on (1) battery charger, (2) battery, and (3) product using battery.
- Do not disassemble battery cartridge.
- If operating time has become excessively shorter, stop operating immediately. It may result in a risk of overheating, possible burns and even an explosion.
- If electrolyte gets into your eyes, rinse them out with clear water and seek medical attention right away. It may result in loss of your eyesight.
- Do not short the battery cartridge:
 - Do not touch the terminals with any conductive material.
 - Avoid storing battery cartridge in a container with other metal objects such as nails, coins, etc.
 - Do not expose battery cartridge to water or rain.

A battery short can cause a large current flow, overheating, possible burns and even a breakdown.
- Do not store the tool and battery cartridge in locations where the temperature may reach or exceed 50 ° C (122 ° F).
- Do not incinerate the battery cartridge even if it is severely damaged or is completely worn out. The battery cartridge can explode in a fire.
- Be careful not to drop or strike battery.
- Do not use a damaged battery.
- Follow your local regulations relating to disposal of battery.

SAVE THESE INSTRUCTIONS.

Tips for maintaining maximum battery life

- Charge the battery cartridge before completely discharged.
Always stop tool operation and charge the battery cartridge when you notice less tool power.
- Never recharge a fully charged battery cartridge. Overcharging shortens the battery service life.
- Charge the battery cartridge with room temperature at 10 ° C - 40 ° C (50 ° F - 104 ° F). Let a hot battery cartridge cool down before charging it.
- Charge the battery cartridge once in every six months if you do not use it for a long period of time.

FUNCTIONAL DESCRIPTION

⚠CAUTION:

- Always be sure that the cleaner is switched off and the battery cartridge is removed before adjusting or checking function on the cleaner.

Installing or removing battery cartridge

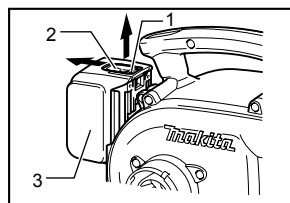

- Red part
- Button
- Battery cartridge

011112

- Always switch off the cleaner before insertion or removal of the battery cartridge.
- To remove the battery cartridge, withdraw it from the cleaner while sliding the button on the front of the cartridge as shown in the figure.
- To insert the battery cartridge, align the tongue on the battery cartridge with the groove in the housing and slip it into place. Always insert it all the way until it locks in place with a little click. If you can see the red part on the upper side of the button, it is not locked completely. Insert it fully until the red part cannot be seen. If not, it may accidentally fall out of the cleaner, causing injury to you or someone around you.
- Do not use force when inserting the battery cartridge. If the cartridge does not slide in easily, it is not being inserted correctly.

Battery protection system

The cleaner is equipped with the protection system, which automatically cuts off the output power for its long service life.

The cleaner stops during operation when the cleaner and/or battery are placed under the following situation. This is caused by the activation of protection system and does not show the cleaner trouble.

- When the cleaner is overloaded:
 - At this time, press the "OFF" button and remove causes of overload and then press the "HIGH/LOW" button again to restart.
- When battery cells get hot: (refer to the note below.)
 - If any operation of the "HIGH/LOW" button and the "OFF" button, the motor will remain stopped. At this time, stop use of the cleaner and cool or charge the battery cartridge after removing it from the cleaner.

- When the remaining battery capacity gets low: If any operation of the "HIGH/LOW" button and the "OFF" button, the motor will remain stopped. At this time, remove the battery cartridge from the cleaner and charge it.

NOTE:

- This temperature-sensitive protection is applied only when the cleaner is used with a battery cartridge with a star mark.

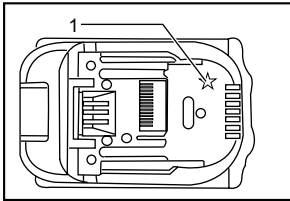

011389

1. Star mark

Switch action

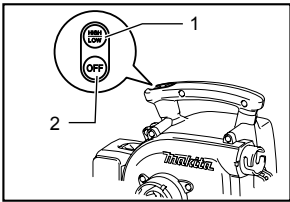

011121

1. HIGH/LOW button
2. OFF button

To start the cleaner, simply press the "HIGH/LOW" button. To switch off, press the "OFF" button. To change the cleaner speed, press the "HIGH/LOW" button. The first press on this button is for high speed and the second press for low speed and then each press on this button repeats the high/low speed cycle alternatively.

ASSEMBLY

⚠CAUTION:

- Always be sure that the cleaner is switched off and the battery cartridge is removed before carrying out any work on the cleaner.
- Any work with the battery cartridge being installed on the cleaner may cause a personal injury or damage to the objects around the cleaner.

Installing dust bag

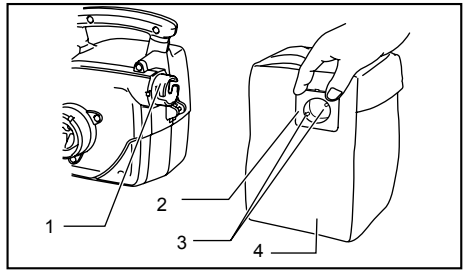

1. Dust outlet
2. Dust bag joint
3. Pins
4. Dust bag

011113

Hold the square section of the dust bag joint and fit the pins inside the dust bag joint to the notches in the dust outlet of the cleaner and then insert and turn it clockwise all the way until it stops.

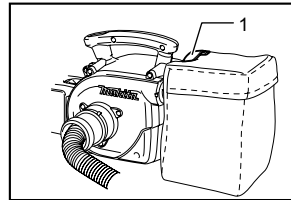

011114

1. Hook

At this time, make sure that the fastener part on the dust bag faces upward.

NOTE:

- When the dust bag joint and the ring inside the dust bag come off, install as follows.
 - Align the dust bag joint with the seam of the dust bag and install it so that its protrusion faces upward.

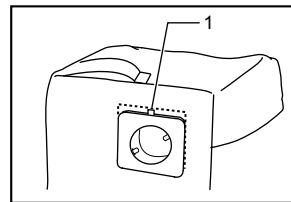

011115

1. Protrusion

- Tighten the ring inside the dust bag firmly so that the pins and the ring are positioned as shown in the figure.

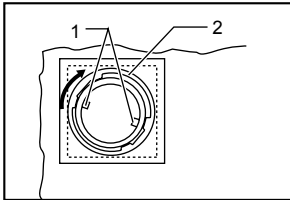

1. Pins
2. Ring

011116

Installing the shoulder strap

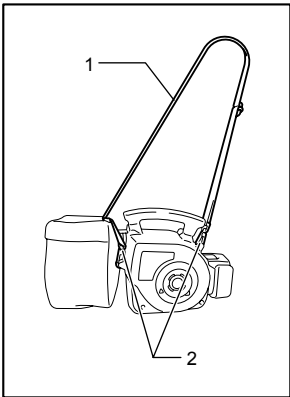

1. Shoulder strap
2. Two hooks

011117

Attach one end hook of the shoulder strap onto the ring in the front of the cleaner and thrust the other end of the strap through the band of the dust bag and then attach the other end hook as shown in the figure.

Adjusting the shoulder strap

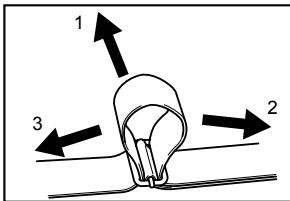

1. Pull out
2. For shortening
3. For extending

011118

To adjust the length of the shoulder strap, pull it out to your desired length and pull the strap in the direction of arrow as shown in the figure.

Connecting the hose

⚠ CAUTION:

- **Do not force the hose to bend it and/or stamp it.** Forcing and/or stamping the hose may cause deformation or damage to the hose.

- **Do not pull the hose to carry the cleaner.** Pulling the hose may cause deformation or damage to the hose.

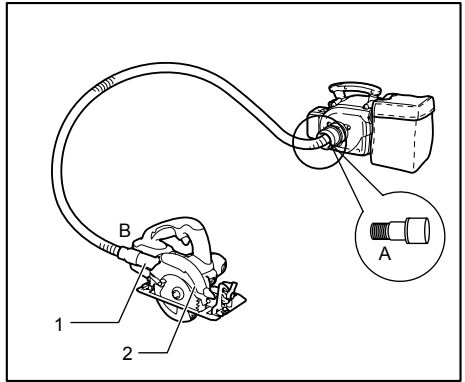

1. Dust outlet
2. Power tool

011119

Insert the "A" end of the hose to the suction opening of the cleaner and turn it clockwise all the way until it locks. Attach the cuff on the "B" end of the hose and then connect it to the dust outlet of a power tool.

Replacing the front cuff

Change the front cuff of the hose according to the dust outlet size of a power tool you use.

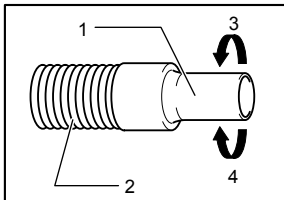

1. Front cuff
2. Hose
3. Remove
4. Install

011120

To remove the front cuff, hold the hose and turn it counterclockwise.

To mount the front cuff, turn it clockwise and then screw it in until it stops.

OPERATION

⚠ WARNING:

- Do not use the shoulder strap when working in a high place.
- When using the cleaner as a stationary cleaner, place it on a flat and stable surface.

Vacuum Cleaner

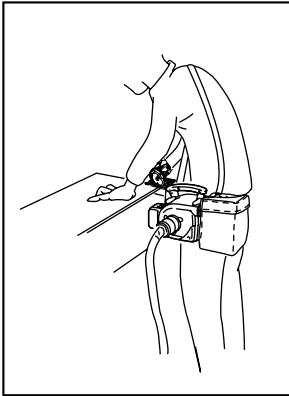

011122

When using the cleaner as a portable cleaner, cross-hanging the shoulder strap before the breast is difficult to drop the cleaner.

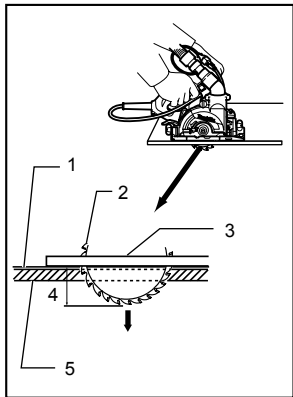

011123

NOTE:

- Long cut-off decorative paper that may be produced by plaster board cutting work depending on the conditions of workpiece to be cut and that may be stuffed inside the hose may cause the hose suction blocking. When this occurs, change the cutting depth setting of power tool to deeper depth, which will relieve the hose suction blocking.

CAUTION:

- When the dust bag is just new, dust may come out of its surface. Using it a few times will minimize the dust leak from the surface.

Operation of the cleaner with a nozzle or a dust bag being installed

WARNING:

- Always be sure that the cleaner is switched off and the battery cartridge is removed before installing or removing the nozzle or any other attachment on the cleaner. Failure to switch off and remove the battery cartridge may result in serious personal injury.

NOTE:

- Before the blower mode operation immediately after the cleaner mode operation, remove all remaining dust from the cleaner due to possible blow out of dust .

Using as a blower

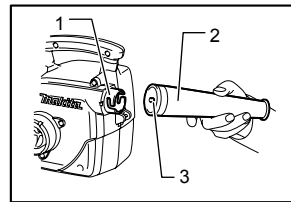

1. Outlet (air vent)
2. Nozzle
3. Pin

011124

Install the nozzle onto the outlet (air vent) without fail. To install the nozzle, fit the pin protruding from the inside of nozzle to one of the cleaner notches and then turn the nozzle clockwise securely.

To remove the nozzle, turn counterclockwise and pull it out.

Direct the top point of the cleaner and then switch on.

Emptying the dust bag

WARNING:

- Always be sure that both the cleaner and a connected power tool are switched off and the battery cartridge is removed and the power tool, if corded tool, is unplugged before installing or removing the dust bag on the cleaner and emptying the dust bag (made of cloth). Failure to switch off, remove the battery cartridge and unplug the connected power tool may result in electric shock and serious personal injury.
- When the dust bag is about half full, remove the dust bag from the cleaner and pull the fastener out. Empty the dust bag of its contents, tapping it lightly so as to remove particles adhering to the insides which might hamper further collection.

NOTE:

- For the time to empty the dust bag, use a guide line that the dust bag becomes full when drilling about 450 holes with 6.5 mm diameter and 40 mm depth on the concrete. A dust bag clogged with the built up particles may reduce the dust collection power and cause damage to the cleaner motor.

CAUTION:

- Attach the dust bag (made of cloth) to the dust bag joint securely and close the fastener completely before use. Failure to attach the dust bag securely and close its fastener completely may cause blow-out of dust and result in serious personal injury.

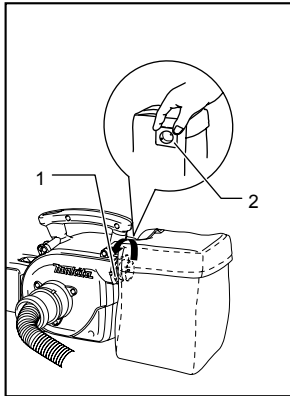

1. Dust bag joint
2. Square section

011125

Pick up the square section of the dust bag joint firmly, turn it counterclockwise and then remove the dust bag.

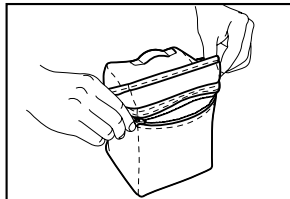

011126

Open the fastener and dispose of the dust.

CAUTION:

- Remove all particles adhering to the fastener area.

MAINTENANCE

WARNING:

- Always be sure that the cleaner is switched off and the battery cartridge is removed before attempting to perform inspection or maintenance.

Cleaning the filter area

CAUTION:

- Do not pick up materials other than dust, such as stone, wood chip and the like since this cleaner is intended for dust collection. Picking up stone, wood chip and the like may cause damage to the fan and the cleaner.

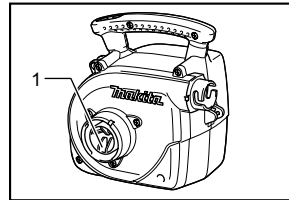

1. Filter area

011127

Check and clean up the filter area in the suction inlet regularly. Remove foreign objects which will obstruct suction.

Cleaning

From time to time wipe off the outside (cleaner body) of the cleaner using a cloth dampened in soapy water.

CAUTION:

- Never use gasoline, benzine, thinner, alcohol or the like. Discoloration, deformation or cracks may result.

To maintain product SAFETY and RELIABILITY, repairs, any other maintenance or adjustment should be performed by Makita Authorized Service Centers, always using Makita replacement parts.

OPTIONAL ACCESSORIES

CAUTION:

- These accessories or attachments are recommended for use with your Makita cleaner specified in this manual. The use of any other accessories or attachments might present a risk of injury to persons. Only use accessory or attachment for its stated purpose.

If you need any assistance for more details regarding these accessories, ask your local Makita Service Center.

- Nozzles
- Dust bags
- Hoses
- Front cuffs
- Shoulder straps
- Makita genuine battery and charger

NOTE:

- Some items in the list may be included in the tool package as standard accessories. They may differ from country to country.

Makita Corporation