

465149 rev00 ##

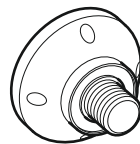
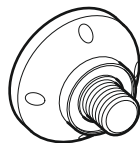
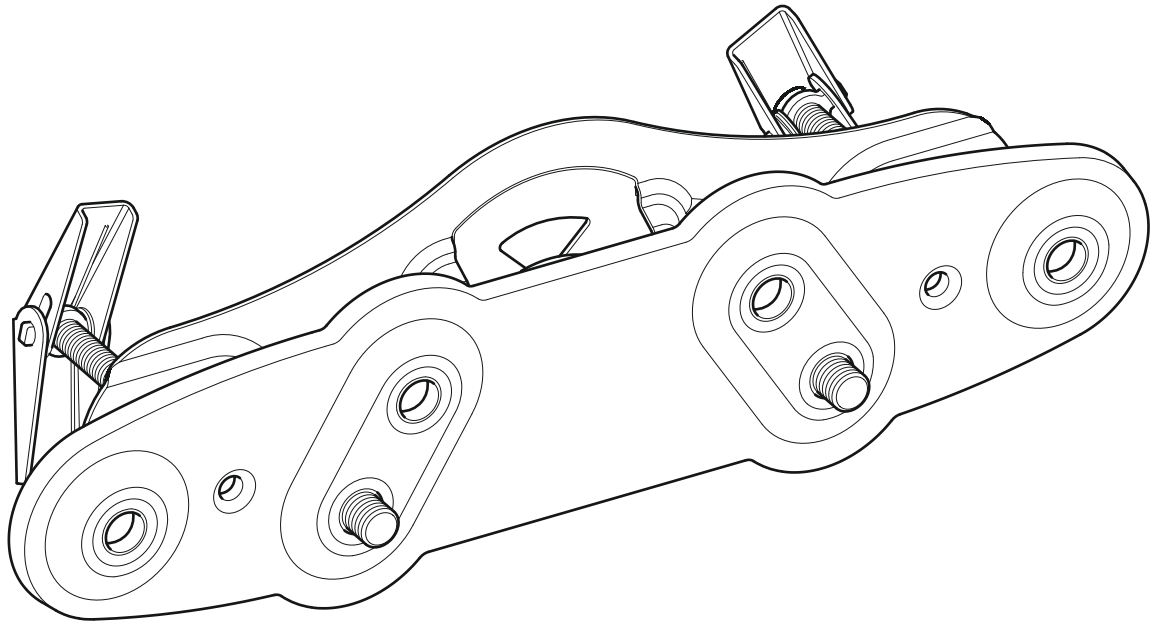

Read through ALL instructions before commencing installation.
If you have any questions about this product or issues with installation contact the customer services help line before returning this product to the store.
See www.avfgroup.com/unimax for instruction video.

CUSTOMER SERVICES HELP LINE NUMBER:

+44 (0)1952 670009 (UK)

1-800 667 0808 (USA)

44lbs
20kg

AVF Group Ltd. Hortonwood 30, Telford, Shropshire, TF1 7YE, England

AVF Incorporated 3187, Cornerstone Drive, Eastvale, CA 91752, USA

www.avfgroup.com

1 Boxed Parts

You will not need all these parts, so expect there to be some left over depending upon the specification of your TV.

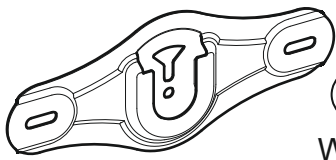

A - x1
Wall Bracket

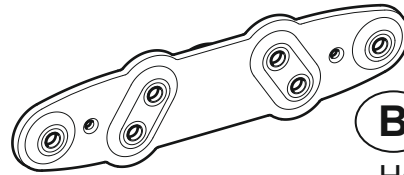

B - x1
Hanger



C - x2
Stand-off

TV Fixings: Parts go on the back of the TV (specification of your TV will determine which ones you require - see section 9).

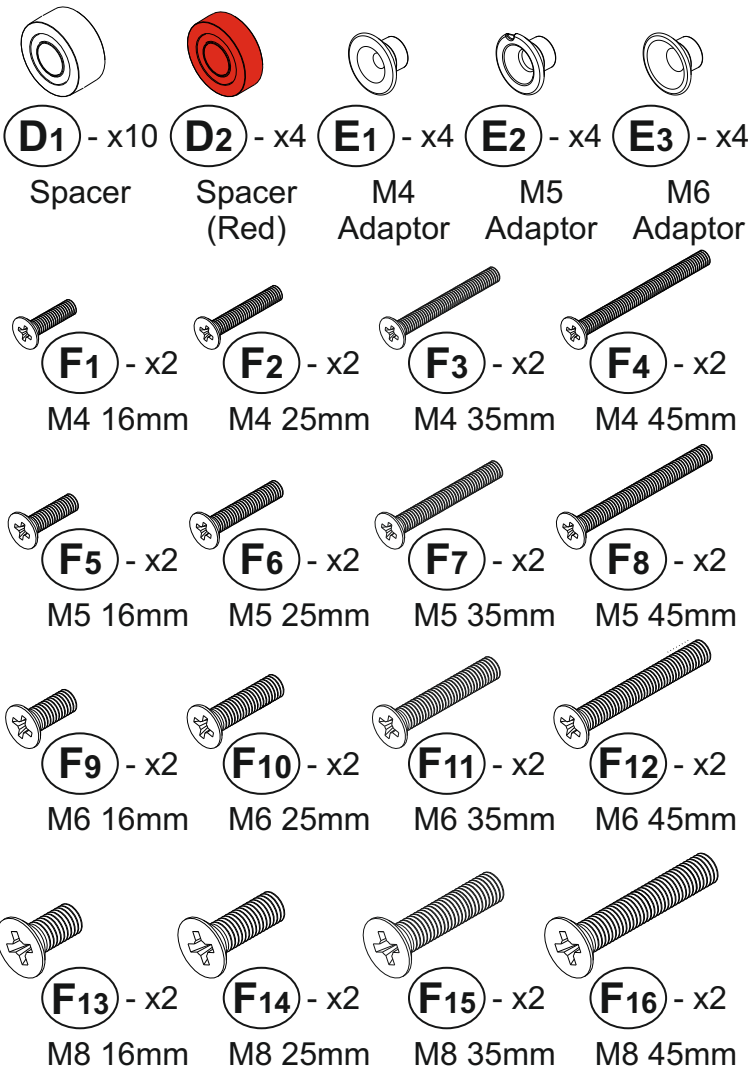

Wall Fixings: Parts to attach to the wall (type of wall will determine which fixings you require).

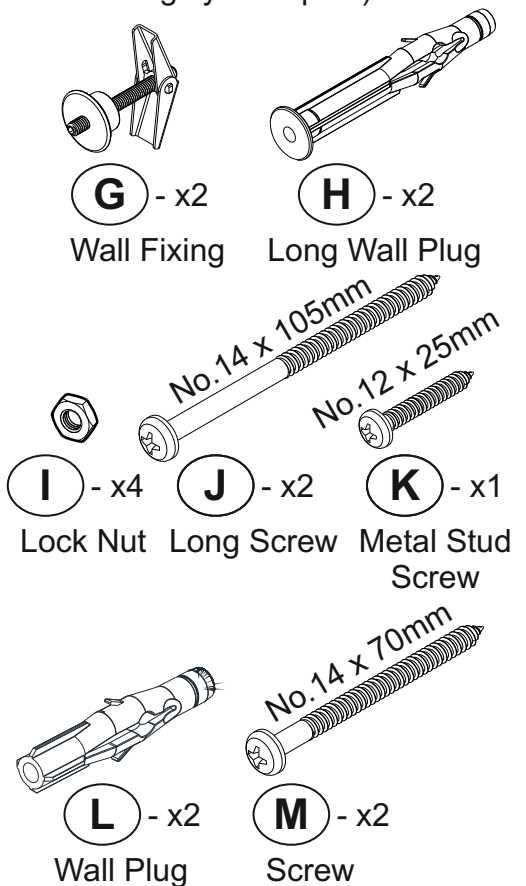

Included Tools

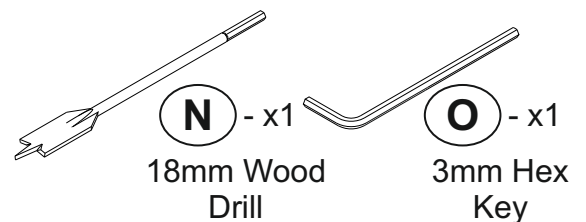

2 Tools Required

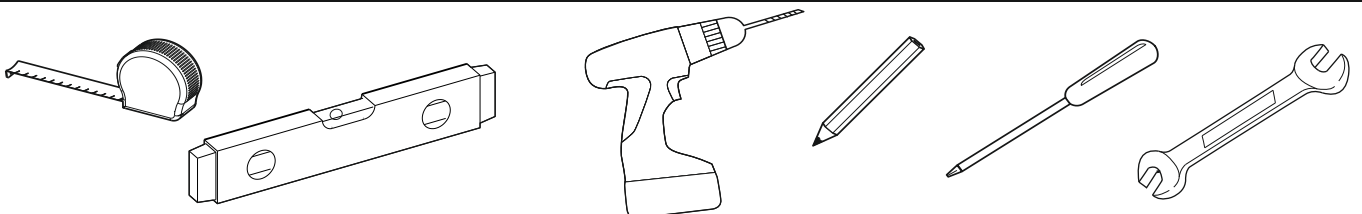

3 Determine Correct TV Screw Size

Choose from the TV Fixings selection. You need to determine which length and diameter of screws fits your TV. To determine the correct screw diameter, try screwing (F₂), (F₆), (F₁₀) & (F₁₄) into one of the fixing holes on the back of the screen until you find the one that fits. Note the thread size and ensure you use the appropriate diameter screws.

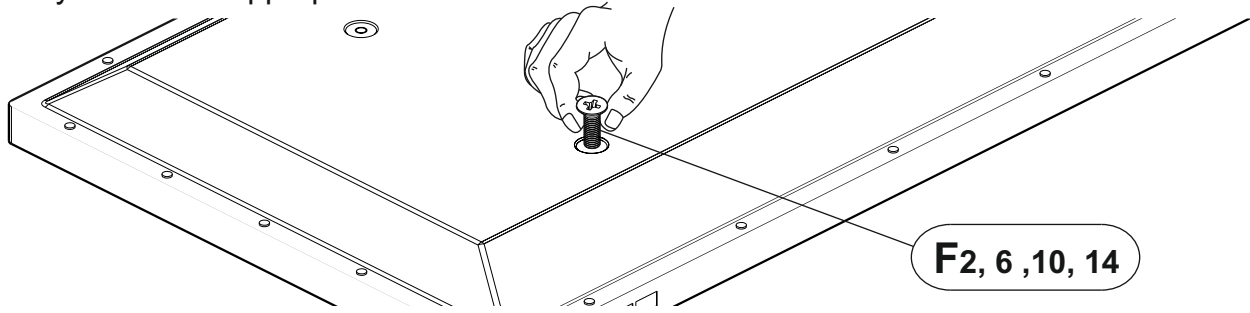

4 Fit Screen Hangers To TV

Once you have established which screws you need for your TV you can attach the Adaptor (B) and Stand-offs (C) to the back of your TV.

Typical recommended examples shown are for fixings with the TV spaced 20mm from the wall. The TV Mount can position your TV between 20mm and 40mm from the wall. For alternative configurations see sections 9.

You might need to use spacers to increase the clearance of your TV from the wall in order to avoid cables coming out of your TV and improve access and ventilation to the back of your TV (spacers (D1) allow you to have a gap of 30mm or 40mm, see section 9).

In certain circumstances it may be necessary to use red spacer (D2) as either a replacement or addition to spacer (D1), for more information please see section 9.

If your TV fixing centres don't fit, STOP installation and contact the customer services helpline.

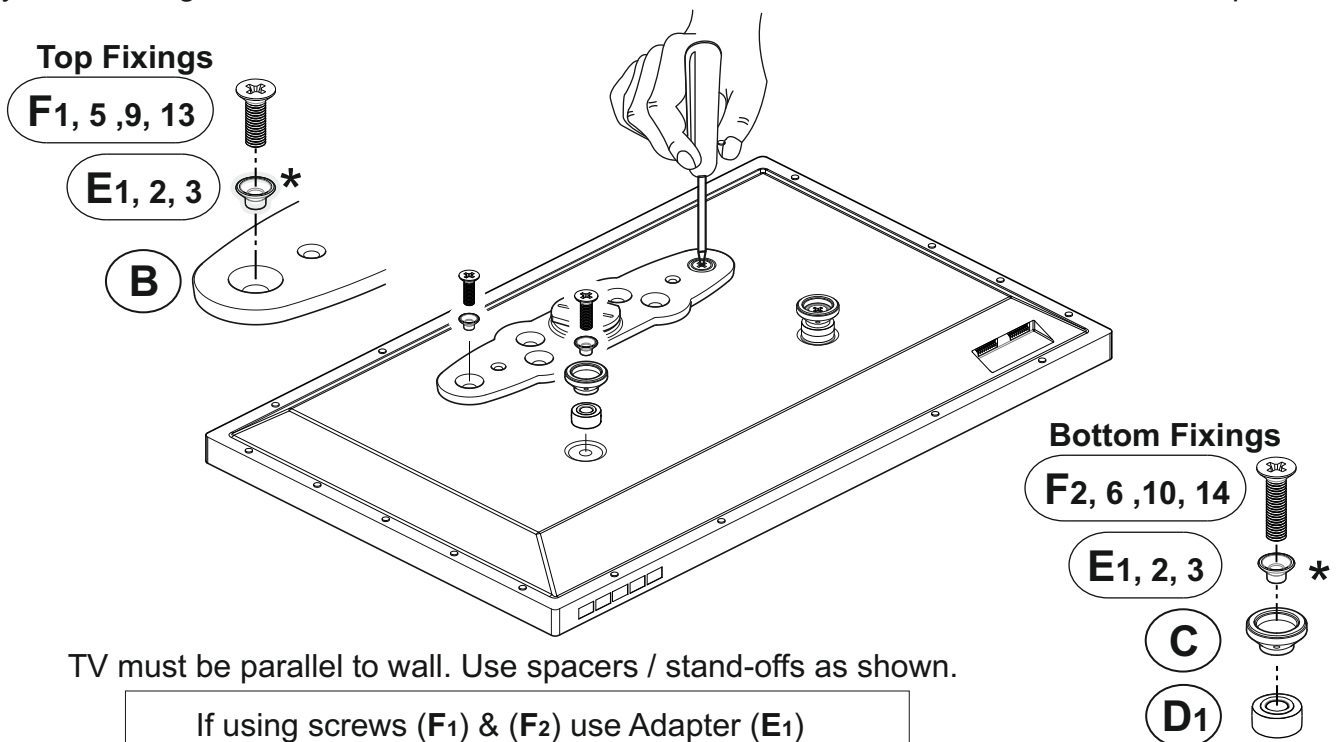

- If using screws (F₁) & (F₂) use Adaptor (E₁)
- If using screws (F₅) & (F₆) use Adaptor (E₂)
- * If using screws (F₉) & (F₁₀) use Adaptor (E₃)
- If using screws (F₁₃) & (F₁₄) no Adaptor required

5 Marking Wall For Drill Points

Decide the position of your wall bracket and using a pencil lightly draw a straight, level line approx 220mm long.

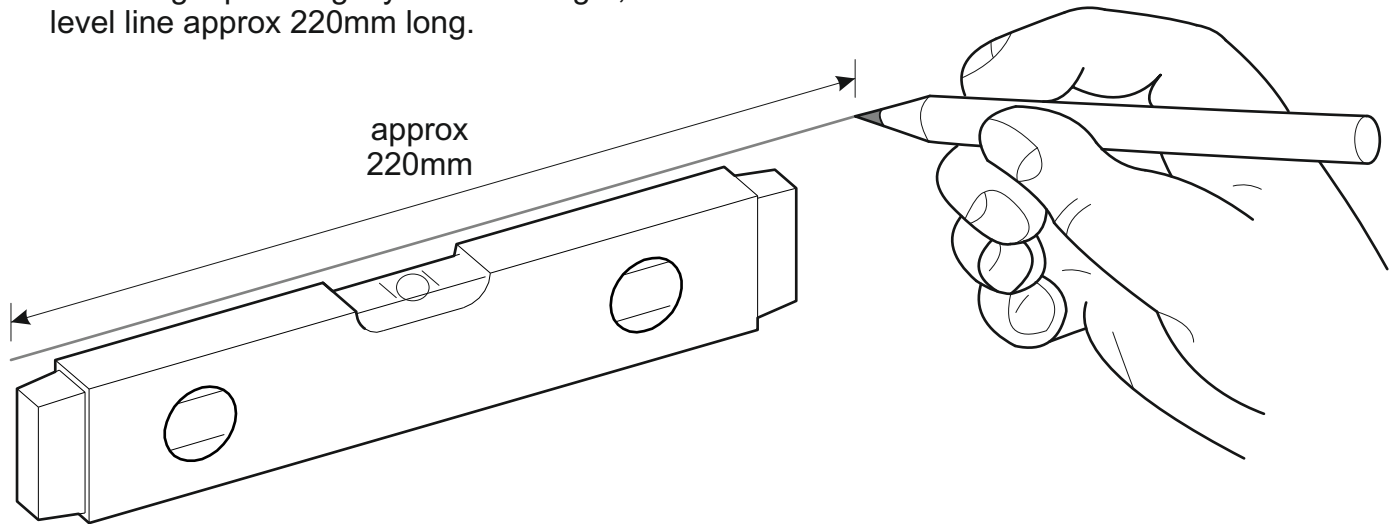

Use the Wall Bracket (A) as a template and position it on your wall. Ensure the bracket lines up with the line you have previously drawn and mark the two DRILL POINTS with a pencil.

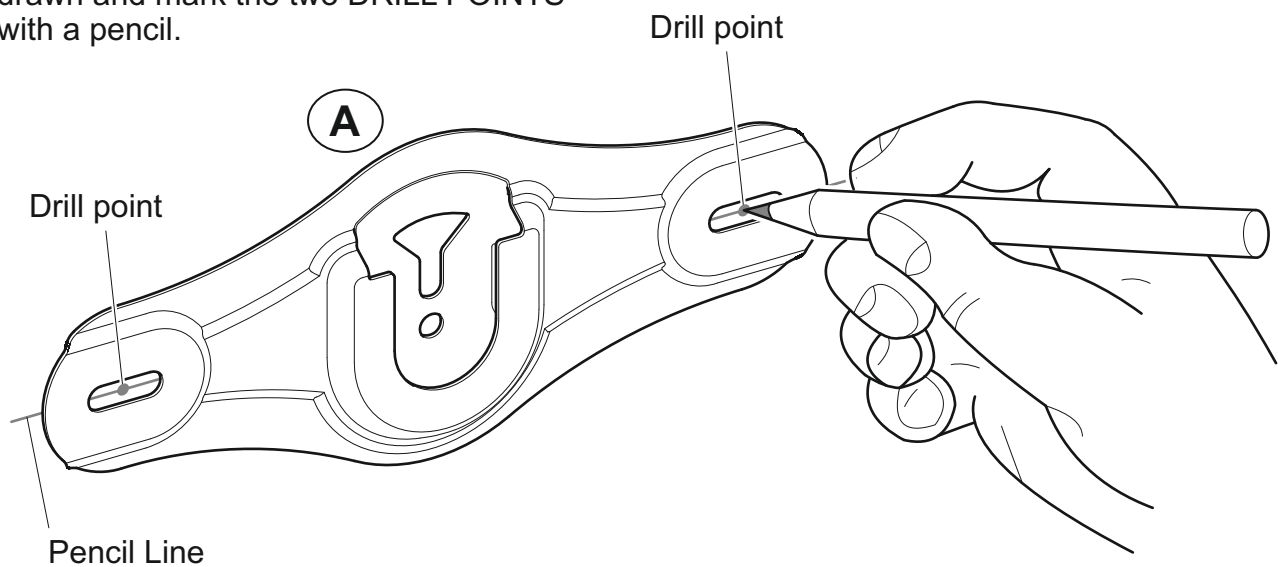

6 Planning & Preparation

Determine the wall type that you have (i.e. Brick/Stud/Plasterboard/Sheetrock).
Ensure the drilling area is free from mains services (Gas/Electric/Water).
Drill three 3mm diameter pilot holes to verify the wall type and select the appropriate fixings (See Section 7).

7 Install Wall Fixings

Use the correct fixings for your wall type. Mixing fixing types may be required for installations that span different wall types. **DO NOT OVER TIGHTEN SCREWS.**

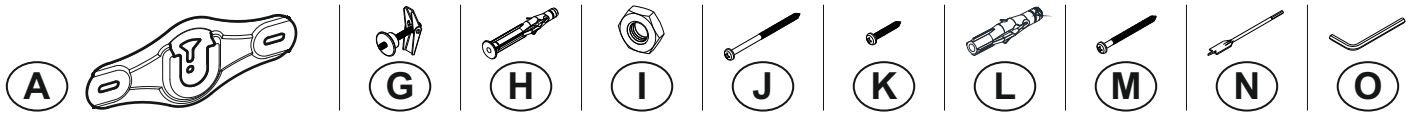

Solid Wall

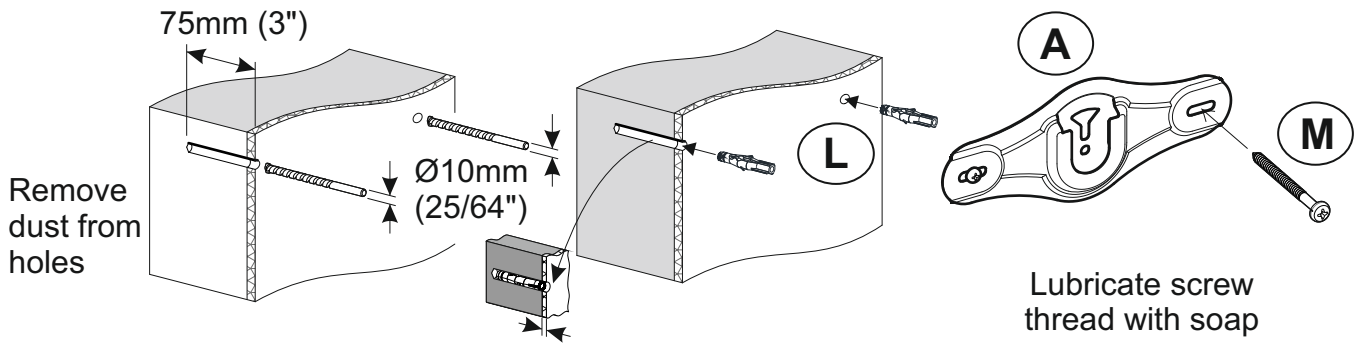

Dot & Dab

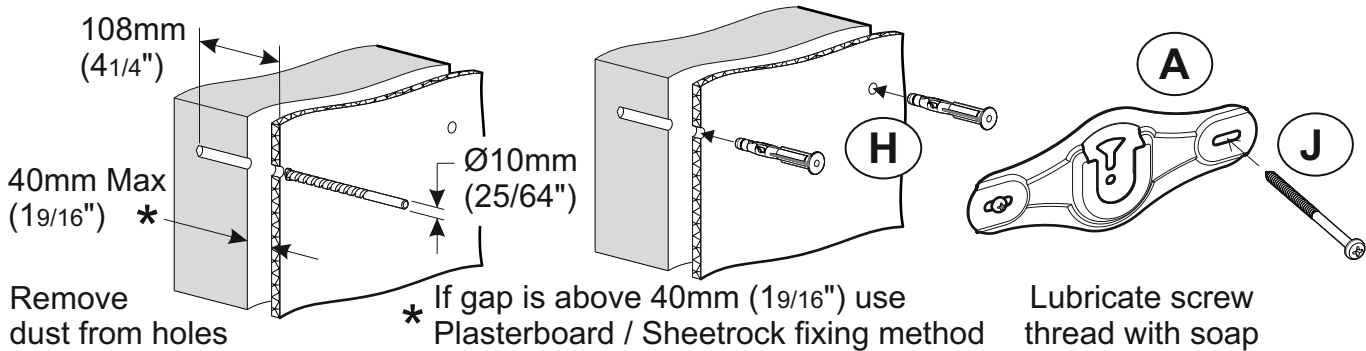

Plasterboard / Sheetrock

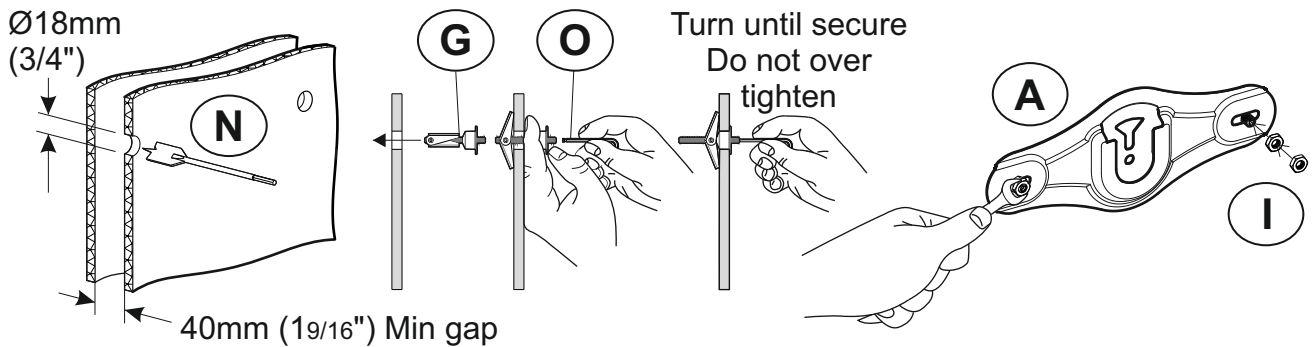

Wood Stud

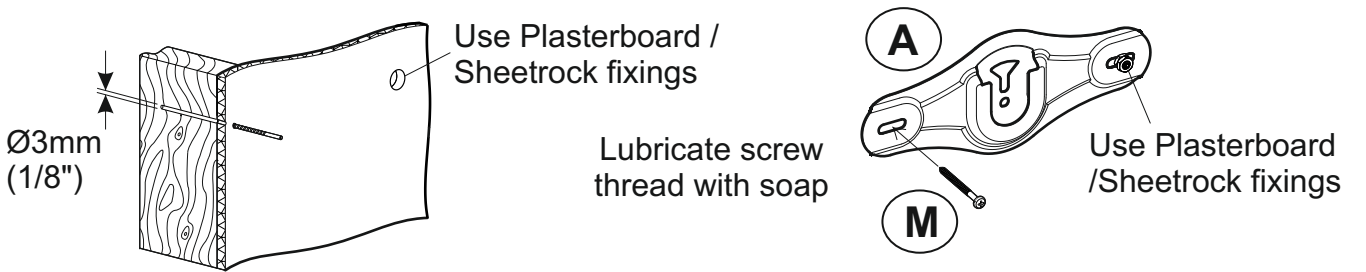

Only one fixing will be in the wood stud. The other fixings will be in plasterboard / sheetrock (see above).

Metal Stud

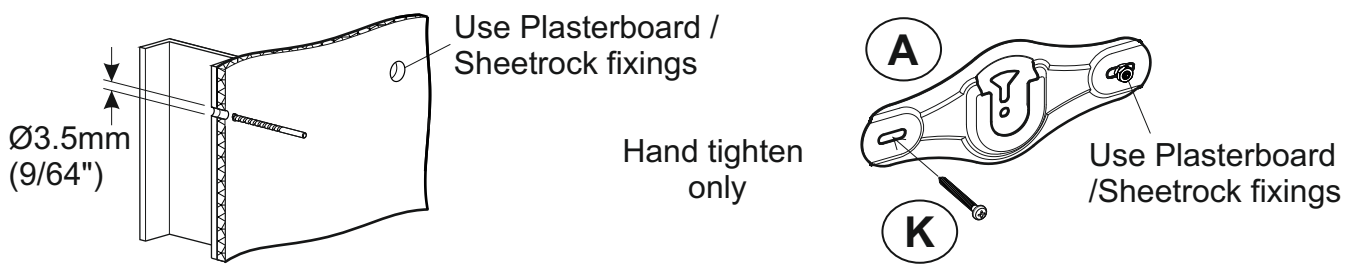

Only one fixing will be in the metal stud. The other fixings will be in plasterboard / sheetrock (see above).

8 Hanging The TV

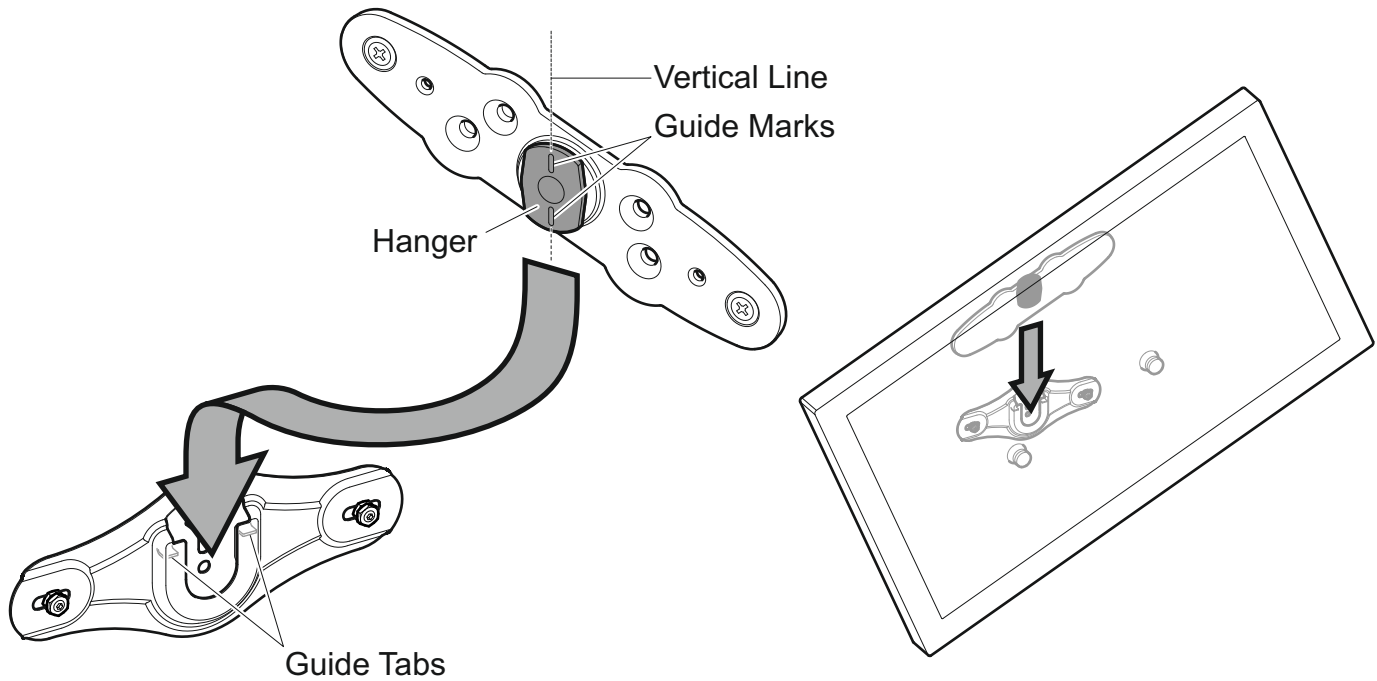

Rotate your TV so that the guide marks on the hanger are vertical. Next slide your TV down so that the hanger goes between the two guide tabs on the wall bracket. Ensure the hanger is fully engaged and rotate clockwise until your TV is level.

If cables from your TV prevent the TV resting against the wall then an alternative hanger configuration will be required (See Section 9).

TV must be parallel to wall. Use spacers / stand-offs as shown.

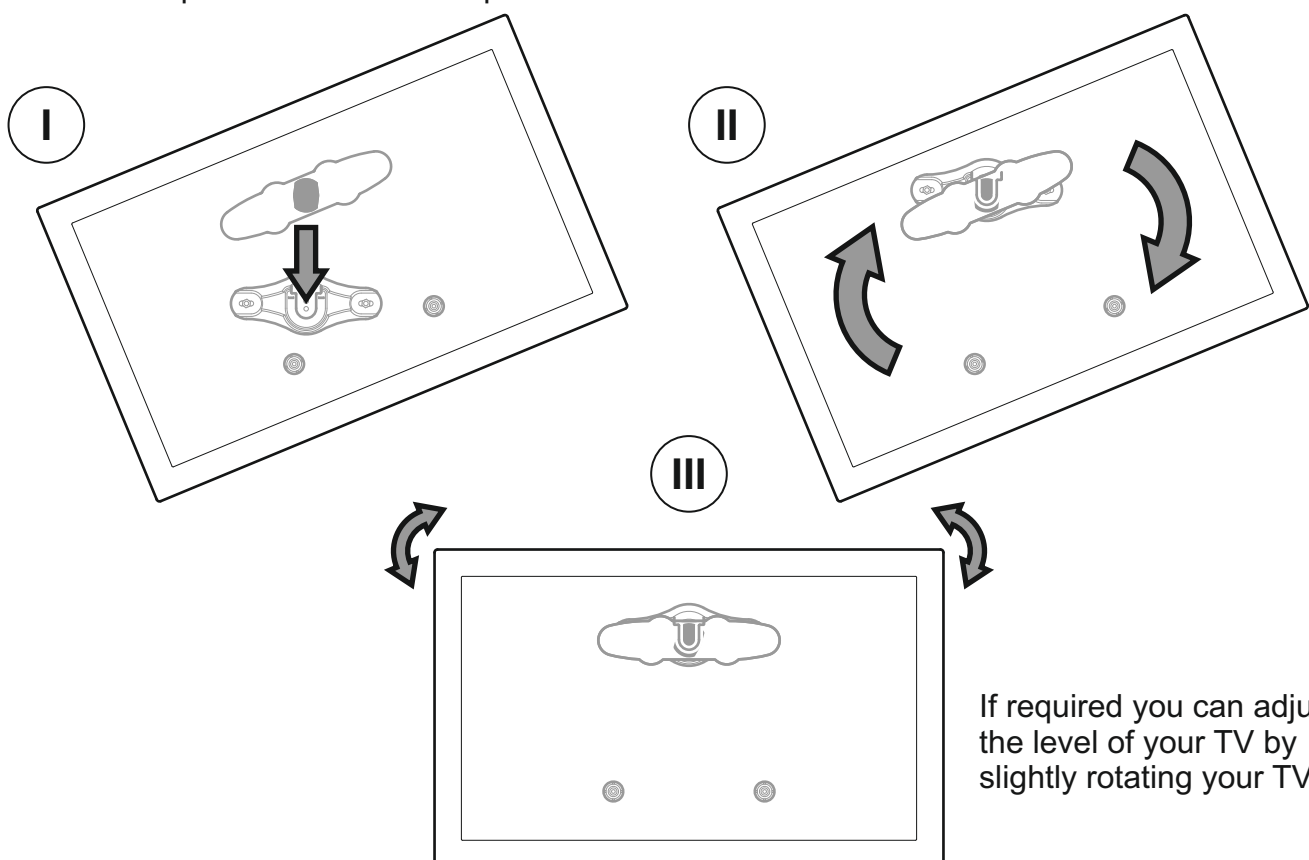

Removing the TV

This is a two person job. To remove the TV rotate anti-clockwise between 15-30° and lift TV up and out (ie reverse the movements as shown above).

9

Alternative Hanger Configurations

Alternative Wall spacings of 20mm, 30mm & 40mm can be achieved using the spacer / screw combinations listed in this section.

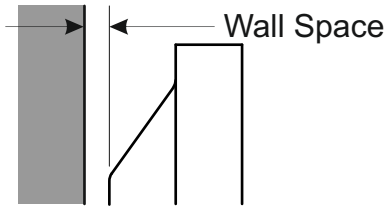

20mm Wall Space
(as shown in section 4)

Top Fixings

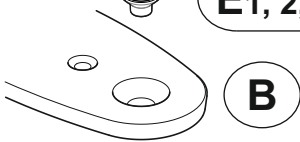
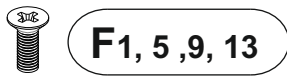

30mm Wall Space

Top Fixings

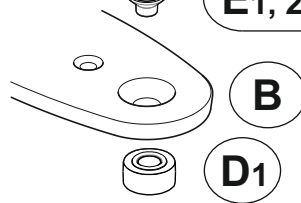
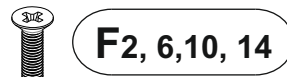

40mm Wall Space

Top Fixings

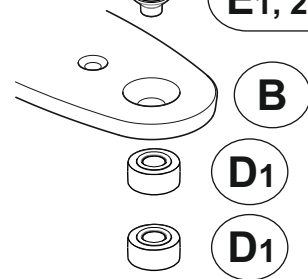
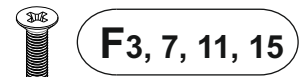

Bottom Fixings

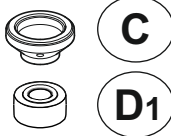
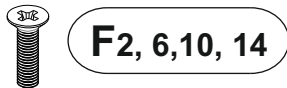

Bottom Fixings

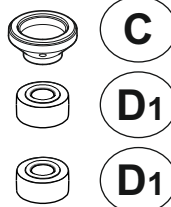
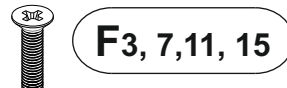

Bottom Fixings

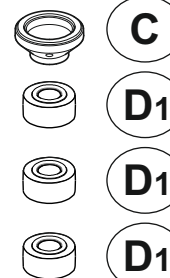
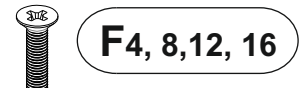

TV must be parallel to wall. Use spacers / stand-offs as shown.

- Use adapter (E1) with screws (F1), (F2), (F3) & (F4)
- Use adapter (E2) with screws (F5), (F6), (F7) & (F8)
- * Use adapter (E3) with screws (F9), (F10), (F11) & (F12)
- No adapter required with screws (F13), (F14), (F15) & (F16)

When is it necessary to use red spacers?



D2 - x4

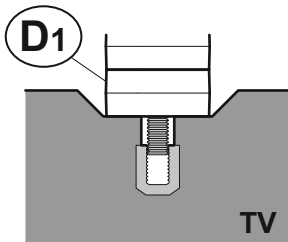

Problem
Not enough
screw engagement

It is recommended that when fitting Adaptor (B) and Stand-offs (C) to your TV you have at least 5-10mm of screw engagement. In certain circumstances you may need to use red spacers (D2) as either a replacement, or together with spacers (D1) to achieve this. Whenever you use red spacers (D2) you must use all 4 provided.

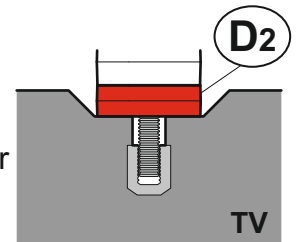

Solution
Red spacer (D2) has
replaced spacer (D1)

