

Relevant EC Directives:

- LVD 2006/95/EC
- EMC 2004/108/EC
- ROHS 2011/65/EU
- R&TTED 1999/5/EC



4718G

Wireless Programmable
Thermostat



Watersmith (UK) Ltd
Trade House, Yeovil BA22 8RT

Please leave this guide with the consumer

REV 1. Mar 2015

Helpline Number: 0845 230 5522

TABLE OF CONTENTS

Installation and Mounting	3
Installation Location.....	3
Wiring	4
Mounting	4
Battery Installation.....	5
Start/Reset	6
Normal Time Mode	6
Normal Time Setting Mode	7
Factory Defined Programs	7
Set Program	9
Temporary/Permanent Override Mode	9
Control Off/ Sleep Mode	11
Jumper Selection	12
Address Setting	13
Specification	13

Terminal block connections:

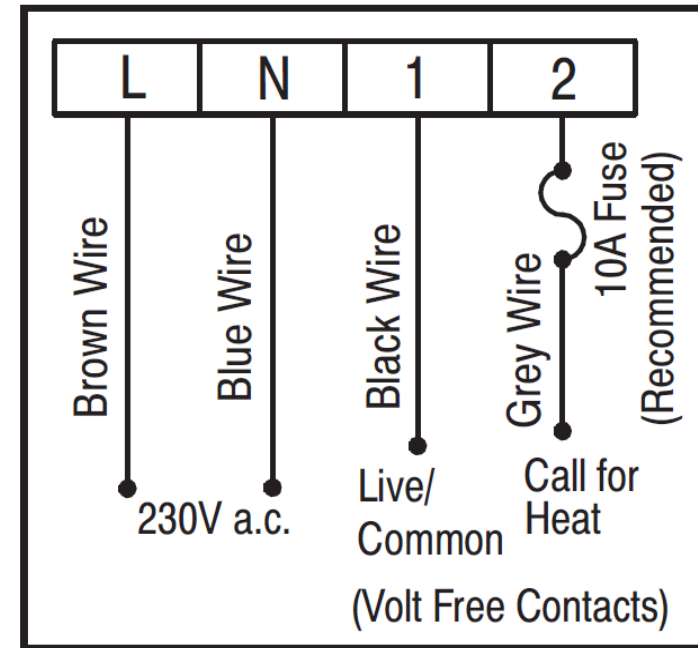

Wire product in accordance with IET Regulations

Specification:

1. Temperature measurement: 0.0 - 40 °C (0.1 °C/step)
2. Accuracy: ± 0.5 °C
3. Temperature control range: 5.0 - 35.0 °C (0.5 °C/step)
4. Terminals: 2.5mm² cable
5. Electronic control: Type 2.B action
6. Transmitter—Battery: 2 x 1.5V AAA alkaline battery
7. Receiver—Input voltage: 240Vac
8. Receiver—Output voltage: 24..240Vac 50/60Hz 10(3)A max
9. Operating temperature: 0 - 50 °C
10. Storage temperature: -10 - 60 °C
11. Sensing Element: NTC thermistor
12. Pollution Degree: 2
13. Software class rating: A
14. Rated impulse voltage: 4000V
15. Radio Frequency: 868MHz

4718G Programmable Thermostat

1. The system includes one wireless thermostat controller plus one RF receiver.
2. Transmits up to 20 meter indoor.
3. Communicates at 868MHz (Europe Standard) and designed for unlicensed operation under FCC Part 15.

Warning:

1. If there is a dead zone in the RF communication. That means the receiver may not be able to receive the message from the transmitter. Before installation, check the communication first. If the communication fails, relocate the receiver and transmitter location.
2. If the receiver has interference, set another transmitter address. Reset the transmitter and follow the set up instruction to reset the receiver.
3. It is recommended locate at least 30cm away from any metal objects (including the metal box) and at least 2 meter from any electronic devices e.g. radio TV, PC,

etc. The metal objects or electronic devices can interfere with the RF communication.

4. Do not mount onto metal wall boxes.

Installation, Mounting:

Warning:

- Switch off the thermostat and any connected electric sources before installing or performing maintenance.
- This product is for fixed wiring only.
- Must be wired in accordance with IET regulation.

Installation Location:

The thermostat (Receiver and Transmitter) should be mounted on an inner wall 1.5m above the floor in a position where it is readily affected by changes of the general room temperature with freely circulating air. Prevent direct exposure to sunlight; dripping or splashing area. Do not place this unit at a location where air circulation is low, or where it has great temperature changes (e.g. near door).

3

Jumper selection:

Delay / No Delay jumper:

	Heater	Cooler
No delay	10sec	4mins
Delay	4mins	4mins

Choose the Delay option if compressor heat is connected.

12-hours / 24-hours mode jumper:

When the 12-hours option is selected, the time is shown in 12-hours mode. Otherwise, the time is shown in 24-hours mode.

Heater / Cooler jumper:

Select the heater option when a heater is connected to the receiver. Select the cooler option when a cooler is connected to the receiver.

Address setting:

In the transmitter and receiver, there are dip switches to select the addresses. The receiver ignores messages which are sent by a transmitter with a different address setting.

12

Permanent Override Mode:

The room temperature will be maintained at the Override temperature until Override mode is released. Press <PRG> to release the Permanent Override mode.

Control Off / Sleep mode:

1. Press the <⏻> to select the sleep mode and control off mode.
The sequence is as below:
Normal Mode → Sleep Mode → Control Off Mode → Normal Mode → ...
2. Press any other keys to exit the control off / sleep mode and return to normal mode.

Sleep Mode:

At sleep mode, <⊘> icon is displayed. Transmitter stops measuring and displaying the temperature.

Control Off mode:

The LCD is fully turned off. The heater/ cooler is switched off, irrespective of the current control temperature setting.

Do not place the thermostat near heat/cool generating sources.

Wiring:

Warning: Turn off the electrical devices and receiver before wiring.

There is 4-wire cable provided

Color	Connection
Brown	230Vac Live
Blue	230Vac Neutral
Black	Common
Grey	Control (Call for Heat)

It is recommended that a 10A fuse is fitted at grey wire. (Please refer to the wiring diagram on the last page.)

Mounting:

- Mount the Transmitter on a suitable wall/ surface using the slots and screws provided.
- Find an optimum location to mount the Receiver.
- Cut a hole into the wall and feed the heating/cooling control wires through to the thermostat side.

- Using a suitable screwdriver remove the cover of the receiver by pressing in the two tabs located on both sides of the receiver.
- Attach the receiver to the wall/ surface using the slots and screws provided.
- Attach the wires to the receiver (see wiring section)
- Place the cover back onto the receiver.

Note: Please do not use the key/slots for Permanent Installation



Battery Installation:

Warning: Turn off the electrical devices and disconnect the supply to the appliances before replacing the batteries. Replace only with the same or equivalent type of batteries. Do not dispose of the used batteries with household waste. Refer to your local area for the proper disposal.

1. Pull out the battery drawer
2. Place in the new batteries according to the marking on the battery drawer.

5

Selecting the Temporary/ Permanent Override Mode

1. Press <  > to change the mode from normal to Temporary Override. **T** icon will be displayed.
2. Press <  > again, the mode changes from Temporary Override to Permanent Override mode. **P** icon will be displayed.
3. Press <  > once, the mode changes from Permanent Override to normal mode.

Review and adjust the Override temperature:

1. Press <▲>, <▼> the Override temperature is shown.
2. Hold the <▲>, <▼> for 2 seconds, the Override temperature will flash.
3. Press <▲>, <▼> to adjust the Override temperature.
4. Press <◀> to exit the Override temperature setting.
Or transmitter will auto-return to normal mode after 10 seconds.

Temporary Override Mode:

Temporary Override mode maintains until next program time is met.

10

change the hour setting.

1. Press <PRG>, the minutes will flash, press <▲>, <▼> to change the minutes setting.
2. Press <PRG>, temperature will flash, press <▲>, <▼> to change the set point.
4. Press <PRG> to set the next program.
5. The program setting sequence is as below:
Mon~Fri (P1→ P2→ P3 → P4→P5→P6)→ Sat (P1→ P2→ P3 → P4→P5→P6)→ Sun (P1→ P2→ P3 → P4→P5→P6)→...
6. Press <←> to exit the program setting mode and return to the normal mode.
Or transmitter will auto-return to normal mode after 10 seconds.

Temporary / Permanent Override Mode:

1. There are two modes in the override mode (Temporary override and Permanent override mode).
The sequence is as below:
Normal→ Temporary Override → Permanent Override→ Normal→...



9

3. Slide the battery drawer back to its position.
4. Check if the thermostat works properly or not. Press “Reset” if necessary.

Start/Reset:











1. After wiring and mounting, switch off all the connected devices. Place 2 new AAA 1.5V alkaline batteries according to the polarities marked.
LCD display will be switched on.
2. Press ‘RST’ to reset. The thermostat will be ready to control the heater / cooler.

Normal Time Mode:



1. Temperature detection starts and LCD displays the room temperature.
2. If Battery is LOW,  will be flashing. The old batteries must be replaced with new ones immediately.
3. Defrost function is activated with  displayed when temperature is 5 °C or below. Output will be forced to ON @ Heat & OFF @ Cool.
4. Below 0 °C, transmitter will display **LO**.
5. Above 40 °C, transmitter will display **HI**.

6

Normal Time Setting Mode:

1. Press , the Day of Week (1-7) will flash, press ,  to select the current Day of Week.
2. Press , the Hour will flash, press ,  to set the Hour.
3. Press , the Minute will flash, press ,  to set the Minute.
4. Press , display will jump back to the step 1.
5. Press  to confirm the settings and return to Normal Mode.
(transmitter will auto-return to normal mode after 10 seconds.)

Factory Defined Programs:

The heater/cooler turns on according to the activated program and the control temperature setting. When the heater/cooler is On. Program number and /  icons are shown. The pre-defined programs are as below:

7



Heater mode:

	Mon ~ Fri	Sat	Sun
P1	06:00 (21 °C)	08:00 (21 °C)	08:00 (21 °C)
P2	08:00 (16 °C)	10:00 (16 °C)	10:00 (16 °C)
P3	12:00 (21 °C)	12:00 (21 °C)	12:00 (21 °C)
P4	15:00 (16 °C)	15:00 (16 °C)	15:00 (16 °C)
P5	18:00 (21 °C)	18:00 (21 °C)	18:00 (21 °C)
P6	22:00 (16 °C)	23:00 (16 °C)	23:00 (16 °C)

Cooler mode:

	Mon ~ Fri	Sat	Sun
P1	06:00 (24 °C)	08:00 (24 °C)	08:00 (24 °C)
P2	08:00 (29.5 °C)	10:00 (29.5 °C)	10:00 (29.5 °C)
P3	12:00 (24 °C)	12:00 (24 °C)	12:00 (24 °C)
P4	15:00 (29.5 °C)	15:00 (29.5 °C)	15:00 (29.5 °C)
P5	18:00 (24 °C)	18:00 (24 °C)	18:00 (24 °C)
P6	22:00 (29.5 °C)	23:00 (29.5 °C)	23:00 (29.5 °C)

Set Program:

Press **<PRG>**, the hour will flash, press ,  to

8