

# evOLUTION®

www.evolutionbuild.com



Registered Design. Patent Pending 1101605.2.

## EVO200 ENGINE

### ORIGINAL MANUAL

Please read instructions before operating this tool

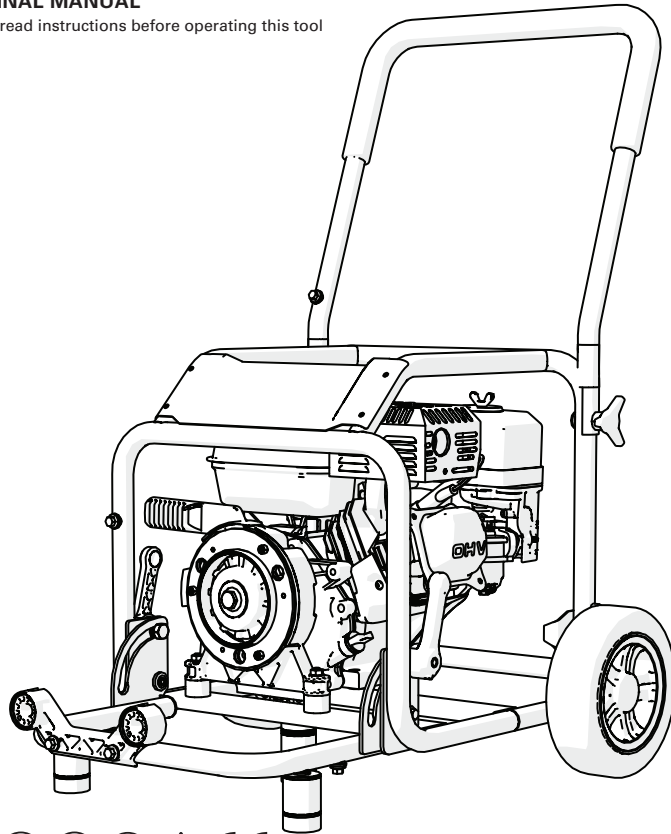

Written in UK English

Date Published: 01 / 03 / 2016

# CONNECT OUTPUT

## QUICK REFERENCE GUIDE

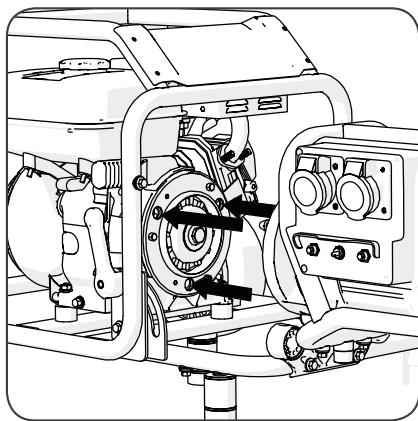

**STEP 1...**  
**LINE-UP 3 LOCATING PINS.**  
**AS ARROWS INDICATE**

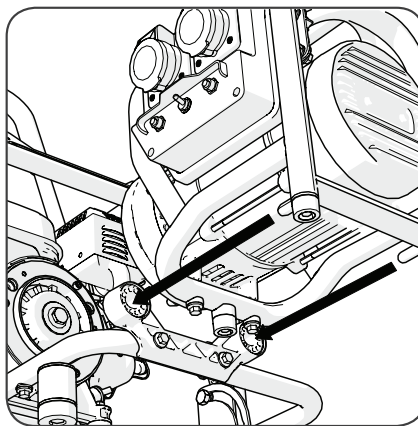

**STEP 2...**  
**LINE-UP 2 REAR STABILISER PINS.**  
**AS ARROWS INDICATE**

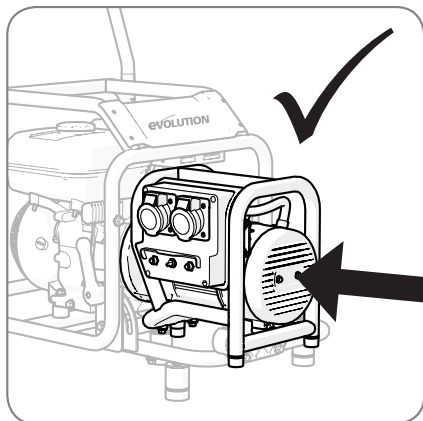

**STEP 3...**  
**APPLY GENTLE HORIZONTAL PRESSURE**  
**WITH AN OPEN-HANDED FLAT-PALM.**  
**AS ARROW INDICATES AND LOCK-IN**

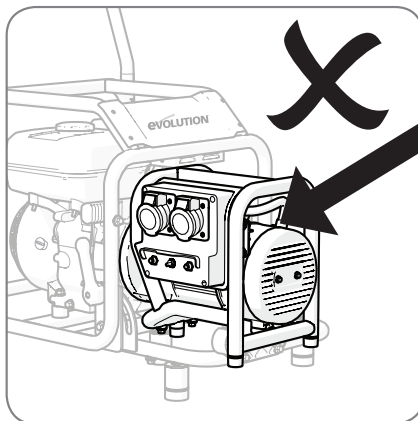

**DO NOT...**  
**APPLY SEVERE DIAGONAL DOWN-WARD**  
**PRESSURE AS ARROW INDICATES. DOING**  
**SO MAY DAMAGE THE EVO-SYSTEM!**



# SEEING IS BELIEVING!

Download a **FREE QR READER APP**  
and scan the **QR CODE** (below).

Instantly watch the **HD Evo-System Video** on your Smart Phone.

**Make sure the HD setting is on.**

If you don't have a Smart Phone, you can also watch all Evolution's videos online.



**TABLE OF CONTENTS**

<b>EC - Declaration of Conformity</b>	<b>04</b>
<b>Important Information</b>	<b>05</b>
<b>Evolution Limited Guarantee</b>	<b>05</b>
<b>General Safety Rules</b>	<b>05</b>
<b>Engine</b>	<b>07</b>
<b>Additional Specific Safety Rules</b>	<b>07</b>
<b>Symbols &amp; Labels</b>	<b>08</b>
<b>Specification</b>	<b>08</b>
<b>Machine Overview</b>	<b>09</b>
<b>Assembly</b>	<b>11</b>
<b>Operation</b>	<b>14</b>
<b>Maintenance</b>	<b>17</b>
<b>Environmental Protection</b>	<b>22</b>

**NOTICE:**

A parts diagram can be downloaded from  
[www.evolutionpowertools.com/uk/evosystem/](http://www.evolutionpowertools.com/uk/evosystem/)

**EC - DECLARATION OF CONFORMITY****We, manufacturer and importer**

Evolution Power Tools Ltd.  
Venture One  
Sheffield  
S20 3FR

**Declare that the product;**  
EVO SYSTEM ENGINE

Part numbers: EVO200

Complies with the essential requirements of the following European Directives:

2004/108/EC (until Apr 19th 2016)  
– EMC Directive  
2014/30/EU (starting from Apr 20th 2016)  
– EMC Directive  
98/37/EEC - Machinery Directive  
2000/14/EC – Noise Directive

**The following standards  
have been applied:**

EN55014-1:2000/+A1:2001/+A2:2002  
EN 55014-2:1997/+A1:2001  
EN 61000-3-2:2000/+A2:2005  
EN 61000-3-3:1995/+A1:2001  
EN 61000-3-11:2000  
EN1012-1:1996  
EN 60204-1:1997

Authorised by

**Mr Matthew J Gavins**

Group Chief Executive  
01/03/16

**All documentation is held on file at the above  
address and is available, on request for review.**

## IMPORTANT

Please read these operating and safety instructions carefully and completely. For your own safety, if you are uncertain about any aspect of using this equipment please access the relevant Technical Helpline, the number of which can be found on the Evolution Power Tools website. We operate several Helplines throughout our worldwide organization, but Technical help is also available from your supplier.

### WEB

[www.evolutionpowertools.com](http://www.evolutionpowertools.com)

### EMAIL

[enquiries@evolutionpowertools.com](mailto:enquiries@evolutionpowertools.com)

## EVOLUTION EVO SYSTEM ENGINE

Congratulations on your purchase of an Evolution Power Tools EVO SYSTEM ENGINE. Please complete your product registration online to validate your machine's warranty period and ensure prompt service if needed. We sincerely thank you for selecting a product from Evolution Power Tools.

## EVOLUTION LIMITED GUARANTEE

**Evolution Power Tools reserves the right to make improvements and modifications to the product design without prior notice. Please refer to the guarantee registration leaflet and/or the packaging for details of the terms and conditions of the guarantee.**

Evolution Power Tools will, within the guarantee period, and from the original date of purchase, repair or replace any goods found to be defective in materials or workmanship. This guarantee is void if the tool being returned has been used beyond the recommendations in the Instruction Manual or if the machine has been damaged by accident, neglect, or improper service.

This guarantee does not apply to machines and / or components which have been altered, changed, or modified in any way, or subjected to use beyond recommended capacities and specifications. Electrical components are subject to respective manufacturers' warranties. All goods returned defective shall be returned prepaid freight to Evolution Power Tools. Evolution Power Tools reserves the right to

optionally repair or replace it with the same or equivalent item.

There is no warranty – written or verbal – for consumable accessories such as (following list not exhaustive) blades, cutters, drills, chisels or paddles etc. In no event shall Evolution Power Tools be liable for loss or damage resulting directly or indirectly from the use of our merchandise or from any other cause. Evolution Power Tools is not liable for any costs incurred on such goods or consequential damages. No officer, employee or agent of Evolution Power Tools is authorized to make oral representations of fitness or to waive any of the foregoing terms of sale and none shall be binding on Evolution Power Tools.

Questions relating to this limited guarantee should be directed to the company's head office, or call the appropriate Helpline number.

## GENERAL SAFETY RULES

**WARNING:** Read all instructions. Failure to follow all instructions listed below may result in electric shock, fire and/or serious injury.

## SAVE THESE INSTRUCTIONS

### 1. Work area safety

- a. Keep work area clean and well lit. Cluttered and dark areas invite accidents.**
- b. Do not operate power tools in explosive atmospheres, such as in the presence of flammable liquids, gases or dust.** Power tools create sparks which may ignite the dust or fumes.
- c. Keep children and bystanders away while operating a power tool.** Distractions can cause you to lose control.

### 2. Electrical safety

- a. Power tool plugs must match the outlet.** Never modify the plug in any way. Do not use any adapter plugs with earthed (grounded) power tools. Unmodified plugs and matching outlets will reduce risk of electric shock.
- b. Avoid body contact with earthed or grounded surfaces such as pipes, radiators, ranges and refrigerators.** There is an increased risk of electric shock if your body is earthed or grounded.

**c. Do not expose power tools to rain or wet conditions.** Water entering a power tool will increase the risk of electric shock.

**d. Do not abuse the cord.** Never use the cord for carrying, pulling or unplugging the power tool. Keep cord away from heat, oil, sharp edges or moving parts. Damaged or entangled cords increase the risk of electric shock.

**e. When operating a power tool outdoors, use an extension cord suitable for outdoor use.** Use of a cord suitable for outdoor use reduces the risk of electric shock.

**f. If operating a power tool in a damp location is unavoidable, use a residual current device (RCD) protected supply.** Use of an RCD reduces the risk of electric shock.

### 3. Personal safety

**a. Stay alert, watch what you are doing and use common sense when operating a power tool.** Do not use a power tool while you are tired or under the influence of drugs, alcohol or medication. A moment of inattention while operating power tools may result in serious personal injury.

**b. Use safety equipment.** Always wear eye protection. Safety equipment such as dust mask, non-skid safety shoes, hard hat, or hearing protection used for appropriate conditions will reduce personal injuries.

**c. Avoid accidental starting.** Ensure the switch is in the off-position before plugging in. Carrying power tools with your finger on the switch or plugging in power tools that have the switch on invites accidents.

**d. Remove any adjusting key or spanner before turning the power tool on.** A spanner or a key left attached to a rotating part of the power tool may result in personal injury.

**e. Do not overreach.** Keep proper footing and balance at all times. This enables better control of the power tool in unexpected situations.

**f. Dress properly.** Do not wear loose clothing or jewellery. Keep your hair, clothing and gloves away from moving parts. Loose clothes, jewellery or long hair can be caught in moving parts.

**g. If devices are provided for the connection of dust extraction and collection facilities, ensure these are connected and properly used.** Use of these devices can reduce dust related hazards.

### 4. Power tool use and care

**a. Do not force the power tool. Use the correct power tool for your application.**

The correct power tool will do the job better and safer when used at the rate for which it was designed.

**b. Do not use the power tool if the switch does not turn it on and off.** Any power tool that cannot be controlled with the switch is dangerous and must be repaired.

**c. Disconnect the plug from the power source before making any adjustments, changing accessories, or storing power tools.** Such preventive safety measures reduce the risk of starting the power tool accidentally.

**d. Store idle power tools out of the reach of children and do not allow persons unfamiliar with the power tool or these instructions to operate the power tool.** Power tools are dangerous in the hands of untrained users.

**e. Maintain power tools. Check for misalignment or binding of moving parts, breakage of parts and any other condition that may affect the power tools operation.**

If damaged, have the power tool repaired before use. Many accidents are caused by poorly maintained power tools.

**f. Keep cutting tools sharp and clean.** Properly maintained cutting tools with sharp cutting edges are less likely to bind and are easier to control.

**g. Use the power tool, accessories and tool bits etc., in accordance with these instructions and in the manner intended for the particular type of power tool, taking into account the working conditions and the work to be performed.** Use of the power tool for operations different from intended could result in a hazardous situation.

### 5. Service

**Have your power tool serviced by a qualified repair person using only genuine replacement parts.** This will ensure that the safety of the power tool is properly maintained.

## SAFETY INSTRUCTIONS FOR EVOLUTION ENGINE

### **a. Petrol or diesel powered engines must never be used in unventilated closed spaces.**

The exhaust fumes produced are highly toxic and can cause 'Carbon Monoxide Poisoning' which will cause drowsiness and ultimately death. It is only permissible to run a petrol engine indoors if the building can be very well ventilated and the exhaust fumes can be captured and ducted to the outside through an exhaust extraction/scavenger system.

**b. The engine should be positioned on a firm level surface.** The wheels should be locked, so that the engine cannot move during operation.

**c. The engine should not be run at speeds that exceed the maximum speed on the rating plate.** Operating an engine at excessive speeds increases the likelihood of component failure and consequent accidents.

**d. Do not tamper with components that regulate the engines speed.** You may alter the factory set running parameters.

**e. Use only the type of fuel listed in this Instruction Manual.** Using fuel with an octane rating less than that specified can lead to excessive engine wear and premature engine failure.

**f. Keep the area around the engine clear, clean and tidy.** Never allow any combustible material (timber, plastic, cardboard, canvas etc) near a running engine.

**g. Do not use in or near to potentially explosive atmospheres.** Dust laden atmospheres as can be found in some industrial buildings (Flour Mills, Timber Mills) have an explosive potential.

**h. Regularly check the fuel system for leaks. Hoses and unions should be checked for deterioration or chafing.** Check the fuel tank for damage or for a poorly fitting or worn fuel cap. Any defects must be rectified before the engine is used.

**i. Always stop the engine and allow it to cool down before refuelling.** Try to avoid any fuel spillage (often caused by 'overfilling' the tank) and clean up any spilt fuel immediately. The application of dry sand is an effective way of neutralising fuel spills. Do not allow sand to come into contact with any part of the engine

**k. Do not allow the engine to run out of fuel while a generator under load is attached.** Surging of the engine as it uses the last of the fuel could cause damage to connected electrical equipment.

**l. When transporting the engine in a vehicle ensure that the fuel tap is turned off.** To minimise the risk of fuel spillage the engine should be secured by ropes etc to the load area of the vehicle so that it cannot move during transportation. The engine should be secured in as level an attitude as possible.

**m. For long term storage we recommend that the fuel system of the engine is drained.** During long term storage additives in modern fuels can precipitate from the fuel and block jets and valves in the fuel system.

**n. Store the machine in a secure and well ventilated area.** Unauthorised personnel should not have access to this machine.

## SAFETY INSTRUCTIONS FOR FUEL FILLING

**a. Select level bare ground, remote from any buildings as a refuelling station.** Ensure that there is no combustible material in the immediate vicinity.

**b. Smoking, using a naked flame or producing sparks is strictly forbidden whilst refuelling.** Petrol is highly flammable and its vapours are combustible.

**c. Ensure that the fuel tap is turned 'off'. This will ensure that fresh fuel does not 'flood' the engines carburettor.**

**d. The engine must be turned 'off' and allowed to cool before refuelling is attempted.** Inadvertent fuel spillage onto a hot engine can result in the risk of fire.

**e. Any fuel spills must be dealt with immediately. If petrol contaminates any clothing the operator must change clothes.** Do not rely on the fuel evaporating from the clothes. Wash or launder the clothing when the fuel has evaporated from the material.

**f. The use of a funnel during refuelling is recommended.** Use of a funnel will minimise the risk of fuel spillage.











**g. Fill the tank with the correct grade of unleaded fuel to a level approximately half way up the fuel filter.** Pour the fuel into the tank carefully and do not try to fill the tank completely. Pour the petrol slowly to avoid air traps during filling that could cause fuel spillage.

**h. Check the fuel tank cap, and replace as soon as refuelling is completed.** The cap has a bayonet type connection. Check that it is correctly installed and seated before slowly turning on the fuel tap.

**i. Check for any fuel leaks throughout the fuel system.** Do not attempt to start the engine if a fuel leak is suspected. Any detected leak must be repaired by a suitable qualified technician.

**j. Observe all national and/or local regulations about the storage and use of petroleum products.** All local bye laws should be observed.

**SYMBOLS AND LABELS**

Symbol	Description
V	Volts
A	Amperes
Hz	Hertz
Min <sup>-1</sup>	Speed
~	Alternating Current
n <sub>o</sub>	No Load Speed
	Wear Safety Goggles
	Wear Ear Protection
	Wear Dust Protection
	Do Not Touch
	Warning
	Caution: Hot Exhaust Do Not Touch
	Caution: This is a four stroke engine. Fill with petrol only. Do not fill with Diesel oil.
	Allow the motor to cool before opening the fuel cap. The vapour is extremely flammable and may ignite on contact with a hot surface or flames
	Restriction of Hazardous Substances Directive
	Waste electrical and electronic equipment
CE	CE certification

**SPECIFICATION**

**Engine Specification - EVO200**

Engine Brand:	EVOLUTION
Engine Type:	4-Stroke (Single Cylinder)
Engine Displacement:	200cc
Engine Power:	6.5hp
Spark Plug Replacement:	SINO F7TC NGK BP6ES CHAMPION N9YC
Spark Plug Gap:	0.8mm
Air Filter:	Washable air filter element
Fuel Type:	Standard Unleaded Petrol
Speed:	3150min <sup>-1</sup> (Factory set governed)
Fuel Tank Capacity:	3.1 L
Lubricating Oil Capacity:	0.6 L (10W 40 Automotive Oil)
Starter:	Recoil
Transmission:	EVO-SYSTEM Technology
Oil Warning:	Oil Low Sensor
Weight (Without Accessory):	29.1kg
Wheels:	ø200mm
Brake:	Manual Foot Brake Locking the Wheels
Frame:	External tubular steel (1") frame Deployable Accessory Frame
Handle:	Fold-away



## Machine Overview

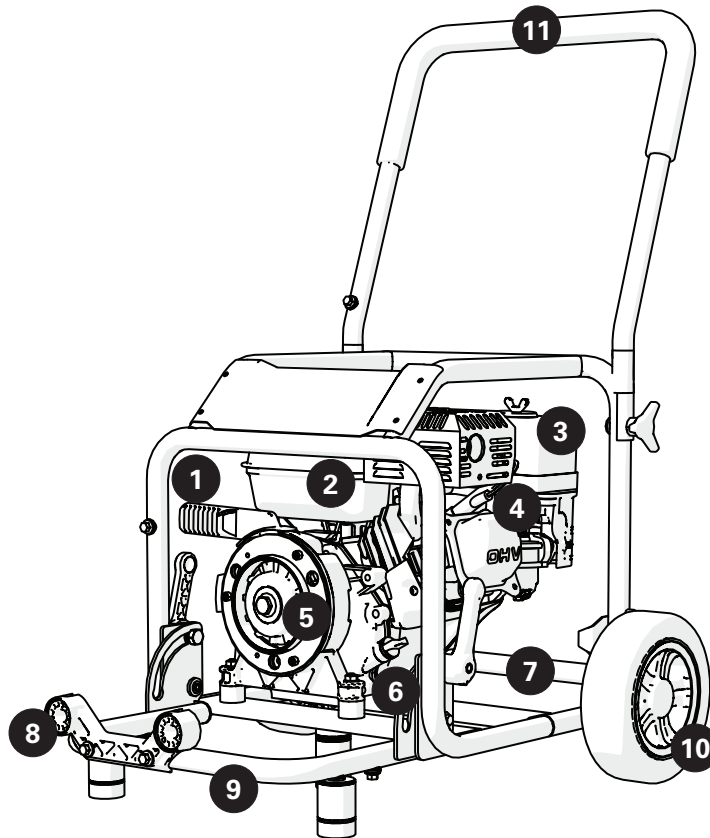

- |                                 |                                      |
|---------------------------------|--------------------------------------|
| 1. 'Uni-Coupling' release lever | 7. Wheel Foot Brake                  |
| 2. Fuel Tank                    | 8. Accessory Mounting Sockets        |
| 3. Air Filter Cover             | 9. Deployed Accessory Mounting Frame |
| 4. Spark Plug                   | 10. Transportation Wheels            |
| 5. Evolution 'Uni-Coupling'     | 11. Transportation Handle            |
| 6. Oil Level/Filler Cap         |                                      |

### Machine Overview

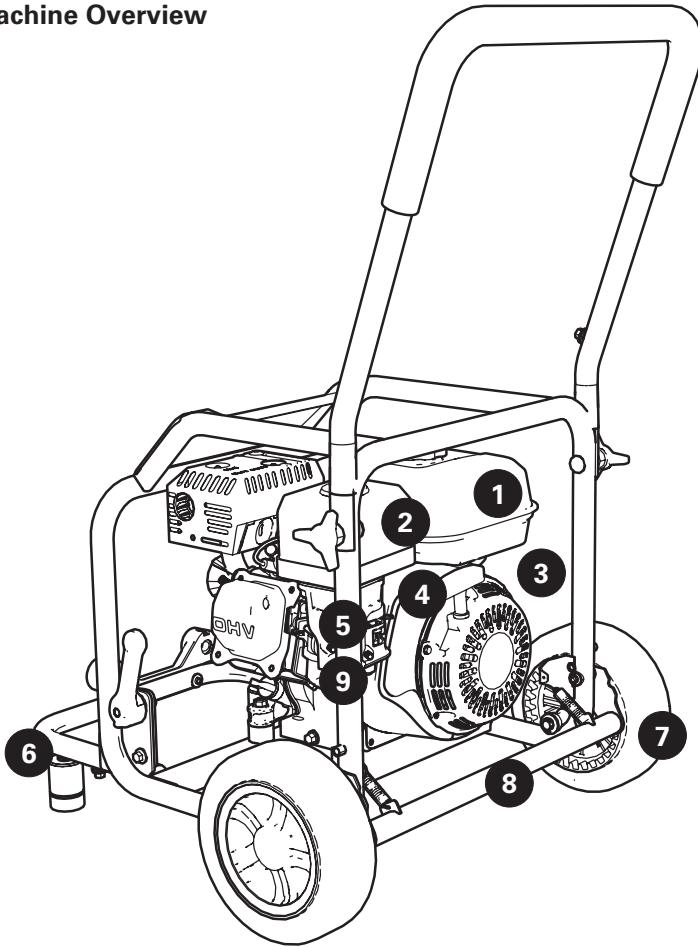

1. Fuel Tank

2. Air Filter Cover

3. Engine Switch

4. Recoil Starter

5. Choke Control

6. Deployed Accessory Mounting Frame

7. Transportation Wheels

8. Wheel Foot Brake Handle

9. Fuel 'ON/OFF' Tap

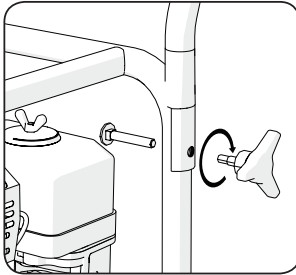

Fig 1

## ASSEMBLY

Your EVO-SYSTEM Engine needs some minor assembly and will need minimal operator adjustments to commission the machine.

### 1. Attaching the Transportation Handle

The Transportation handle should be attached to the machines external tubular frame using the two  $\varnothing 8$  mm coach bolts and plastic headed thumb nuts. **(Fig. 1)**

**Note:** During storage or when transporting the engine in a vehicle it may be convenient to remove the transportation handle or place it in the 'stowed' position.

#### To stow the transportation handle:

- Undo the two plastic headed thumb nuts so that they are engaged onto the coach bolts by only a couple of threads.
- Spring the transportation handle outwards and away from the frame, so that it can be rotated forwards.
- Lay the handle horizontal on the main external frame.
- Tighten the two thumb nuts just sufficiently for them not to come loose in transit.

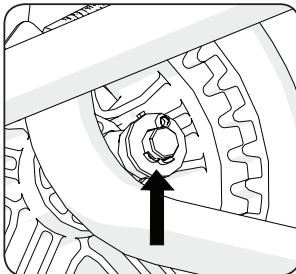

Fig 2

### 2. Attaching the Wheels

The Transportation Wheels fit into bosses located at the bottom rear, and at either side of the external frame.

#### To fit the wheels:

- Slide the wheel axle through the mounting boss.
- Slide a washer over the protruding axle.
- Slide a split pin through the hole in the axle.
- Bend the split pins tines around the axle perimeter in opposite directions. **(Fig. 2)**
- Check that the wheels spin freely.
- Check the operation of the wheel brake by applying and releasing it several times, spinning the wheels between applications. The brake must lock both wheels securely. **(Fig. 3)**

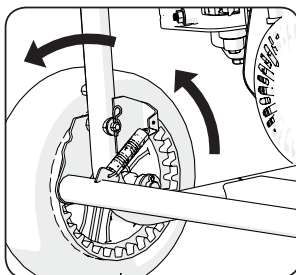
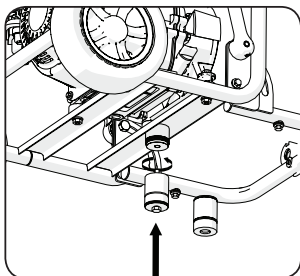

Fig 3

**Note:** A light coating of grease applied to the axle before assembly will aid lubrication of the axle in use.



**Fig 4**

### 3. Attaching the 3 Support Feet

Three support feet are provided. All three are the same and are inter-changeable with each other. Two of the support feet fit onto to the accessory mounting frame near the front corners. The third support foot fits onto a boss located under the front bottom cross member of the external frame.

#### To fit the support feet:

- Insert  $\varnothing 8$ mm bolts through the support feet with the bolt heads positioned within the domed rubber feet.
- Screw the bolts into the captive nuts at the three locations mentioned.
- Tighten the bolts securely using a suitable spanner (not provided).

**Note:** Access to the boss under the frame cross member may be gained by tipping the machine backwards. Enlist competent help to tilt the machine, and ensure that the wheel brake is applied before the machine is tipped backwards. **(Fig. 4)**

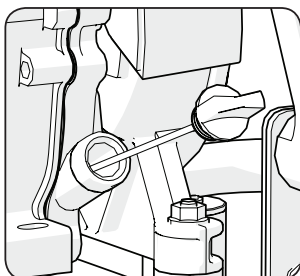

**Fig 5**

### 4. Initial filling & checking the oil level

#### **WARNING: This machine does not come filled with oil.**

No attempt to start the engine must be made until the crank case is filled to the correct level with the correct grade of oil. Oil (**not provided**) should be poured into the machine through one of the 2 Oil Filler/Level Caps.

**Note:** Only one oil filler maybe accessible. Oil capacity is approximately 0.6L of 10W 40 Automotive oil (available at all good motor factors and most petrol stations).

These Caps unscrew from the machines engine casing and incorporate an oil level dip stick. **(Fig. 5)** Take care not to spill any oil.

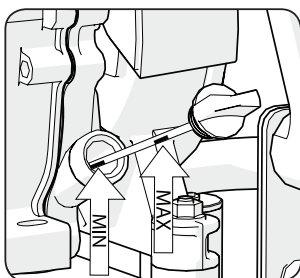

**Fig 6**

**Note:** It is important that when checking the oil level the machine is on a stable, horizontal and level surface with the engine stopped and cold. Two index marks are provided on the dipstick. The oil level should be maintained near the top mark. **(Fig. 6)**

- Remove the relevant Oil Filler/Level Cap and wipe the dipstick with a clean dry cloth.
- Pour in the required amount of oil. **(600ml)**
- Allow the oil to settle for a few seconds.
- Insert the dipstick into the machine but do not screw the Cap into the casing.
- Withdraw the dipstick and visually check the oil level.
- Adjust as necessary.
- When the level is correct tighten the Oil Filler/Level Cap securely into the engine casing.

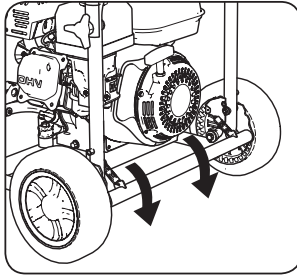

Fig 7

**Note:** Change the oil according to the Maintenance Summary Chart (Refer also to MAINTENANCE – Engine oil replacement )

## 5. Connecting an accessory

Your EVO-SYSTEM Engine has a unique coupling that enables a variety of Evolution accessories to be connected to and be driven by this machine. This coupling is engineered to very fine tolerances and must be kept clean and free from dirt, debris etc. A cover for coupling protection is provided with each accessory and should be used whenever the accessory is 'remote' from the engine. If you experience difficulty in accessory connection, it could be because the accessory location pins, or the annuli of either the accessory or the engine are contaminated or damaged. Refer to the MAINTENANCE section 5 which gives details of how to clean the annuli mating rings and the accessory locating pins.

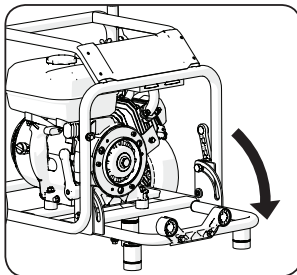

Fig 8

**Note: The EVO-SYSTEM Engine has a micro switch incorporated within the coupling design that senses when an accessory has been successfully attached to the machine. The engine will not start without an accessory being connected. It cannot be run as a 'stand alone' machine.**

- Lock the Transportation Wheels using the wheel brake. **(Fig. 7)**
- Release the Accessory Mounting Frame by rotating the locking levers to their unlocked (down) position and push-in.
- Deploy the Accessory Mounting Frame. **(Fig. 8)**

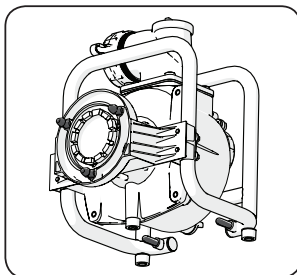

Fig 9

**Note:** It is important that the frame is correctly deployed for successful accessory connection.

- Lock the frame into position by pulling out and returning the locking levers to their locked (upright) position.

**Note:** Each accessory is equipped with 3 locating pins, and 2 rear stabilising pins. The 3 locating pins lock into the 'Uni-coupling' the 2 stabilising pins slide into the sockets in the Accessory Mounting Frame.

- Hold the accessory by its external frame and offer it up to the engine. Visually align the 3 locating pins and 2 rear stabilising pins. **(Fig. 9)** Enlist competent help if necessary. The generator in particular is heavy and help with lifting may be required.
- Holding onto a convenient part of the external engine frame can aid the operator achieving and maintaining alignment when connecting an accessory.
- Gently push the accessory into the engine. Keep the 3 locating pins and the two stabilising pins aligned with their respective docking positions. The internal coupling between the engine and the accessory will be made automatically. No component

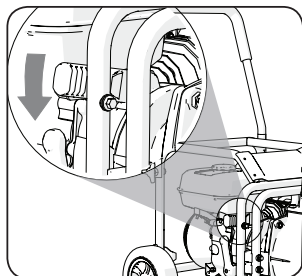

**Fig 10**

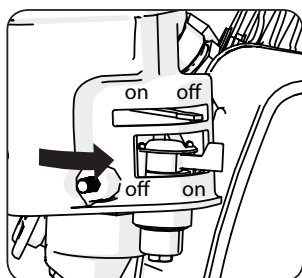

**Fig 11**

alignment or adjustments are necessary.

- Be gentle and patient, the coupling is precisely engineered and no great force is required to connect the accessories. Once the operator has mastered the 'technique', accessory connection will become straight forward.
- Firmly push the engine and accessory together until the 'click' of docking is heard. The Uni-coupling release lever (**Fig. 10**) will return to its neutral position.

## 6. Disconnecting an accessory

**Note:** Before attempting to remove any accessory ensure that the engine is switched off, stationary and **cold**. Some components (e.g. the exhaust system) can remain very hot for a considerable time after the engine is switched off, and there is a burn risk for the unwary user.

- Ensure that the engine is on a clean, stable and horizontal surface.
- Allow the engine and the attached accessory to fully cool down from their working temperatures.
- Hold the accessory at a convenient point on its external frame.
- Operate the 'Uni-coupling' release lever with one hand (**Fig. 10**) whilst gently easing the accessory outwards releasing it from the coupling with the other hand.
- Using both hands gently pull the accessory from the engine. The accessory may be heavy (e.g. the generator) so enlist competent help with accessory removal if necessary .
- Store the accessory carefully in a secure location for future use Refit the coupling protection cover.

## OPERATION

**Note:** The EVO-SYSTEM Engine cannot be operated without an accessory being connected. Some components will become very hot during operation (e.g. the exhaust system and surrounding components). The operator should employ due diligence and care when using this machine.

- Position the engine on firm level ground and lock the transportation wheels by operating the wheel brake.
- Deploy the Accessory Mounting Frame to the fully down position.
- Connect the required accessory.
- Check the oil level and fuel levels.

**Note:** If either fluid levels require 'topping up' follow previously outlined instructions (Refer to 'Checking Oil Level' and 'Safety Instructions For Fuel Filling'). Do not try to start the engine until fluid levels have been checked and adjusted and a visual safety check has been completed.

### 1. Starting your EVO-SYSTEM Engine

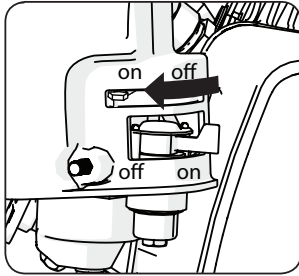

Fig 12

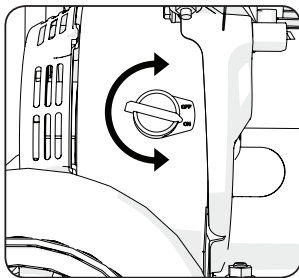

Fig 13

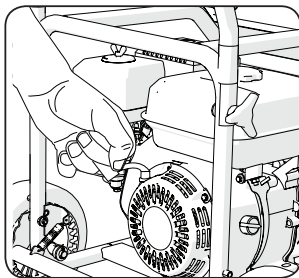

Fig 14

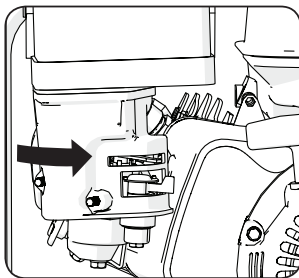

Fig 15

**Note:** A visual safety check should be carried out before attempting to start the engine. Particularly check for any fuel or oil leaks, the integrity of accessory attachment and the stability of the machine.

Rectify any faults found before attempting to operate the machine.

- Ensure that the transportation wheels are locked by applying the wheel brake.
- Turn the fuel tap lever to the 'On' position. **(Fig. 11)**
- Set the choke lever to the 'Choke On' position. **(Fig. 12)**
- Turn the engine ignition switch to the 'ON' position. **(Fig. 13)**
- Steady the EVO-SYSTEM Engine by holding the external frame at a convenient point.
- Use your other hand to grip the recoil starter cord handle. **(Fig. 14)**
- Pull the recoil starter cord slowly until resistance is felt indicating that the starter is engaged.
- When resistance is felt pull the cord sharply.
- Continue this procedure until the engine starts.
- Usually the choke can be returned to the 'off' position almost immediately when the engine fires up, but this will depend upon ambient temperatures, operating conditions etc and operators discretion will be required. **(Fig. 15)**

**Note:** When using the generator accessory the engine must be run at 3150 min<sup>-1</sup> the factory set governed speed.

## 2. Stopping your EVO-SYSTEM Engine

**Note:** The procedure for stopping the engine can be influenced by the accessory that is connected.

If the generator accessory has been connected to the engine, it is important that before stopping the engine all electrical loads are disconnected from the generator AC outlet sockets. Failure to do so may cause damage to any connected appliances. See the relevant 'Instruction Manual(s)' for any specific requirements or advice regarding machine shut down.

- Turn the engine ignition switch to the 'OFF' position.

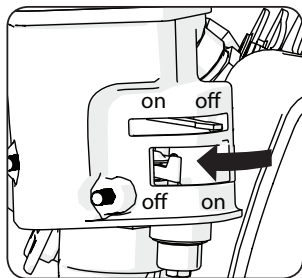

**Fig 16**

- Allow the engine to come to a complete stop and turn the fuel tap to the 'OFF' position. **(Fig. 16)**

### 3. Transporting your Evolution Engine

Although compact this machine is heavy. Enlist competent help if necessary when transporting this machine.

**Note:** This machine can be transported with an accessory connected or if more convenient (where space limitations apply or where manoeuvring is difficult) with the accessory disconnected and the accessory mounting frame in the stowed position.

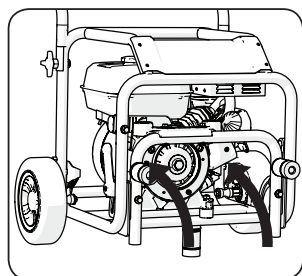

**Fig 17**

#### To stow the accessory mounting frame:

- Push the two locking levers to their downwards (unlocked) position to release the deployed frame.
- Fold the frame and push inwards and upward into its stowed position. **(Fig. 17)**
- Pull outwards slightly the locking levers and rotate them forwards to their locked position (upward).

#### To use the Transportation Wheels:

- Apply the wheel brake.
- Pull back slightly on the transportation handle to allow the wheels to take the full weight of the balanced machine. The operators hands should be widely spaced, holding the handle at its curved ends. When bringing the machine 'to balance' the operator may also find it helpful to place a foot on the wheel brake bar.
- Keep the machine balanced. Enlist competent help if necessary.
- Release the wheel brake and wheel to the new location.
- Re-commission the machine as necessary.

## ATTENTION!

Take great care to ensure that the engine (or accessory) is not dropped during loading / unloading!

#### Vehicular Transportation

**WARNING:** This machine requires at least a two man lift. Prepare the vehicle in advance so that it is ready to receive the engine.

- Although compact, this machine is heavy. To reduce the risk of injury, get competent help whenever you have to lift this machine.
- To reduce the risk of back injury, hold the machine close to your body when lifting. Bend your knees so you can lift with your legs, not your back. Lift by using convenient areas of the external frame.
- Lift the engine into the vehicle and secure in as level an attitude as possible with ropes, tie down straps etc so that the engine cannot move during transportation.



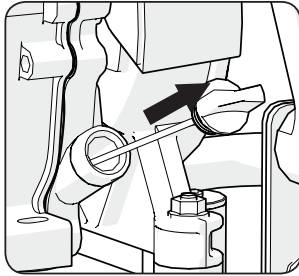

Fig 18

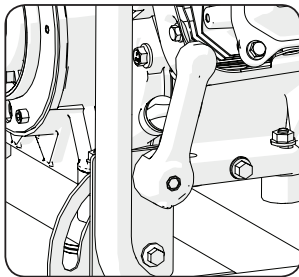

Fig 19

## MAINTENANCE

Regular maintenance is essential to keep your EVO-SYSTEM Engine and its accessories in serviceable condition. We recommend that only competent operators who have experience in servicing and maintaining petrol engines attempt these procedures. If in doubt have the machine serviced at an Evolution approved Service Centre.

### 1. Engine oil replacement

**Note:** Engine oil is easier to replace when the engine has been run up to temperature and the oil is warm.

- Ensure that the engine is positioned on a hard level surface.
- Remove the oil filler cap. (**Fig. 18**)
- Place a suitable oil collection pan under the engine.
- Remove the oil drain plug so that the oil can drain completely from the engine. (**Fig. 19**)

**WARNING:** Be careful. Contact with used engine oil can be harmful. The oil could be very hot (burn risk) and some operators may experience irritation if the oil contaminates exposed skin.

- Check the oil drain plug and its gasket.
- Check the oil filler cap and its 'O' ring gasket.
- Replace any non-serviceable parts.
- Re-install the oil drain plug and tighten firmly.
- Refill the engine with the correct grade of engine oil to the correct level.
- Refit the oil filler cap.
- Check for leaks and spillages, and deal with as necessary.

**Note:** Used engine oil should be disposed of in an environmentally safe way. Check with your Local Authority for the nearest used oil re-cycling facility.

### 2. Spark Plug - Checking and replacement

After approximately 50 hours of operation the spark plug should be removed for checking, cleaning and resetting.

#### To remove and reinstall the spark plug:

- Ensure that the engine is switched 'OFF' and the fuel tap is in the 'OFF' position.

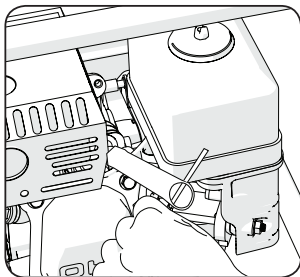

**Fig 20**

**WARNING:** The engine should be cold before commencing the spark plug removal procedure.

- Pull the HT lead from the spark plug.
- Using the spark plug socket and 'T'-bar (supplied) remove the spark plug. **(Fig. 20)**

A serviceable spark plug in good condition should exhibit light tan deposits on the plug nose. Remove these deposits with a stiff brass wire brush.

- Check the electrode gap of the plug using a set of feeler gauges.
- Adjust if necessary. The gap should be 0.7mm to 0.8mm
- Re-install the spark plug.
- Hand tighten the plug using the spark plug socket.
- Only use the spark plug socket to produce the gas tight seal which is achieved by the last ½ turn of the spark plug.
- Reattach the HT lead to top of the spark plug.

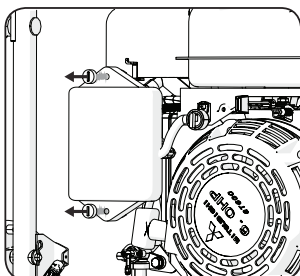

**Fig 21**

### 3. Air Filter

**WARNING:** Never run the engine without the air filter element fitted.

After approximately 50 hours of use the air filter element should be removed from its housing, cleaned and refitted.

#### To remove:

- Ensure that the engine is switched 'OFF' and the fuel tap is in the 'OFF' position. The engine should be cold.
- Unscrew the wing nut from the Air Filter housing and remove it and its large plate washer and rubber sealing gasket. **(Fig. 21)**
- Carefully store these parts for later re-installation.
- Manoeuvre the Air Filter Housing from the machine
- Remove the Air Filter Element from the housing. **(Fig. 22)**

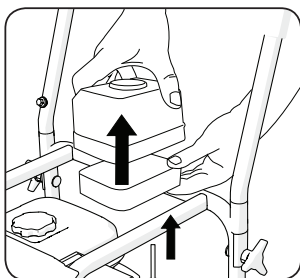

**Fig 22**

The Air Filter Element is washable. Clean the element thoroughly using an environmentally friendly water based degreasing agent. Allow to dry naturally. Do not refit a wet or damp element.

- When dry the element should be lightly sprayed with light machine oil. This will improve the efficiency of the air filter.

#### To refit:

- Install the cleaned element into the Air Filter Housing.
- Manoeuvre the Air Filter Housing into the machine and carefully locate it on the carburettor adaptor plate.
- Ensure that all rubber gaskets are serviceable and correctly seated.
- Replace the wing nut with its large washer and securely tighten.

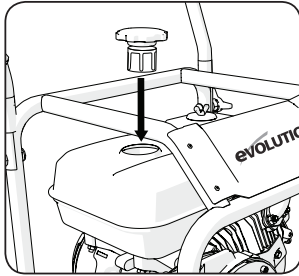

Fig 23

#### 4. Fuel Tank Filler Filter

Occasionally visually check the condition of the fuel tank filter (when refuelling is ideal). If there is any sign of deposit build up, remove the filter from the tank and clean.

- Clean the filter with environmentally friendly water based degreasing agent and if necessary blow the fine mesh through with clean, dry compressed air.
- Allow to dry thoroughly before refitting.
- When refitting ensure that the 2 cut outs on the top edge of the filter line up with the cut outs in the fuel tank filler neck. (Fig. 23)

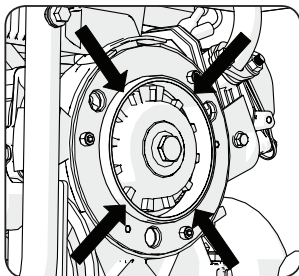

Fig 24

#### 5. Annular Rings and Accessory Locating Pins

The annular rings ensure the precise mating of an accessory to the EVO-SYSTEM Engine.

- The male annular ring is located around the engine output shaft. (Fig. 24)
- The female annular ring is located around the accessory input shaft. (Fig. 25)

The annular rings should be kept scrupulously clean, and checked at every connection or disconnection. If any dirt or debris is found it should be removed using a slightly damp soft cloth.

All other mating surfaces between engine and accessory should be kept as clean as possible.

The three (3) locating pins and two (2) stabilising pins are positioned on the accessory.

These pins should also be kept scrupulously clean and free from dirt or other contamination.

A very light spray coating of silicone machine oil occasionally applied to their surface will aid accessory connection.

A cover for coupling protection is provided with each accessory and should be used whenever the accessory is 'remote' from the engine. The engine is also supplied with a coupling protection cover.

**This should be fitted whenever an accessory is removed.**

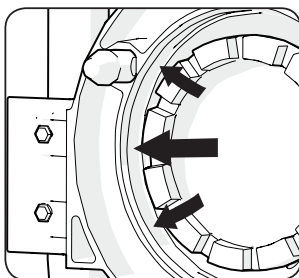

Fig 25

#### 6. Replacement of Plastic Annular Ring

The EVO-SYSTEM Engine (Male) annular ring can be replaced if damage or wear is detected.

##### To replace the annular ring:

- Remove the damaged ring by carefully cutting through it with a sharp craft knife.
- Clean away any dirt, debris or Plastic residue from the annular ring mounting flange.
- Position the Plastic ring onto its flange and push it fully home so that it lies flush against the engine casing.

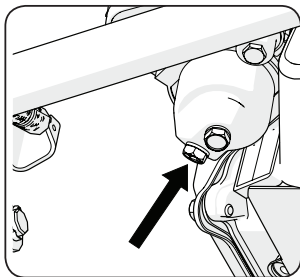

**Fig 26**

**Note:** The Plastic ring is not 'handed' and can fit onto the flange either way round.

- Check the installation.

### **7. Uni-coupling Clutch**

Drive from the engine to the accessory is transmitted by a 12 toothed sprung loaded dog clutch coupling. This should be kept clean and the teeth regularly inspected for wear (preferably at every connection or disconnection). Any debris or dirt etc that becomes lodged between or on the teeth could cause premature wear and so should be removed as soon as possible. Clean with a slightly damp soft cloth (a pipe-cleaner or small brush may be useful to access the spaces between the teeth). Lightly spray the metal parts of the Uni-coupling with a high quality Silicone Spray. Lubricant as detailed in the Maintenance Summary Chart. Avoid spraying rubber components.

### **8. Recoil Starting System**

The ventilation slots should be kept clean and free from any obstructions. Remove any foreign matter from the ventilation slots. Do not use sharp, pointed instruments pushed through the slots in an attempt to dislodge any obstructing material.

### **LONG TERM STORAGE**

If your EVO-SYSTEM Engine is not going to be used for a period of 4 months or more (e.g. over the winter period) the operator should consider preparing it for long term storage. This will keep the engine in optimum condition for re-commissioning when required.

- Drain all the fuel from the fuel tank and carburettor into a suitable approved container.
- A drain plug can be found underneath the carburettor float bowl. **(Fig. 26)**
- Replace the drain plug when all the fuel has been removed.
- Remove the spark plug.
- Pour approximately one tablespoon of clean engine oil into the spark plug hole.
- Ensure that the engine ignition switch is in the 'OFF' position.
- Gently pull the recoil starter a few times.
- Replace the spark plug.
- Gently pull the recoil starter until resistance is felt (this will mean that the piston is on its compression stroke with both valves closed). Stop pulling the recoil starter.
- Store the engine in a secure, dry and well ventilated location, under a cover to prevent dust, debris etc from settling on the machine.

**MAINTENANCE SUMMARY CHART**

ITEM	COMMENTS	DAILY	1 MONTH ( or 20 hours)	3 MONTH ( or 50 hours)	6 MONTH ( or 100 hours)
<b>Visually Check</b>	All fuel lines & unions All Electrical Leads	*			
<b>Spark Plug</b>	Check condition Clean & adjust gap Replace if necessary			*	
<b>Engine Oil (10W 40)</b>	Check Oil Level	*	After 1st MONTH	*	
	Change / Replace Oil				
<b>Air Filter</b>	Clean Replace if necessary			*	
<b>Fuel Filter</b>	Clean	*			*
	Replace if necessary				
<b>Recoil Starting System</b>	Ensure ventilation slots are unobstructed	*			
<b>Uni-coupling</b>	Clean Spray (with Silicone Lubricant)	After every 25 hours of use lightly spray through the 3 locating pin connection points.			
<b>Internal Rubber Element</b>	Visual Check	<b>Every 250 hours of use* - replace if worn or damaged.</b> This procedure needs to be carried out carefully and a separate instruction sheet is available from <a href="http://www.evolutionpowertools.co.uk/evosystem.html">www.evolutionpowertools.co.uk/evosystem.html</a> . If you do not feel confident, please contact the helpline for further help and advice.			

\* Evolution's internal test data.

<b>CONDITION</b>	<b>POSSIBLE CAUSE</b>	<b>ACTION</b>
<b>Engine will not start/cuts out</b>	Fuel Starvation	Replenish fuel in the fuel tank
	Accessory not connected or not connected successfully	Carefully connect required accessory
	Low engine oil level causing safety shutdown	Check and replenish engine oil
	Engine positioned on a slope causing low oil level shutdown	Check oil level. Reposition engine onto level ground
<b>Engine runs erratically</b>	Poor compression due to a loose spark plug	Check spark plug. Refit and retighten
	Damaged or worn spark plug	Replace spark plug
	Choke left 'On'	When engine is at operational temperature ensure Choke is in the 'Off' position
	Air Filter clogged	Remove clean and replace air filter
<b>Engine power down</b>	Wrong grade of fuel	Replace fuel with the correct grade of unleaded petrol

**ENVIRONMENTAL PROTECTION**

Waste electrical and mechanical products should not be disposed of with household waste. Please recycle where facilities exist.

Check with your Local Authority or retailer for recycling advice.



# DID YOU KNOW YOU CAN ALSO BUY...

## ENGINE UNIT

- ✓ Wheel kit provides mobility.
- ✓ Folding handle for storage.
- ✓ Robust & durable steel frame.

• Power: 6.5hp, 4-Stroke • Power Take Off (PTO)  
• Easy Recoil Start • Fuel Capacity: 3.1L • EVO200

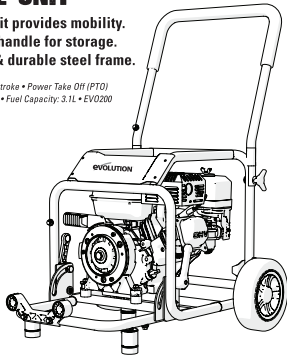

**EVO-SYSTEM ENGINE**

## WATER PUMP

- ✓ Pumps 1000L per minute.
- ✓ Inlet filter prevents unwanted debris from entering the pump.

• Use With: 3" (75mm) Hose • Suction Height: 8m  
• Pump Lift: 28m • DWP1000

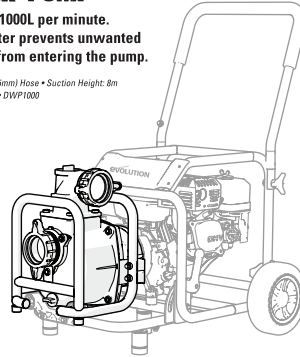

**WATER PUMP OUTPUT**

## PRESSURE WASHER

- ✓ High quality brass pump.
- ✓ Includes lance with adjustable nozzle & hose.
- ✓ Built-in detergent system.

• Max. Flow Rate: 8L/min • Rated Pressure: 175bar  
• Max. Pressure: 220bar • PW5200

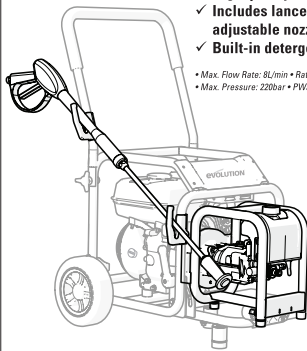

**PRESSURE WASHER OUTPUT**

## GENERATOR

- ✓ Switchable voltages.
- ✓ Thermal cut-outs.
- ✓ Automatic voltage regulation.

• Power: 2400W (Continuous) • AC Output  
• Sockets: 1 x 110V & 1 x 230V • GEN200

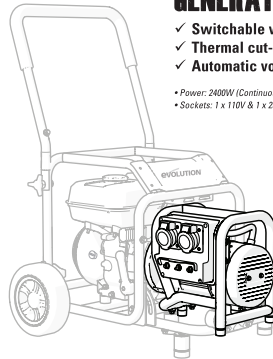

**GENERATOR OUTPUT**



Registered Design, Patent Pending 1101605.2.

# ...WITH MORE OUTPUTS AVAILABLE SOON!