

Erbauer®



ERB373RSP

2Year
Guarantee

1100W RECIPROCATING SAW

Original Instructions
(Version 2.0)

Erbauer®

Congratulations on your purchase of a quality power tool from Erbauer (UK) Ltd. This product should give you reliable service but for your peace of mind this Erbauer power tool does carry a 2 year guarantee, the terms of which are detailed below.

If this product develops a fault within the guarantee period contact your retailer.

Please retain this handbook in case you need to refer to safety, care or guarantee information in the future.

GUARANTEE

This **Erbauer** product carries a 2 year guarantee. If your product develops a fault within this period, you should in the first instance contact the retailer where the item was purchased.

This guarantee specifically excludes losses caused due to:

- Fair wear and tear
- Misuse or abuse
- Lack of routine maintenance
- Failure of consumable items (such as batteries)
- Accidental damage
- Cosmetic damage
- Failure to follow manufacturer's guidelines
- Loss of use of the goods

This guarantee does not affect your statutory rights. This guarantee is only valid in the UK.

For further technical advice, spare parts or repair service (outside of guarantee) please contact the customer helpline number on 0345 607 6380.

1100W RECIPROCATING SAW

GENERAL POWER TOOL SAFETY WARNINGS

 **Warning: Read all safety warnings and all instructions.** Failure to follow the warnings and instructions may result in electric shock, fire and/or serious injury.

Save all warnings and instructions for future reference.

The term “power tool” in the warnings refers to your electric (corded) power tool or battery-operated (cordless) power tool.

1. Work area safety

a. Keep work area clean and well lit. Cluttered or dark areas invite accidents.

b. Do not operate power tools in explosive atmospheres, such as in the presence of flammable liquids, gases or dust. Power tools create sparks which may ignite the dust or fumes.

c. Keep children and bystanders away while operating a power tool. Distractions can cause you to lose control.

2. Electrical safety

a. Power tool plugs must match the outlet. Never modify the plug in any way. Do not use any adapter plugs with earthed (grounded) power tools. Unmodified plugs and matching outlets will reduce risk of electric shock.

b. Avoid body contact with earthed or grounded surfaces, such as pipes, radiators, ranges and refrigerators. There is an increased risk of electric shock if your body is earthed or grounded.

c. Do not expose power tools to rain or wet conditions. Water entering a power tool will increase the risk of electric shock.

d. Do not abuse the cord. Never use the cord for carrying, pulling or unplugging the power tool. Keep cord away from heat, oil, sharp edges or moving parts.

Damaged or entangled cords increase the risk of electric shock.

e. When operating a power tool outdoors, use an extension cord suitable for outdoor use. Use of a cord suitable for outdoor use reduces the risk of electric shock.

f. If operating a power tool in a damp location is unavoidable, use a residual current device (RCD) protected supply. Use of an RCD reduces the risk of electric shock.

3. Personal safety

a. Stay alert, watch what you are doing and use common sense when operating a power tool. Do not use a power tool while you are tired or under the influence of drugs, alcohol or medication. A moment of inattention while operating power tools may result in serious personal injury.

b. Use personal protective equipment. Always wear eye protection. Protective equipment such as dust mask, non-skid safety shoes, hard hat, or hearing protection used for appropriate conditions will reduce personal injuries.

c. Prevent unintentional starting. Ensure the switch is in the off-position before connecting to power source and/or battery pack, picking up or carrying the tool. Carrying power tools with your finger on the switch or energising power tools that have the switch on invites accidents.

d. Remove any adjusting key or wrench before turning the power tool on.

A wrench or a key left attached to a rotating part of the power tool may result in personal injury.

e. Do not overreach. Keep proper footing and balance at all times. This enables better control of the power tool in unexpected situations.

f. Dress properly. Do not wear loose clothing or jewellery. Keep your hair, clothing and gloves away from moving parts. Loose clothes, jewellery or long hair can be caught in moving parts.

g. If devices are provided for the connection of dust extraction and collection facilities, ensure these are connected and properly used. Use of dust collection can reduce dust-related hazards.

4. Power tool use and care

a. Do not force the power tool. Use the correct power tool for your application.

The correct power tool will do the job better and safer at the rate for which it was designed.

b. Do not use the power tool if the switch does not turn it on and off. Any power tool that cannot be controlled with the switch is dangerous and must be repaired.

c. Disconnect the plug from the power source and/or the battery pack from the power tool before making any adjustments, changing accessories, or storing power tools. Such preventive safety measures reduce the risk of starting the power tool accidentally.

d. Store idle power tools out of the reach of children and do not allow persons unfamiliar with the power tool or these instructions to operate the power tool.

Power tools are dangerous in the hands of untrained users.

e. Maintain power tools. Check for misalignment or binding of moving parts, breakage of parts and any other condition that may affect the power tool's operation. If damaged, have the power tool repaired before use. Many accidents are caused by poorly maintained power tools.

f. Keep cutting tools sharp and clean. Properly maintained cutting tools with sharp cutting edges are less likely to bind and are easier to control.

g. Use the power tool, accessories and tool bits etc. in accordance with these instructions, taking into account the working conditions and the work to be performed. Use of the power tool for operations different from those intended could result in a hazardous situation.

5. Service

a. Have your power tool serviced by a qualified repair person using only identical replacement parts. This will ensure that the safety of the power tool is maintained.

b. If the replacement of the supply cord is necessary, this has to be done by the manufacturer or his agent in order to avoid a safety hazard.

ADDITIONAL SAFETY RULES FOR YOUR RECIPROCATING SAW / JIG SAW

- 1. Always wear a dust mask.**
- 2. Hold power tool by insulated gripping surfaces, when performing an operation where the cutting accessory may contact hidden wiring or its own cord.** Cutting accessory contacting a "live" wire may make exposed metal parts of the power tool "live" and could give the operator an electric shock.
- 3. Use clamps or another practical way to secure and support the workpiece to a stable platform.** Holding the work by hand or against your body leaves it unstable and may lead to loss of control.
- 4. Always wear safety glasses or eye shields when using the reciprocating saw.**

1100W RECIPROCATING SAW

Everyday eyeglasses have only impact-resistant lenses; they are NOT safety glasses. Following this rule will reduce the risk of serious personal injury.

5. **Always wear hearing protection during extended periods of operation.** Following this rule will reduce the risk of serious personal injury.
6. **Keep your hands away from cutting area.** Do not reach under the material being cut because the nearness of the blade to your hand is hidden from your sight.
7. **Do not use dull or damaged blades.** Bent blades can break easily, or cause kickback.
8. Remove the plug from the socket before carrying out any adjustment, servicing or maintenance.
9. Fully unwind cable drum extensions to avoid potential overheating.
10. When an extension cable is required you must ensure it has the correct ampere rating for your power tool and is in a safe electrical condition.
11. Ensure your mains supply voltage is the same as indicated on the rating plate.
12. Your tool is double insulated for additional protection against a possible electrical insulation failure within the tool.☐
13. Always check walls, floors and ceilings to avoid hidden power cables and pipes.
14. After long working period, external metal parts and accessories could be hot.
15. Only withdraw the blade from the cut when the blade has been stopped moving.
16. The pivoting blade foot must be held firmly against the material being cut to reduce saw vibration, blade jumping and blade breakage.
17. Before cutting, check the cutting line is free of nails, screws, etc.
18. If possible, ensure the work-piece is firmly clamped to prevent movement.
19. Never stop the cutting blade by applying side pressure to the blade.

 **Warning: Some dust particles created by power sanding, sawing, grinding, drill and other construction jobs contain chemicals known to cause cancer, birth defects or other reproductive harm.** Some examples of these chemicals are:

- Lead from lead-based paints.
- Crystalline silica from bricks and cement and other masonry products.
- Arsenic and chromium from chemically treated timber.

Your risk from these exposures varies, depending upon how often you do this type of work. To reduce your exposure to these chemicals:

- Work in a well-ventilated area.
- Work with approved safety equipment, such as those dust masks that are specially designed to filter microscopic particles.

VIBRATION

The European Physical Agents (Vibration) Directive has been brought in to help reduce hand arm vibration syndrome injuries to power tool users. The directive requires power tool manufacturers and suppliers to provide indicative vibration test results to enable users to make informed decisions as to the period of time a power tool can be used safely on a daily basis and the choice of tool.

Further Advice can be found at www.hse.gov.uk

Vibration total values (triax vector sum) determined according to EN 60745:	
Cutting into wood	Vibration emission value $a_{h\ CW} = 15.26\text{ m/s}^2$
	Uncertainty $K = 1.5\text{ m/s}^2$
Cutting into metal	Vibration emission value $a_{h\ cm} = 10.92\text{ m/s}^2$
	Uncertainty $K = 1.5\text{ m/s}^2$

The declared vibration emission value should be used as a minimum level and should be used with the current guidance on vibration.

Calculating the actual period of the actual period off use can be difficult and the HSE website has further information.

The declared vibration emission been measured in accordance with a standardised test stated above and may be used to compare one tool with another tool.

The declared vibration emission value may also be used in a preliminary assessment of exposure.

 **Warning:** The vibration emission value during actual use of the power tool can differ from the declared value depending on the ways in which the tool is used dependant on the following examples and other variations on how the tool is used:

How the tool is used and the materials being cut or drilled.

The tool being in good condition and well maintained

The use the correct accessory for the tool and ensuring it is sharp and in good condition.

The tightness of the grip on the handles.

And the tool is being used as intended by its design and these instructions.

While working with this power tool, hand/arm vibrations occur. Adopt the correct working practices in order to reduce the exposure to vibration.

This tool may cause hand-arm vibration syndrome if its use is not adequately managed.

 **Warning:** identify safety measures to protect the operator that are based on an estimation of exposure in the actual conditions of use (taking account of all parts of the operating cycle such as the times when the tool is switched off and when it is running idle in addition to the trigger time).Note The use of other tools will reduce the users' total working period on this tool.

Helping to minimise your vibration exposure risk.

1100W RECIPROCATING SAW

ALWAYS use sharp chisels, drills and blades

Maintain this tool in accordance with these instructions and keep well lubricated (where appropriate)

Avoid using tools in temperatures of 10°C or less

Plan your work schedule to spread any high vibration tool use across a number of days.

Health Surveillance

All employees should be part of an employer's health surveillance scheme to help identify any vibration related diseases at an early stage, prevent disease progression and help employees stay in work.

Double insulation

The tool is double insulated. This means that all the external metal parts are electrically insulated from the mains power supply. This is done by placing insulation barriers between the electrical and mechanical components making it unnecessary for the tool to be earthed.

Important note

Be sure the supply is the same as the voltage given on the rating plate. The tool is fitted with a two-core cable and plug.

Remove the mains plug from socket before carrying out, any adjustment or servicing.

SYMBOLS



To reduce the risk of injury, user must read instruction manual



Warning



Double insulation



Wear ear protection



Wear eye protection



Wear dust mask



Waste electrical products should not be disposed of with household waste.
Please recycle where facilities exist. Check with your Local Authority
or retailer for recycling advice.

yyWxx Manufacturing date code; Year of manufacturing (20yy) and week of manufacturing (Wxx);

1100W RECIPROCATING SAW

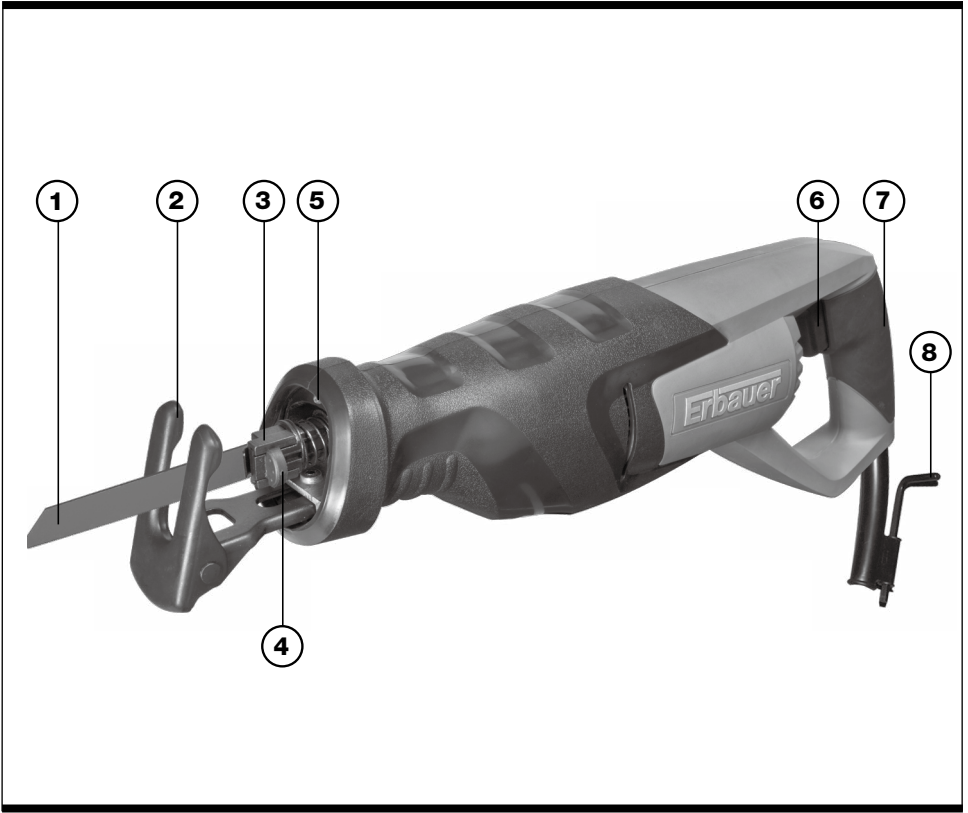

-
1. BLADE

 2. PIVOTING BLADE FOOT

 3. SAW BLADE HOLDER

 4. TOOL-FREE BLADE CLAMP BUTTON

 5. LED LIGHT

 6. ON/OFF SWITCH

 7. HAND GRIP AREAS

 8. HEX KEY
-

TECHNICAL DATA

Rated voltage	230-240V~50Hz
Power input	1100W
Rated no-load speed	0-2700/min
Stroke length	28mm
Cutting capacity max.	
Wood	300mm
Protection class	
Machine weight	3.5kg

NOISE INFORMATION

A weighted sound pressure:	L_{PA} : 88.5 dB (A)	K_{PA} =3.0 dB (A)
A weighted sound power:	L_{WA} : 99.5 dB (A)	K_{WA} =3.0 dB (A)
Wear ear protection when sound pressure is over	80dB(A)	



ACCESSORIES

Blade for metal	1pc
Blade for wood	1pc
Blade for aluminium	1pc
Hex key	1pc

1100W RECIPROCATING SAW

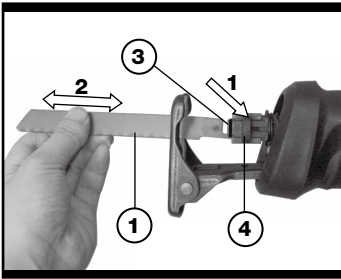

Fig. 1

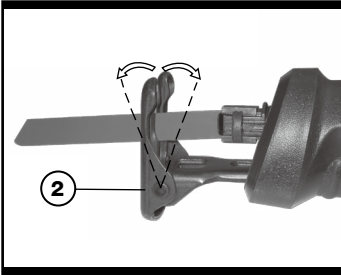

Fig. 2

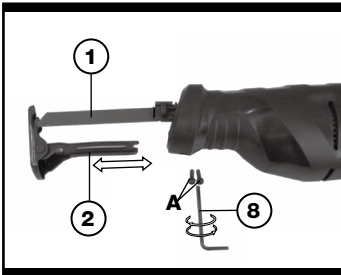

Fig. 3

OPERATING INSTRUCTIONS



Note: Before using the tool, read the instruction book carefully.

Intended Use

The machine is intended for sawing wood, plastic, metal and building materials while resting firmly on the workpiece. It is suitable for straight and curved cuts.

ASSEMBLY

Replacing / Inserting the saw blade (see Fig.1)



Remove the plug from the socket before carrying out any adjustment, servicing or maintenance.

When mounting the saw blade, wear protective gloves. Danger of injury when touching the saw blade. When changing the saw blade, take care that the saw blade holder is free of material residue, e. g. wood or metal shavings.

1. SELECTING A SAW BLADE

Use only saw blades with single-nose shank. The saw blade should not be longer than required for the intended cut. Use a thin saw blade for narrow curve cuts.

2. INSERTING A SAW BLADE

Press the tool-free blade clamp lever (4) and hold. Insert the blade into the saw's blade clamp and make sure that the blade attaches to the blade pin inside the clamp. Push down blade clamp lever (4) ensure the blade is locked securely in place.



Check the tight seating of the saw blade. A loose saw blade can fall out and lead to injuries. For certain work, the saw blade (1) can also be turned through 180° (with the teeth pointed upwards) and reinserted again.

3. REMOVING A SAW BLADE

Rotate the tool-free blade clamp lever (4) in clockwise direction and hold. Pull the blade out of the blade holder and release the clamp lever (4).

OPERATION

1. PIVOTING BLADE FOOT (See Fig.2 , 3)

Due to its movability, the adjustable pivoting blade foot (2) adapts to the required angular position of the surface. It must be held firmly against the material

being cut to reduce saw vibration, blade jumping and blade breakage. (See Fig.2)

If you need to reduce the cutting capacity of your tool (depth of cut), the pivoting foot plate (2) may be adjusted as follows. Loosen the two securing screws (A) on the underside of the front housing with the spanner (8) provided. Slide the pivoting blade foot (2) to the required position. Tighten both screws (A) and check that the blade foot (2) is firmly latched. (see Fig.3)

2. SWITCHING ON AND OFF

Depress the On/Off switch to start and release it to stop your tool.

3. CONTROLLING THE STROKE RATE

Increasing or reducing the pressure on the On/Off switch (6) enables stepless stroke-rate control of the switched-on machine.

The required stroke rate is dependent on the material and the working conditions and can be determined by a practical trial.

Reducing the stroke rate is recommended when the saw blade engages in the material as well as when sawing plastic and aluminium.

4. CUTTING INSTRUCTION

Plunge cutting (see Fig.4)

⚠ The plunge cutting procedure is only suitable for treating soft materials such as wood, plaster board or similar! Do not work metal materials with the plunge cutting procedure!

Use only short saw blades for plunge cutting.

Place the machine with the edge of the blade foot (2) onto the workpiece and switch on. For power tools with stroke speed control, set the maximum stroke speed. Press the power tool firmly against the workpiece and allow the saw blade to slowly plunge into the workpiece.

As soon as the blade foot (2) fully lays on the surface of the workpiece, continue sawing alongside the desired cutting line. For certain work, the saw blade (1) can also be inserted turned through by 180° and the sabre saw can be guided accordingly in a reversed manner.

Flush cutting (See Fig.5)

Pay attention that the saw blade always extends beyond the diameter of the material being worked. There is danger of kickback.

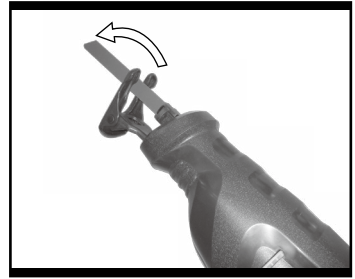

Fig. 4

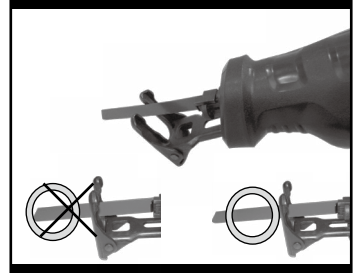

Fig. 5

It is possible to make cuts extremely close to floors, walls and other difficult areas. Insert the blade shank into the blade clamp with the blade teeth facing up (opposite to normal working position). This will make cuts closer to the work surface. Using special flexible blades insert the blade into the blade clamp with the blade teeth facing down (normal working position). It will allow flush pipe cutting.

WOOD CUTTING

For easier control use low speed to start cutting, then increase to the correct speed.

METAL CUTTING

This saw has different metal cutting capacities depending upon the type of blade being used and metal being cut.

Use a finer blade for ferrous metals and a coarse blade for non-ferrous metals.

When cutting thin gauge sheet metals, **ALWAYS** clamp wood on both sides of the sheet. This will give you a clean cut without excess vibration or tearing of the metal.

DO NOT force the cutting blade. Forcing the blade will reduce blade life and cause the blade to break.

Note: We recommend that you spread a thin film of oil or other coolant along the line of cut ahead of the saw. This will allow easier operation and help extend blade life. When cutting aluminum, use kerosene.

WORK HINTS FOR YOUR RECIPROCATING SAW

If your power tool becomes too hot, set the speed to maximum and run a no load for 2-3 minutes to cool the motor.

Always ensure the work-piece is firmly held or clamped to prevent movement.

The blade guard must be held firmly against the material being cut to reduce saw vibration, blade jumping and blade breakage.

MAINTENANCE

Remove the plug from the socket before carrying out any adjustment, servicing or maintenance.

There are no user serviceable parts in your power tool. Never use water or chemical cleaners to clean your power tool. Wipe clean with a dry cloth. Always store your power tool in a dry place. Keep the motor ventilation slots clean. Keep all working controls free of dust. Occasionally you may see sparks through the ventilation slots. This is normal and will not damage your power tool.

If the supply cord is damaged, it must be replaced by the manufacturer, its service agent or similarly qualified persons in order to avoid a hazard.

ENVIRONMENTAL PROTECTION



Waste electrical products should not be disposed of with household waste. Please recycle where facilities exist. Check with your Local Authority or retailer for recycling advice. For further information visit www.recycle-more.co.uk.

1100W RECIPROCATING SAW

PLUG REPLACEMENT (UK & IRELAND ONLY)

If you need to replace the fitted plug then follow the instructions below.

IMPORTANT

The wires in the mains lead are colored in accordance with the following code:

BLUE = NEUTRAL

Brown = Live

As the colors of the wires in the mains lead of this appliance may not correspond with the colored markings identifying the terminals in your plug, proceed as follows. The wire which is colored blue must be connected to the terminal which is marked with N. The wire which is colored brown must be connected to the terminal which is marked with L.



Warning:

Never connect live or neutral wires to the earth terminal of the plug. **Only fit an approved 13AMP BS1363/A plug and the correct rated fuse.**

Note: If a moulded plug is fitted and has to be removed take great care in disposing of the plug and severed cable, it must be destroyed to prevent engaging into a socket.

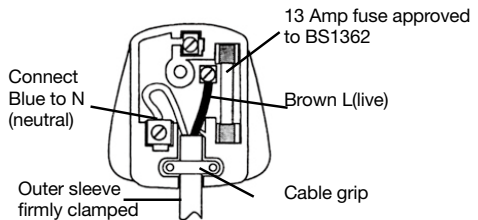

Erbauer®

DECLARATION OF CONFORMITY

We, Importer
Erbauer (UK) Ltd BA22 8RT

Declare that the product
Description: **1100W Reciprocating Saw**
Model: **ERB373RSP**

Complies with the following Directives,
EC Machinery Directive **2006/42/EC**
EC Low Voltage Directive **2006/95/EC**
EC Electromagnetic Compatibility Directive **2004/108/EC**
Restrictions of the Use of Certain Hazardous Substances in Electrical and Electronic Equipment **2011/65/EU**
Waste Electrical and Electronic Equipment (WEEE) **2012/19/EU**

Standards conform to:

EN 55014-1
EN 55014-2
EN 61000-3-2
EN 61000-3-3
EN 60745-1
EN 60745-2-11

Authorised Signatory and technical file holder

Date: 11/06/14

Signature: P. C. Harries

Name / title: Peter Harries / Quality Manager
Erbauer (UK) Ltd. Trade House, Mead Avenue, BA22 8RT



1100W RECIPROCATING SAW





Erbauer®