



IM65 F16

IM65A F16

IM50 F18



Route de Lyon - BP 104
F-26501 Bourg-lès-Valence Cedex - FRANCE



J

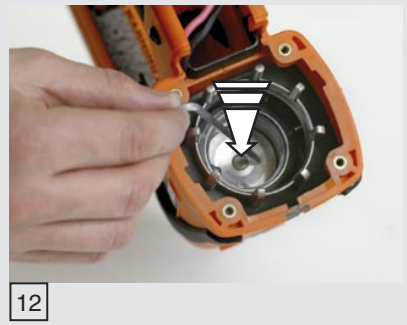
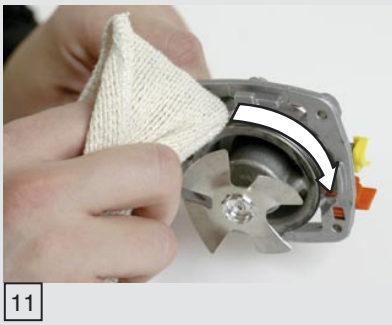
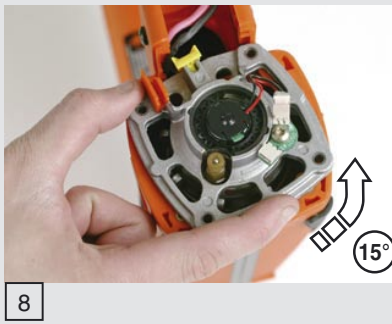
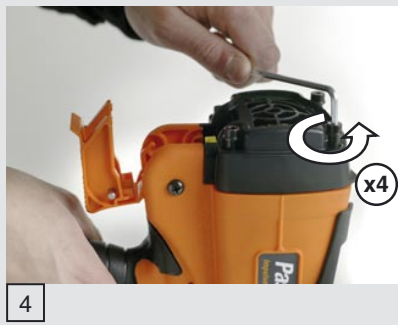
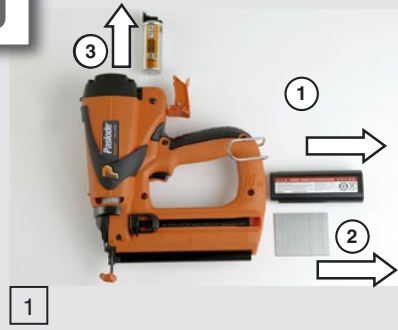



13



14



15

x4



16



17



18

x4



19

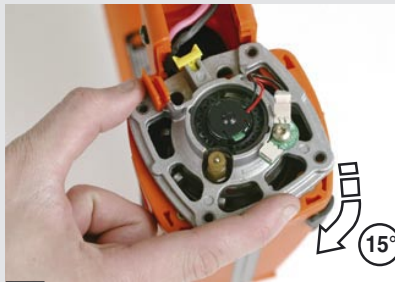

20

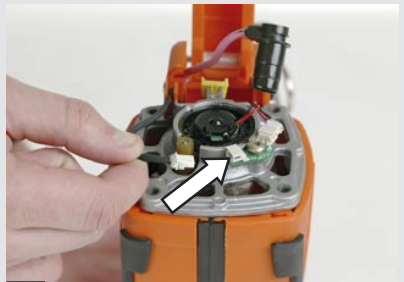

21



22



23



24

x4



25



26

GENERAL SAFETY INSTRUCTIONS FOR THE USE OF INTERNAL COMBUSTION, GAS-OPERATED NAILER TOOLS.

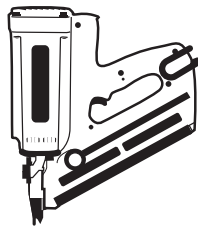

TOOL, GAS CARTRIDGE, BATTERY and BATTERY CHARGER

Thank you for choosing Paslode products. Your tool will provide every satisfaction if you follow the safety instructions and the user manual carefully and if you use only the fasteners, gas cartridges, rechargeable batteries and spare parts recommended by Paslode.

The European Standard EN 792-13 lays down certain safety requirements for non-electric portable nailer tools, and in your own interest we strongly recommend that you follow these safety requirements without exception.



Read all the safety instructions and the instructions in the user manual for the tool, gas cartridge, battery and battery charger carefully.



GENERAL SAFETY INSTRUCTIONS

■ IMPULSE SYSTEM :



■ The IMPULSE system is made up of: the tool, the gas cartridge, the battery and its charger, the set of fasteners. As regards safety, the tool, the fasteners and the gas cartridges referred to in the Paslode documents must be considered as a single, complete system.

Eu ropean standard EN 792-13 : 2000
(§ 7.2.5 a)

■ *Only the fasteners referred to in the operating instructions may be used with the machine.*

■ *Only the lubricants and the main energy source laid down in the operating instructions may be used.*

■ *For the maintenance of the machines, only spare parts specified by the manufacturer or his authorized agent must be used.*



■ Only qualified persons may use the Paslode Impulse nailing system. These persons must know perfectly how the tool works and must follow exactly the manufacturer's instructions and the safety. They must be capable of carrying out the regular servicing on the tool.



■ The tool must be checked before use. It must be loaded only just before it is used. If it is not used, it is essential to remove: the battery, the gas cartridge, the nails remaining in the magazine, and to put it in its original box.

■ When using the tool, never point it at yourself or anyone else. If the operator has to move, the gun must be pointed downwards, taking one's finger off the trigger.

■ The tool must be used in a well-ventilated place. The inhalation of burnt exhaust gas (carbon monoxide) is a danger to health. Keep the tool away from heat sources as the gas cartridge could be damaged.

■ Do not smoke when handling the gas cartridge, Keep the metering valve orifice away from your face and eyes. Do not inhale its contents.

■ Only use the tool for the nailing applications for which it was designed by the manufacturer.

■ At the moment of firing, the operator must be in a stable position, holding the tool as far as possible at right angles to the base material.

■ The operator must ensure that there is no-one in the immediate vicinity of the firing area. Check the work place and environment.

■ If a firing malfunction occurs, keep the tool on the work surface and fire again. If there is another failure, remove the battery immediately and examine the tool. If several incidents occur, inform the manufacturer.

■ When using the tool, the operator and the people around him must wear appropriate individual protection: goggles, safety helmet and ear protectors, etc.

■ Never operate the tool resting on the flat of the hand. The nailer must be operated only when it is in contact with the material to be fixed. For thin parts to be fixed, make sure that the tool is correctly adjusted and position it so that the fastener is aimed towards the base wood.

■ The temperature of the burnt gases and of the tool may increase depending on firing frequency. Observe the use rates given on the data sheets and use gloves to avoid contact with the hot parts of the tool.

■ The condition of the tool must be checked at least once a year by the manufacturer or his authorized agent. We recommend that you carry out regular maintenance (cleaning and greasing) so as to keep the tool in perfect operating condition.

■ It is prohibited to make any modification to the tool, gas cartridge or battery other than those specified by the manufacturer.



■ **GAS CARTRIDGE:**

The gas cartridge is an aerosol product corresponding to the 75/324/EEC and TRG 300 regulations. The cartridge contains:

- liquefied hydrocarbon gases (butane, propane).
- a lubricant for the piston.

The propelling gas remains in the cartridge. The gas cartridge is always pressurized and must be protected from temperatures greater than 50°C. Its contents is extremely flammable.

The gas cartridge is not reusable and refilling is prohibited.

USE:

- Warning : liquid gas can cause injury in the event of contact with the skin or eyes.
- Do not expose to sunlight and to temperatures exceeding 50°C.
- Storage temperature: 5 to 25°C.
- Keep and use the cartridge only in well-ventilated places.
- Do not pierce or burn the cartridge after use.
- Do not spray towards a flame or an incandescent body.
- Keep away from any heat sources and from electrostatic charges.
- Do not smoke.
- Keep away from children.
- Do not breathe the gases.
- Do not refill.
- Dispose of only in designated places.
- For maximum performance, use before the date indicated under the cartridge.

TRANSPORT:

According to the international classification, it is not necessary to have special authorization to transport gas cartridges. Below are the regulations by transport categories:

- Road/rail: ADR – ADR - UN code 1950 class 2 code 5F
- Sea : IMDG – UN code 1950 + risk sheet FD S-U
- Air : IATA – UN code 1950 class 2.1

- **Transport by parcel post is not permitted**
- Transport of small amounts (< 30 Kg) in a private vehicle is permitted without a transport and safety sheet.

STORAGE:

- All local instructions corresponding to fire regulations must be observed.
- Stores and showrooms must comply with building regulations.
- Do not expose to a temperature exceeding 50°C, do not store in passageways and entrance halls and near to doorways.
- Good ventilation is always necessary.
- The cartridge storage area must not exceed 20m².
- The numbers in sale rooms or showrooms must not exceed the numbers sold per day.
- Storage with other pyrotechnic products is not permitted.
- Display units must be away from exits. A class A,B,C 6 kg fire extinguisher must be provided.
- Do not use tools with an incandescent device or which can reach high temperatures near to the cartridges.
- Gas cartridges must not be displayed in shop windows.



■ **BATTERY and BATTERY CHARGER:**



Before using the battery charging system, read the instructions and precautions indicated on the AC/DC adapter, the charger and the battery carefully.

- The charging system is designed to be used in covered places. Do not expose it to rain or to excessive humidity.
- Arrange the charging system so as not to walk on the cable or catch it.
- Do not use the system with a damaged cable or plug. Replace them immediately.
- To avoid electrocution risks, disconnect the power supply adapter before cleaning the terminals and contacts. Use a dry cloth.
- The adapter, the charger and the battery are designed to operate together. Do not use the charging system for other batteries or battery-operated tools.
- Do not put 'Impulse' batteries on charge on chargers other than 'Impulse' chargers.
- Do not short-circuit a battery. A high current could be produced causing overheating and destruction of the battery.
- Do not put a battery on charge if its temperature is less than 5°C or greater than 40°C.
- Do not put metal objects in contact with the battery's terminals.
- Do not pierce or open the battery's cells.
- Do not store batteries at a temperature greater than 50°C.
- Do not incinerate batteries.
- Do not use a battery charger which heats up excessively or gives off fumes when connected. Disconnect the charger immediately.
- Only charge one battery at a time on a charger.
- Batteries must be recycled or taken to appropriate places (collection containers according to local provisions).