

TITAN[®]

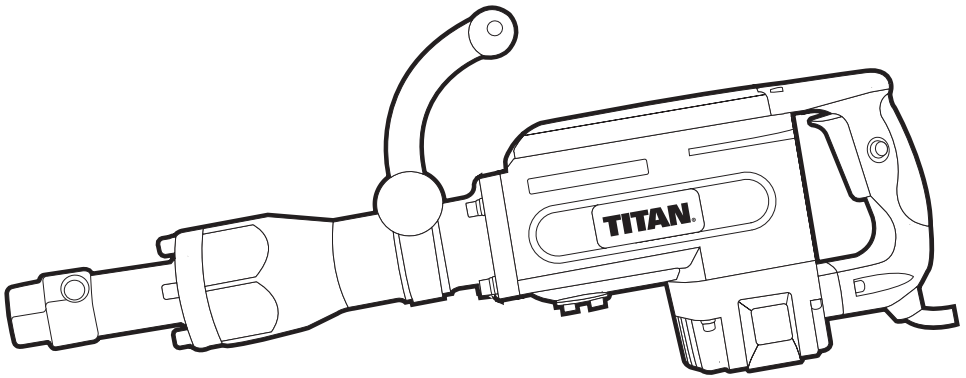

24 **month**
Manufacturer's
Warranty

SAFETY AND OPERATING MANUAL

Original instructions

BREAKER 1700W

TTB280DRH

TITAN®

Congratulations on your purchase of a TITAN power tool from Titan Power Tools (UK) Ltd. We want you to continue getting the best performance from it so this handbook includes information on safety, handling and care. Please retain this handbook in case you need to refer to any of the information in the future.

Your TITAN power tool comes with a 24-month guarantee, so should it develop a fault within this period contact your retailer.

GUARANTEE

This **TITAN** product carries a guarantee of 24 months. If your product develops a fault within this period, you should, in the first instance contact the retailer where the item was purchased.

This guarantee specifically excludes losses caused due to:

- Fair wear and tear
- Misuse or abuse
- Lack of routine maintenance
- Failure of consumable items (such as batteries)
- Accidental damage
- Cosmetic damage
- Failure to follow manufacturer's guidelines
- Loss of use of the goods

This guarantee does not affect your statutory rights. This guarantee is only valid in the UK.

For any enquiries relating to the guarantee please refer to your retailer.

GENERAL SAFETY INSTRUCTIONS



WARNING! Read all safety warnings designated by the symbol  and all instructions.



WARNING! Read all safety warnings and all instructions. Failure to follow the warnings and instructions may result in electric shock, fire and/or serious injury. **Save all warnings and instructions for future reference.**

The term "power tool" in the warnings refers to your mains-operated (corded) power tool or battery-operated (cordless) power tool.

1. Work area safety

- a. Keep work area clean and well lit.** Cluttered or dark areas invite accidents.
- b. Do not operate power tools in explosive atmospheres, such as in the presence of flammable liquids, gases or dust.** Power tools create sparks which may ignite the dust or fumes.
- c. Keep children and bystanders away while operating a power tool.** Distractions can cause you to lose control.

2. Electrical safety

- a. Power tool plugs must match the outlet. Never modify the plug in any way. Do not use any adapter plugs with earthed (grounded) power tools.** Unmodified plugs and matching outlets will reduce risk of electric shock.
- b. Avoid body contact with earthed or grounded surfaces, such as pipes, radiators, ranges and refrigerators.** There is an increased risk of electric shock if your body is earthed or grounded.
- c. Do not expose power tools to rain or wet conditions.** Water entering a power tool will increase the risk of electric shock.
- d. Do not abuse the cord. Never use the cord for carrying, pulling or unplugging the power tool. Keep cord away from heat, oil, sharp edges or moving parts.** Damaged or entangled cords increase the risk of electric shock.
- e. When operating a power tool outdoors, use an extension cord suitable for outdoor use.** Use of a cord suitable for outdoor use reduces the risk of electric shock.
- f. If operating a power tool in a damp location is unavoidable, use a residual current device (RCD) protected supply.** Use of an RCD reduces the risk of electric shock.

3. Personal safety

- a. Stay alert, watch what you are doing and use common sense when operating a power tool. Do not use a power tool while you are tired or under the influence of drugs, alcohol or medication.** A moment of inattention while operating power tools may result in serious personal injury.
- b. Use personal protective equipment. Always wear eye protection.** Protective equipment such as dust mask, non-skid safety shoes, hard hat, or hearing protection used for appropriate conditions will reduce personal injuries.
- c. Prevent unintentional starting. Ensure the switch is in the off-position before connecting to power source and/or battery pack, picking up or carrying the tool.** Carrying power tools with your finger on the switch or energising power tools that have the switch on invites accidents.

BREAKER 1700W

TTB280DRH

d. Remove any adjusting key or wrench before turning the power tool on. A wrench or a key left attached to a rotating part of the power tool may result in personal injury.

e. Do not overreach. Keep proper footing and balance at all times. This enables better control of the power tool in unexpected situations.

f. Dress properly. Do not wear loose clothing or jewellery. Keep your hair, clothing and gloves away from moving parts. Loose clothes, jewellery or long hair can be caught in moving parts.

g. If devices are provided for the connection of dust extraction and collection facilities, ensure these are connected and properly used. Use of dust collection can reduce dust-related hazards.

4. Power tool use and care

a. Do not force the power tool. Use the correct power tool for your application. The correct power tool will do the job better and safer at the rate for which it was designed.

b. Do not use the power tool if the switch does not turn it on and off. Any power tool that cannot be controlled with the switch is dangerous and must be repaired.

c. Disconnect the plug from the power source and/or the battery pack from the power tool before making any adjustments, changing accessories, or storing power tools. Such preventive safety measures reduce the risk of starting the power tool accidentally.

d. Store idle power tools out of the reach of children and do not allow persons unfamiliar with the power tool or these instructions to operate the power tool. Power tools are dangerous in the hands of untrained users.

e. Maintain power tools. Check for misalignment or binding of moving parts, breakage of parts and any other condition that may affect the power tool's operation. If damaged, have the power tool repaired before use. Many accidents are caused by poorly maintained power tools.

f. Keep cutting tools sharp and clean. Properly maintained cutting tools with sharp cutting edges are less likely to bind and are easier to control.

g. Use the power tool, accessories and tool bits etc. in accordance with these instructions, taking into account the working conditions and the work to be performed. Use of the power tool for operations different from those intended could result in a hazardous situation.

5. Service

a. Have your power tool serviced by a qualified repair person using only identical replacement parts. This will ensure that the safety of the power tool is maintained.

ADDITIONAL SAFETY INSTRUCTIONS FOR YOUR BREAKER

This is a powerful concrete breaker. Caution needs to be observed when operating.

1. Always wear ear protectors. Exposure to noise can cause hearing loss.
2. Always wear a dust mask. A lot of dust will be created by the actions.
3. Use auxiliary handles supplied with the tool. Loss of control can cause personal injury.
4. Hold power tool by insulated gripping surfaces, when performing an operation where the cutting accessory may contact hidden wiring or its own cord. Cutting accessory contacting a "live" wire may make exposed metal parts of the power tool "live" and could give the operator an electric shock.
5. Safety boots are recommended at all times especially when using the chisel actions.
6. Always wear proper safety gloves.
7. Dress in suitable overalls.
8. Do not use damaged or worn chisel bits.
9. Do not run the machine with any part of the casing missing or damaged.
10. Use a line detector to localize lines in walls with concealed electric, water or gas lines. Avoid touching live components or conductors.
11. Always pay attention that chisel bits may be flung out of the machine accidentally and cause serious injury.
12. Before starting to work, always check that the chisel or drill bit is properly locked in the chuck.
13. Vibrations can injure the hand-arm system. Keep exposure to vibrations as short as possible.
14. When carrying out work, always hold the tool with both hands and ensure that you have a stable standing position.

HEALTH ADVICE



WARNING! When drilling, sanding, sawing or grinding, dust particles will be produced. In some instances, depending on the materials you are working with, this dust can be particularly harmful to you (e.g. lead from old gloss paint).

You are advised to consider the risks associated with the materials you are working with and to reduce the risk of exposure. You should:

- Work in a well-ventilated area.
- Work with approved safety equipment, such as those dust masks that are specially designed to filter microscopic particles.

VIBRATION

The European Physical Agents (Vibration) Directive has been brought in to help reduce hand arm vibration syndrome injuries to power tool users. The directive requires power tool manufacturers and suppliers to provide indicative vibration test results to enable users to make informed decisions as to the period of time a power tool can be used safely on a daily basis and the choice of tool.

Further Advice can be found at www.hse.gov.uk

Vibration total values (triax vector sum) determined according to EN 60745:	
Chiselling	Vibration emission value $a_{h, cheq} = 22.78\text{m/s}^2$ (with main handle)
	Vibration emission value $a_{h, cheq} = 12.6\text{m/s}^2$ (with auxiliary handle)
	Uncertainty $K = 1.5\text{m/s}^2$

The declared vibration emission value should be used as a minimum level and should be used with the current guidance on vibration.

Calculating the actual period of the actual period off use can be difficult and the HSE website has further information.

The declared vibration emission been measured in accordance with a standardised test stated above and may be used to compare one tool with another.

The declared vibration emission value may also be used in a preliminary assessment of exposure.



Warning: The vibration emission value during actual use of the power tool can differ from the declared value depending on the ways in which the tool is used dependant on the following examples and other variations on how the tool is used:

How the tool is used and the materials being chiselled.

The tool being in good condition and well maintained

The use the correct accessory for the tool and ensuring it is sharp and in good condition.

The tightness of the grip on the handles.

And the tool is being used as intended by its design and these instructions.

This tool may cause hand-arm vibration syndrome if its use is not adequately managed



Warning: identify safety measures to protect the operator that are based on an estimation of exposure in the actual conditions of use (taking account of all parts of the operating cycle such as the times when the tool is switched off and when it is running idle in addition to the trigger time).Note The use of other tools will reduce the users' total working period on this tool.

Helping to minimise your vibration exposure risk.
Maintain this tool in accordance with these instructions and keep well lubricated (where appropriate)

Avoid using tools in temperatures of 10°C or less

Plan your work schedule to spread any high vibration tool use across a number of days.

Health Surveillance

All employees should be part of an employer's health surveillance scheme to help identify any vibration related diseases at an early stage, prevent disease progression and help employees stay in work.

Double insulation: 

The tool is double insulated. This means that all the external metal parts are electrically insulated from the mains power supply. This is done by placing insulation barriers between the electrical and mechanical components making it unnecessary for the tool to be earthed.

Important note:

Be sure the supply is the same as the voltage given on the rating plate. The tool is fitted with a two-core cable and plug.

Remove the mains plug from socket before carrying out any adjustment or servicing.

Due to the power input of this product on start up, voltage drops may occur and this can influence other equipment (e.g. dimming lights). So for technical reasons we advise, if the mains-impedance is $Z_{max} < 0.413 \Omega$, these disturbances are not expected. If you require further clarification, you may contact your local power supply authority.

SYMBOLS



Read the manual



Warning



Waste electrical products should not be disposed of with household waste.
Please recycle where facilities exist. Check with your Local Authority or retailer
for recycling advice.



Wear gloves



Wear ear protection



Wear dust mask



Wear eye protection



Double insulation



Conformity to CE directive

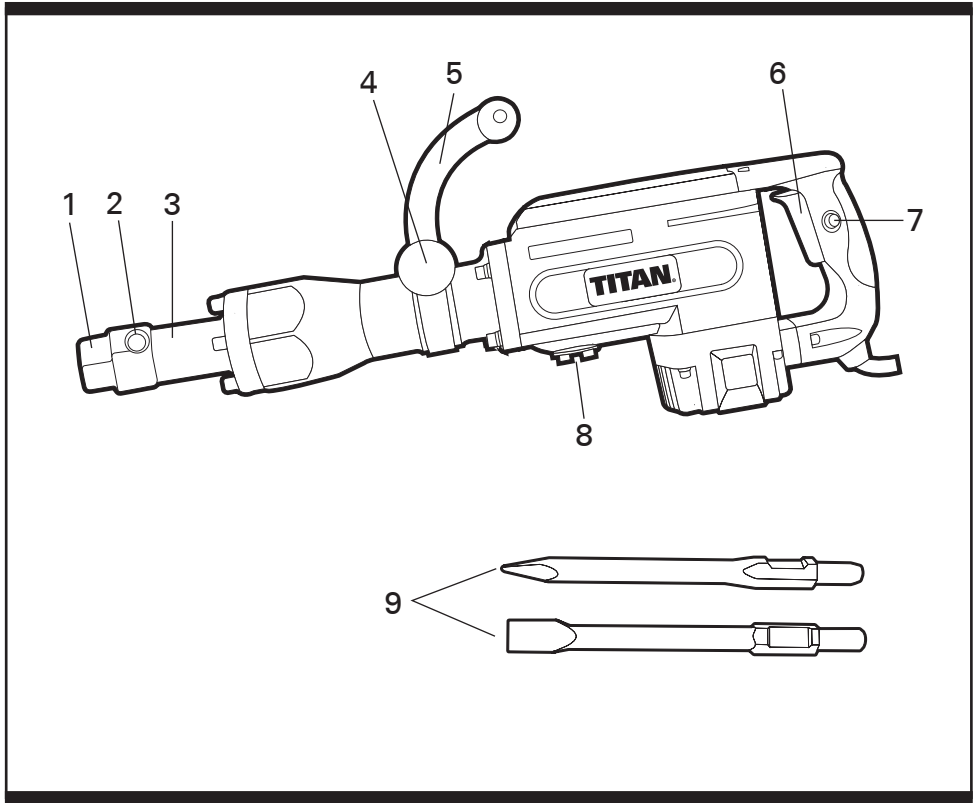

1 Rubber protector

2 Stop lever

3 Front cover

4 Knob

5 Auxiliary Handle

6 ON/OFF Switch

7 Lock-on button

8 Gear box cover

9 Point chisel and Flat chisel

BREAKER 1700W

TTB280DRH

TECHNICAL DATA

Voltage:	230V~ 50Hz
Input power:	1700W
Impact rate:	1300/min
Protection class:	II
Machine weight:	15.5kg

NOISE DATA

A weighted sound pressure	92dB(A) / KpA: 3dB(A)
Guaranteed sound power	105dB(A)
Wear ear protection when sound pressure is over	80dB

ACCESSORIES

Point chisel (For gravel)

1pc

Flat chisel (For crushing asphalt, grooving and squaring)

1pc

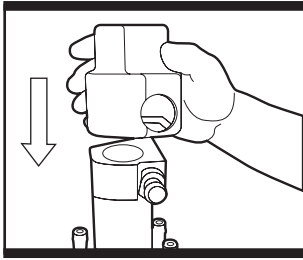

Fig. 1

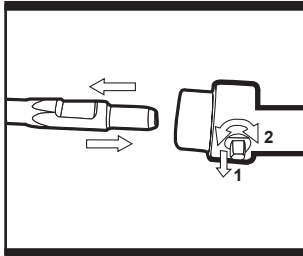

Fig. 2

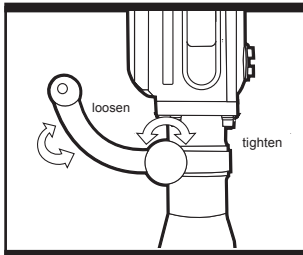

Fig. 3

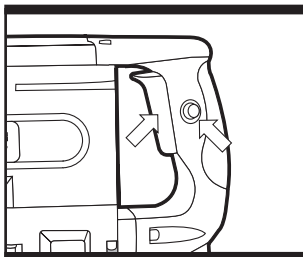

Fig. 4

OPERATIONS INSTRUCTIONS



Note: Before using the tool, read the instruction book carefully.

INTENDED USE

The concrete breaker can be cut crushing asphalt, grooving and squaring, ram tamping sand and gravel, dig ground in various foundation, etc. The machine uses a single phase alternating current 230V, 50Hz motor, its compact and robust format makes it versatile and efficient for uses described in specific safety instructions. It complies to current regulations and the optimum quality of materials used will ensure a long working life in complete safety. This tool is intended for DIY home use, or occasional professional use.

1. RUBBER PROTECTOR (Fig. 1)

Before chiseling vertically fit the rubber protector over the chisel bit.



Caution: Always wear eye protection with this tool.

2. FITTING THE CHISEL (Fig. 2)

1. Insert the chisel into the chuck.
2. Drag the stop lever and rotate it to "Lock" position.

3. REMOVE CHISEL (Fig. 2)

1. Drag the stop lever and rotate it to "Unlock" position.
2. Remove the chisel out of the chuck.

4. FITTING THE AUXILIARY HANDLE (Fig. 3)

Attached the handle as shown in Fig. 3.

5. OPERATING THE LOCK-ON SWITCH

(Fig. 4)

Holding the Breaker with both hands and depress the on/off switch then lock on button in for operation (see Fig. 4). To switch off just depress and release the on/off switch.

6. CHANGE THE CARBON BRUSH

(Fig. 5 & Fig. 6)

Replace when the Carbon brush wear down to length of about 6mm or less.

 **Warning!** These carbon brushes should be replaced by a qualified service engineer. Carbon brush should be replaced in pairs. Remove the covers for carbon brush. (as shown Fig. 5 & Fig. 6)

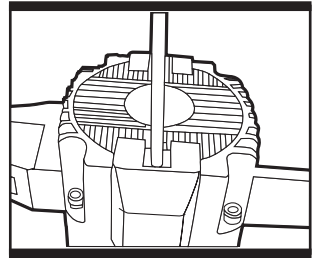

Fig. 5

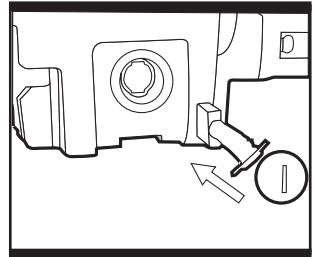

Fig. 6

MAINTENANCE

1. There are no user serviceable parts in your power tool.
2. Never use water or chemical cleaners to clean your power tool. Wipe clean with a dry cloth.
3. Always store your power tool in a dry place.
4. Keep the motor ventilation slots clean.
5. If you see some sparks flashing in the ventilation slots, this is normal and will not damage your power tool.

HANDY HINTS

Always use sharp good quality chisels. The performance of the tool is dependent on the quality of the bits used.

- Reduce the pressure on the chisel bit when it is about to break through.
- Always operate tool using both the handle and the front handle.
- Make sure that you wear safety glasses and protective gloves.
- Do not apply excessive pressure to the tool. Expressive force does not speed up the work.

TROUBLESHOOTING

1. If your breaker do not start, check the plug and fuse on the mains supply first.
2. If your concrete breaker use in low efficiency, please check whether the chisel is blunt.

ENVIRONMENTAL PROTECTION



Waste electrical products should not be disposed of with household waste. Please recycle where facilities exist. Check with your Local Authority or retailer for recycling advice. For further information visit www.recyclemore.co.uk

UK PLUG REPLACEMENT

The fuse in the main plug of your tool should always be replaced with one of identical rating.

Check the voltage given on your tool matches the supply voltage.

The tool is supplied with a fitted plug, however if you should need to fit a new plug follows the instruction below.

IMPORTANT

The wire in the mains lead are coloured in accordance with the following code:

Blue ---Neutral

Brown ---Live

The wire that is coloured **blue** must be connected to the terminal that is marked with the letter **N**. The wire that is coloured **brown** must be connected to the terminal that is marked with the letter **L**.

A 13 AMP (BS1363 or BS1363/A) plug must be used and a 13 AMP fuse must be fitted.

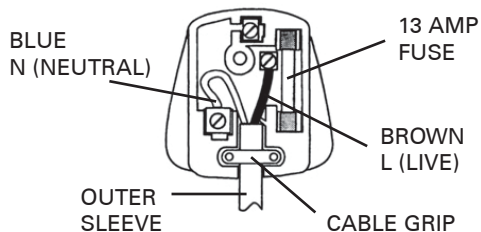

BREAKER 1700W

TTB280DRH

TITAN[®]

Declaration of Conformity

We, Importer
Titan Power Tools (UK) Ltd
Trade house, Mead Avenue, BA22 8RT

Declare that the product:
Designation: BREAKER 1700W
Model: TTB280DRH

Complies with the following Directives:
2004/108/EC Electromagnetic Compatibility Directive,
2006/42/EC Machinery Directive
2006/95/EC Low Voltage Directive,
2002/95/EC Restrictions of the Use of Certain Hazardous Substances in Electrical and Electronic Equipment
2002/96/EC and **2003/108/EC** Waste Electrical and Electronic Equipment (WEEE),

2000/14/EC amended by 2005/88/EC Noise Emission in the Environment by Equipment for Use
Outdoors Directive
- Measured Sound Power Level **103dB(A)**
- Declared Guaranteed Sound Power Level **105dB(A)**

The conformity assessment followed was according to Annex III of the directive for
equipment listed in schedule 1 / article 12 the chosen conformity assessment route
Internal control of production (schedule 10 / Annex V)
Notified body Societe Nationale de Certification et d'Homologation
Notified Body Identification Number: 0499

Standards and technical specifications referred to:
EN60745-1:2009
EN60745-2-6:2003+A1:2006+A11:2007+A2:2009+A12:2009
EN 55014-1: 2006
EN 55014-2:1997+A1: 2001
EN 61000-3-2: 2006
EN 61000-3-11:2000

Authorised signatory and technical file holder

Date: 07/07/2010

Signature: *P. C. Harries*

Name / title: Peter Harries / Quality Manager

Titan Power Tools (UK)Ltd. Trade House , Mead Avenue ,BA22 8RT

