

TITAN®



SAFETY AND OPERATING MANUAL

Original instructions

10.8V DRILL DRIVER

TTP451DDH

TITAN®

Congratulations on your purchase of a TITAN power tool from Titan Power Tools (UK) Ltd. We want you to continue getting the best performance from it so this handbook includes information on safety, handling and care. Please retain this handbook in case you need to refer to any of the information in the future.

Your TITAN power tool comes with a 2 year guarantee, so should it develop a fault within this period contact your retailer.

GUARANTEE

This **TITAN** product carries a guarantee of 2 years. If your product develops a fault within this period, you should, in the first instance contact the retailer where the item was purchased.

This guarantee specifically excludes losses caused due to:

- Fair wear and tear
- Misuse or abuse
- Lack of routine maintenance
- Failure of consumable items (such as batteries)
- Accidental damage
- Cosmetic damage
- Failure to follow manufacturer's guidelines
- Loss of use of the goods

This guarantee does not affect your statutory rights. This guarantee is only valid in the UK.

For any enquiries relating to the guarantee please refer to your retailer.

10.8V DRILL DRIVER

TTP451DDH

GENERAL SAFETY INSTRUCTIONS



WARNING! Read all safety warnings designated by the symbol  and all instructions.



WARNING! Read all safety warnings and all instructions. Failure to follow the warnings and instructions may result in electric shock, fire and/or serious injury. Save all warnings and instructions for future reference. The term "power tool" in the warnings refers to your mains-operated (corded) power tool or battery-operated (cordless) power tool.

1. Work area safety

- a. Keep work area clean and well lit.** Cluttered or dark areas invite accidents.
- b. Do not operate power tools in explosive atmospheres, such as in the presence of flammable liquids, gases or dust.** Power tools create sparks which may ignite the dust or fumes.
- c. Keep children and bystanders away while operating a power tool.** Distractions can cause you to lose control.

2. Electrical safety

- a. Power tool plugs must match the outlet. Never modify the plug in any way. Do not use any adapter plugs with earthed (grounded) power tools.** Unmodified plugs and matching outlets will reduce risk of electric shock.
- b. Avoid body contact with earthed or grounded surfaces, such as pipes, radiators, ranges and refrigerators.** There is an increased risk of electric shock if your body is earthed or grounded.
- c. Do not expose power tools to rain or wet conditions.** Water entering a power tool will increase the risk of electric shock.
- d. Do not abuse the cord. Never use the cord for carrying, pulling or unplugging the power tool. Keep cord away from heat, oil, sharp edges or moving parts.** Damaged or entangled cords increase the risk of electric shock.
- e. When operating a power tool outdoors, use an extension cord suitable for outdoor use.** Use of a cord suitable for outdoor use reduces the risk of electric shock.
- f. If operating a power tool in a damp location is unavoidable, use a residual current device (RCD) protected supply.** Use of an RCD reduces the risk of electric shock.

3. Personal safety

- a. Stay alert, watch what you are doing and use common sense when operating a power tool. Do not use a power tool while you are tired or under the influence of drugs, alcohol or medication.** A moment of inattention while operating power tools may result in serious personal injury.
- b. Use personal protective equipment. Always wear eye protection.** Protective equipment such as dust mask, non-skid safety shoes, hard hat, or hearing protection used for appropriate conditions will reduce personal injuries.
- c. Prevent unintentional starting. Ensure the switch is in the off-position before connecting to power source and/or battery pack, picking up or carrying the tool.** Carrying power tools with your finger on the switch or energising power tools that have the switch on invites accidents.

d. Remove any adjusting key or wrench before turning the power tool on. A wrench or a key left attached to a rotating part of the power tool may result in personal injury.

e. Do not overreach. Keep proper footing and balance at all times. This enables better control of the power tool in unexpected situations.

f. Dress properly. Do not wear loose clothing or jewellery. Keep your hair, clothing and gloves away from moving parts. Loose clothes, jewellery or long hair can be caught in moving parts.

g. If devices are provided for the connection of dust extraction and collection facilities, ensure these are connected and properly used. Use of dust collection can reduce dust-related hazards.

4. Power tool use and care

a. Do not force the power tool. Use the correct power tool for your application. The correct power tool will do the job better and safer at the rate for which it was designed.

b. Do not use the power tool if the switch does not turn it on and off. Any power tool that cannot be controlled with the switch is dangerous and must be repaired.

c. Disconnect the plug from the power source and/or the battery pack from the power tool before making any adjustments, changing accessories, or storing power tools. Such preventive safety measures reduce the risk of starting the power tool accidentally.

d. Store idle power tools out of the reach of children and do not allow persons unfamiliar with the power tool or these instructions to operate the power tool. Power tools are dangerous in the hands of untrained users.

e. Maintain power tools. Check for misalignment or binding of moving parts, breakage of parts and any other condition that may affect the power tool's operation. If damaged, have the power tool repaired before use. Many accidents are caused by poorly maintained power tools.

f. Keep cutting tools sharp and clean. Properly maintained cutting tools with sharp cutting edges are less likely to bind and are easier to control.

g. Use the power tool, accessories and tool bits etc. in accordance with these instructions, taking into account the working conditions and the work to be performed. Use of the power tool for operations different from those intended could result in a hazardous situation.

5. Battery tool use and care

a. Recharge only with the charger specified by the manufacturer.

A charger that is suitable for one type of battery pack may create a risk of fire when used with another battery pack.

b. Use power tools only with specifically designated battery packs.

Use of any other battery packs may create a risk of injury and fire.

c. When battery pack is not in use, keep it away from other metal objects, like paper clips, coins, keys, nails, screws or other small metal objects, that can make a connection from one terminal to another. Shorting the battery terminals together may cause burns or a fire.

d. Under abusive conditions, liquid may be ejected from the battery; avoid contact. If contact accidentally occurs, flush with water. If liquid contacts eyes, additionally seek medical help. Liquid ejected from the battery may cause irritation or burns.

6. Service

a. Have your power tool serviced by a qualified repair person using only identical replacement parts. This will ensure that the safety of the power tool is maintained.

ADDITIONAL SAFETY INSTRUCTIONS FOR YOUR DRILL DRIVER

FOR DRILL

1. Wear ear protection with cordless drill. Exposure to noise can cause hearing loss.
2. Hold tool by insulated gripping surfaces when performing an operation where the drill bit tool may contact hidden wiring. Contact with a 'live' wire will also make exposed metal parts of the tool 'live' and shock the operator.
3. Remove the battery pack from the drill before carrying out adjustments.
4. Do not expose to rain or water.
5. Do not store the battery pack in temperatures over 50°C.
6. Always charge the battery pack between temperatures 0°C to 50°C. Ideal charging temperature is 18°C to 24°C.
7. Only use the charger and the battery pack provided, no other battery is suitable.
8. Avoid short circuit of the battery pack connections (screws & nails).
9. Do not incinerate or burn the battery pack, it may explode.
10. Do not charge a damaged battery pack.
11. Replace any damaged supply cords on your charger, this must be carried out by a suitably qualified person.
12. Always disconnect the charger power supply before making or breaking the connections to the battery pack.
13. Your battery pack and charger will be warm during charging, this is normal.
14. When not in use, remove a charged battery pack from the charger.
15. Always remove the battery pack from the charger immediately after re-charging is completed.
16. Your drill and battery pack will be warm when working, this is normal.
17. Do not dispose of batteries in fire, or with household waste. Return exhausted batteries to your local collection or recycling point.
18. Always check walls, floors and ceilings for hidden power cables and pipes.
19. Accessories and metal parts can become very hot.

FOR CHARGER

1. This appliance is not intended for use by persons (including children) with reduced physical, sensory or mental capabilities, or lack of experience and knowledge, unless they have been given supervision or instruction concerning use of the appliance by a person responsible for their safety. Children should be supervised to ensure that they do not play with the appliance.
2. Charger is double insulated for additional electrical safety.
3. Charger is for indoor use only.
4. If the charger supply cord is damaged, it must be replaced by the manufacturer, its service agent or similarly qualified persons in order to avoid a hazard.
5. Never charge damaged batteries as these can short circuit and over heat.

6. When the charger is in use it **MUST** be supervised , if there is any evidence of overheating then **IMMEDIATELY** disconnect the charger from the power supply.
7. If gas or smoke is emitted from the battery during charging switch off the power supply , and move to a well vented area to allow the fumes to vent to atmosphere.
Caution if there is leaking liquid from the battery wear protective clothing, glasses and clothes as this can be acidic.
8. Always disconnect battery charger and remove battery from charger when the charging is complete.
9. Only use the battery charger and battery stated in this manual.

FOR BATTERY

1. Always remove the battery pack from the charger immediately after re-charging is completed.
2. When not in use, remove a charged battery pack from the charger.
3. Do not charge a damaged battery pack.
4. Do not charge non-rechargeable batteries.
5. Do not install the battery backwards so the polarity is reversed.
6. Do not connect the positive terminal and negative terminal of the battery to each other with any metal object (such as wire).
7. Do not carry or store battery together with necklaces, hairpins or other metal objects which could cause short circuit.
8. Do not pierce the battery with nails, strike the battery with a hammer, step on the battery which could cause short circuit or otherwise subject it to strong impacts or shocks.
9. Do not solder directly onto the battery.
10. Do not expose battery to water or salt water, or allow the battery to get wet.
11. Do not disassemble or modify the battery. The battery contains safety and protection devices, which, if damaged, may cause the battery to generate heat, explode or ignite. The protection circuit module provided with battery packs is not to be used as a substitute for a shut-off switch.
12. Do not place the battery in or near fire, on stoves or other high temperature locations. Do not place the battery in direct sunlight, or use or store the battery inside cars in hot weather. Heating the battery can damage the safety circuitry, which can cause additional heating, rupture or ignition of the battery. Using the battery in this manner may also result in a loss of performance and a shortened life expectancy.
13. Do not place the battery in microwave ovens, high-pressure containers or on induction cookware.
14. If you intend to store a battery for a period without use then store battery at room temperature (19°C to 25°C), charged to about 30 – 50% of capacity. When storing for very long periods boost-charge the battery once per year to prevent over discharge.
15. Always charge the battery in a temperature range of 0°C to 30°C.
16. The battery pack and charger will be warm during charging, this is normal.
17. Do not continue charging the battery if it does not recharge within the specified charging time. Doing so may cause the battery to become hot, explode or ignite. The temperature range over which the battery can be charged is 0°C to 30°C. Charging the battery at temperatures outside this range may cause severe damage to the battery or reduce battery life expectancy.
18. When the battery is worn out, insulate the terminals with adhesive tape or similar materials before disposal.
19. Do not dispose of batteries in fire, or with household waste. Return exhausted batteries to your local collection or recycling point.



WARNING! Some dust particles created by power sanding, sawing, grinding, drilling and other construction jobs contain chemicals known to cause cancer, birth defects or other reproductive harm. Some examples of these chemicals are:

Lead from lead-based paints.

Crystalline silica from bricks and cement and other masonry products.

Arsenic and chromium from chemically treated timber.

Your risk from these exposures varies, depending upon how often you do this type of work. To reduce your exposure to these chemicals:

Work in a well ventilated area.

Work with approved safety equipment, such as those dust masks that specially designed to filter out microscopic particles and use the dust extraction facility at all time.

VIBRATION

The European Physical Agents (Vibration) Directive has been brought in to help reduce hand arm vibration syndrome injuries to power tool users. The directive requires power tool manufacturers and suppliers to provide indicative vibration test results to enable users to make informed decisions as to the period of time a power tool can be used safely on a daily basis and the choice of tool.

Further Advice can be found at www.hse.gov.uk

Vibration total values (triax vector sum) determined according to EN 60745:	
Drilling & Screwdriving	Vibration for drilling into metal $a_{h, D} = 1.189 \text{ m/s}^2$
	Vibration for screwdriving $a_h = 0.742 \text{ m/s}^2$
	Uncertainty $K = 1.5 \text{ m/s}^2$

The declared vibration emission value should be used as a minimum level and should be used with the current guidance on vibration.

Calculating the actual period of the actual period off use can be difficult and the HSE website has further information.

The declared vibration emission been measured in accordance with a standardised test stated above and may be used to compare one tool with another.

The declared vibration emission value may also be used in a preliminary assessment of exposure.



Warning: The vibration emission value during actual use of the power tool can differ from the declared value depending on the ways in which the tool is used dependant on the following examples and other variations on how the tool is used:

How the tool is used and the materials being drilled.

The tool being in good condition and well maintained

The use of the correct accessory for the tool and ensuring it is sharp and in good condition.

The tightness of the grip on the handles.

And the tool is being used as intended by its design and these instructions.

This tool may cause hand-arm vibration syndrome if its use is not adequately managed



Warning: identify safety measures to protect the operator that are based on an estimation of exposure in the actual conditions of use (taking account of all parts of the operating cycle such as the times when the tool is switched off and when it is running idle in addition to the trigger time). Note The use of other tools will reduce the users' total working period on this tool.

Helping to minimise your vibration exposure risk.

Maintain this tool in accordance with these instructions and keep well lubricated (where appropriate)

Avoid using tools in temperatures of 10°C or less.

Plan your work schedule to spread any high vibration tool use across a number of days.

Health Surveillance

All employees should be part of an employer's health surveillance scheme to help identify any vibration related diseases at an early stage, prevent disease progression and help employees stay in work.

Double insulation: 

The charger is double insulated. This means that all the external metal parts are electrically insulated from the mains power supply. This is done by placing insulation barriers between the electrical and mechanical components making it unnecessary for the tool to be earthed.

Important note:

Be sure the supply is the same as the voltage given on the rating plate for the charger. The charger is fitted with a two-core cable and plug.

Remove the mains plug from socket before carrying out any adjustment or servicing.

Vibration and noise reduction

To reduce the impact of noise and vibration emission, limit the time of operation, use low-vibration and low-noise operating modes as well as wear personal protective equipment.

Take the following points into account to minimize the vibration and noise exposure risks:

1. Only use the product as intended by its design and these instructions.
2. Ensure that the product is in good condition and well maintained.
3. Use correct application tools for the product and ensure they in good condition.
4. Keep tight grip on the handles/grip surface.
5. Maintain this product in accordance with these instructions and keep it well lubricated (where appropriate).
6. Plan your work schedule to spread any high vibration tool use across a number of days.

Familiarise yourself with the use of this product by means of this instruction manual. Memorise the safety directions and follow them to the letter.

This will help to prevent risks and hazards.

1. Always be alert when using this product, so that you can recognise and handle risks early. Fast intervention can prevent serious injury and damage to property.
2. Switch off and disconnect from the power supply if there is any malfunction. Have the product checked by a qualified specialist and repaired, if necessary, before you put it into operation again.

Health Surveillance

All employees should be part of an employer's health surveillance scheme to help identify any vibration related diseases at an early stage, prevent disease progression and help employees stay in work.

Residual risks

Even if you are operating this product in accordance with all the safety requirements, potential risks of injury and damage remain. The following dangers can arise in connection with the structure and design of this product:

1. Health defects resulting from vibration emission if the product is being used over long periods of time or not adequately managed and properly maintained.
2. Injuries and damage to property due to broken application tools or the sudden impact of hidden objects during use.
3. Danger of injury and property damage caused by flying objects.



WARNING!

This product produces an electromagnetic field during operation! This field may under some circumstances interfere with active or passive medical implants! To reduce the risk of serious or fatal injury, we recommend persons with medical implants to consult their doctor and the medical implant manufacturer before operating this product!

Important note:

Be sure the supply is the same as the voltage given on the rating plate for the charger. The charger is fitted with a two-core cable and plug.

Remove the mains plug from socket before carrying out any adjustment or servicing.

SYMBOLS



To reduce the risk of injury, user must read instruction manual



Warning



Wear ear protection



Waste electrical products should not be disposed of with household waste.

Please recycle where facilities exist. Check with your Local Authority or retailer for recycling advice.



Li-Ion



Double insulation



Conformity to CE directive



Always charge the battery pack between temperatures 0°C to 50°C



Indoor use only



Do not expose to rain or water



Do not burn



30 min charging time

30min



Before charging, read the instructions



This symbol indicates that this battery contains lithium. This battery shall be recycled.

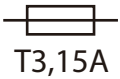

Safety fuse

yyWxx Manufacturing date code: Year of manufacturing (20yy) and week of manufacturing (Wxx);

10.8V DRILL DRIVER

TTP451DDH

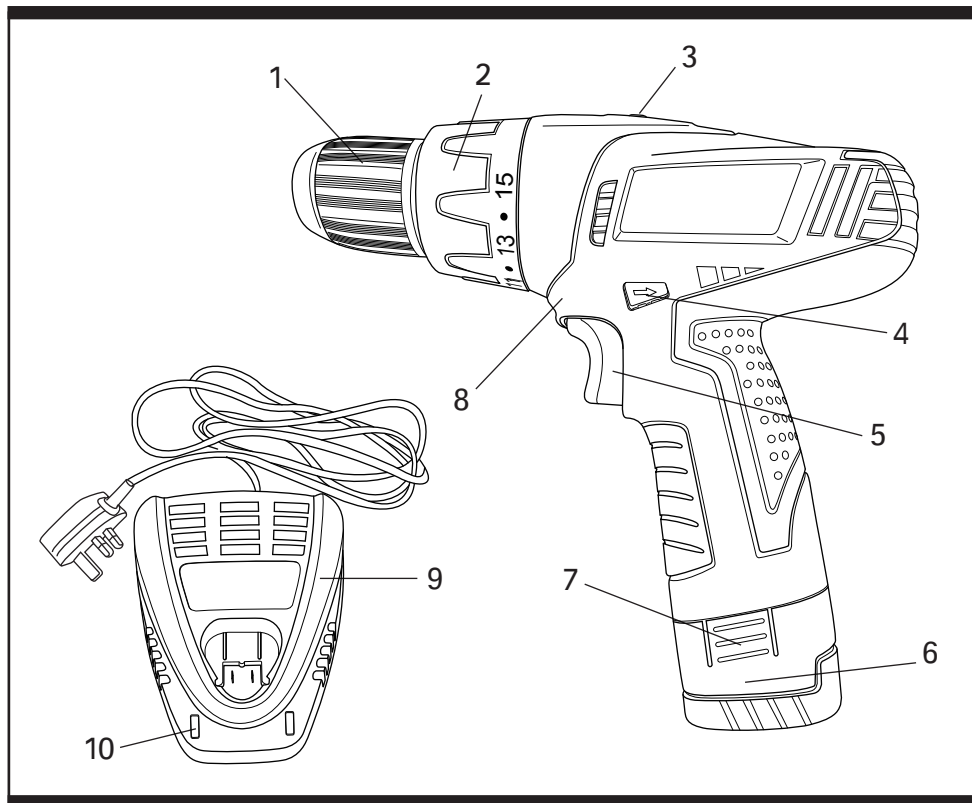

1 Keyless chuck

2 Torque adjustment ring

3 Gear control

4 Forward /lock/ reverse rotation

5 ON/OFF switch with variable speed control

6 Battery pack

7 Battery pack release button

8 LED light

9 Charger

10 Charging indicator

10.8V DRILL DRIVER

TTP451DDH

TECHNICAL DATA

Voltage:	10.8V ---
Speed:	0-400/min / 0-1300/min
Maximum capacity of the chuck:	10mm
Drilling Capacity:	
Wood:	\varnothing 25mm
Steel:	\varnothing 10mm
Machine weight:	1.2 kg
Charger:	
Charger model:	TTB450CHR
Input:	220-240V~ 50Hz 56W
Output:	12V --- 3A
Charging time:	30 min
Charger weight:	0.5kg
Battery:	
Battery model:	TTP449BAT
Battery weight:	0.2kg
	Li-Ion/10.8V/1300mAh 14Wh

NOISE DATA

A weighted sound pressure	65.4dB(A) / K_{PA} : 3dB(A)
A weighted sound power	76.4dB(A) / K_{WA} : 3dB(A)
Wear ear protection when sound pressure is over	80dB

ACCESSORIES

1.5Ah Li-Ion battery pack

1pc

30 minutes charger

1pc

10.8V DRILL DRIVER

TTP451DDH

OPERATIONS INSTRUCTIONS



Note: Before using the tool, read the instruction book carefully.

INTENDED USE

This cordless drill driver shall be used for drilling metal or wood or similar materials and screw driving. Other uses for the tool will lead to the damage of the tool and a series of dangers to the operator. This tool is intended for DIY home use, or occasional professional use.

BEFORE USING YOUR CORDLESS DRILL

Your battery pack is UNCHARGED and you must charge once before use. When you charge the new battery or one which has not been used for long periods of time, it may not reach full charge until after you have discharged it fully in use and recharge it several times.



WARNING: The charger and battery pack are specifically designed to work together so do not attempt to use any other devices. Never insert or allow metallic objects into your charger or battery pack connections because an electrical failure and hazard will occur.

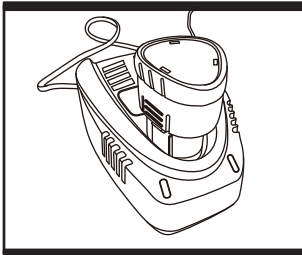

Fig. 1

1. TO CHARGE THE BATTERY PACK (Fig. 1)



Warning: Only use charger TTB450CHR to charge battery TTP449BAT.

Insert the charger plug into a suitable mains socket.

The red light will illuminate. Insert the battery pack into the charger. The red light will still be on and the green light will flash to indicate that charging is taking place. When fully charged, both red light and green light will illuminate.

If the red light flashes during the charging, it means that a breakdown or an error happened.

Unplug the charger and remove the battery pack.



Warning: When battery charge runs out after continuously use or exposure to direct sunlight or heat, allow time for the tool to cool down before re-charging to achieve the full charge.

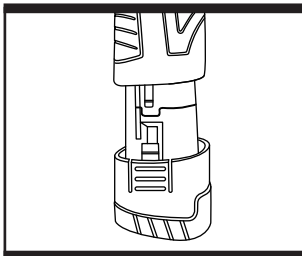

Fig. 2

2. TO REMOVE OR INSTALL BATTERY PACK (Fig. 2)

To remove the battery pack(6) from the tool, firmly press and hold in the battery pack release button(7) and slide the battery pack out of the tool. To install the battery pack, align raised rib on battery pack with groove inside tool, slide the battery pack fully onto the tool until the battery pack “clicks” into position. Make sure the release button on battery pack snaps in place and the battery pack is secured in tool before beginning operation.

OPERATIONS INSTRUCTIONS

1. ON/OFF SWITCH & VARIABLE SPEED CONTROL (Fig. 3)

Depress to start and release to stop your drill. The on/off switch is fitted with a brake function which stops your chuck immediately when you quickly release the switch. This tool has a variable speed control built into the trigger. The variable speed control enables you to select the best speed for a particular job. The further you squeeze the control the faster the drill will operate.

 **Warning:** Do not operate for long periods at low speed because excess heat will be produced internally.

2. FORWARD/REVERSE SWITCH & SWITCH LOCK (Fig. 3)

The switch trigger can be locked in the OFF position. This helps to reduce the possibility of accidental starting when not in use. To lock the switch trigger, place the direction of rotation selector in the centre position.

For drilling and screw driving use forward rotation (lever is moved to the left). Only use reverse rotation (lever is moved to the right) to remove screws or release a jammed drill bit.

 **Warning:** Never change the direction of rotation when the chuck is rotating. Wait until it has stopped.

3. TWO-SPEED GEAR CONTROL (Fig. 4 & 5)

The drill has a two-speed gear control designed for drilling or driving at low (mark is 1) or high (mark is 2) speeds. A slide switch (3) is located on top of the drill to select either low or high speed. When using the drill in the low speed range, the speed will decrease and the drill will have greater power and torque. When using the drill in the high speed range, the speed will increase and the drill will have less power and torque.

 **WARNING:** To prevent gear damage, always allow the chuck to come to a complete stop before changing the direction of rotation or the two-speed gear train.

4. BIT REPLACEMENT

To open the chuck jaws rotate the front section of the chuck. Insert suitable screwdriver bit (or drill bit) between the chuck jaws and rotate the front section in the opposite direction. Ensure the bit is in the centre of the chuck jaws. Finally, firmly rotate the front chuck section in the opposite directions. Your bit is now clamped in the chuck.

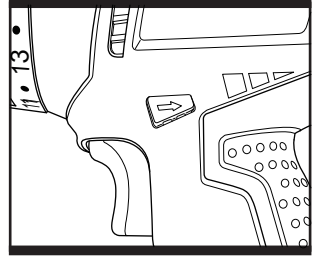

Fig. 3

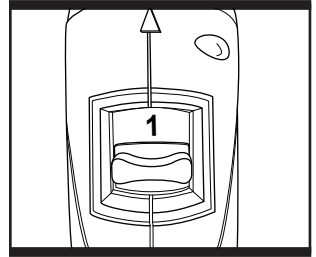

Fig. 4

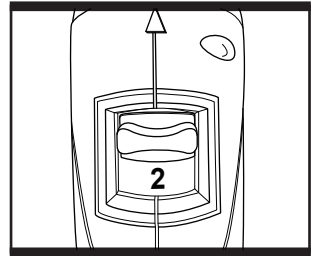

Fig. 5

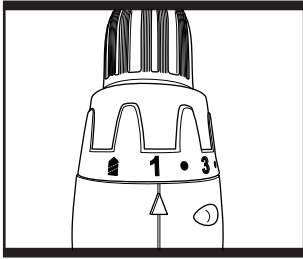

Fig. 6

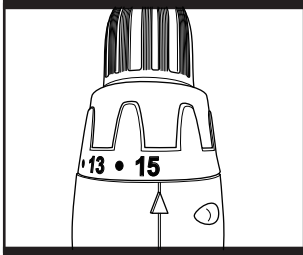

Fig. 7

5. TORQUE ADJUSTMENT (Fig. 6 & 7)

(Screw driving force of your drill driver)

The torque is adjusted by rotating the torque adjustment ring(2). The torque is greater when the torque adjustment ring is set on a higher setting. The torque is less when the torque adjustment ring is set on a lower setting.

Make the setting as follows:

1 low setting, e. g., small screws, soft materials.

15 high setting, e. g., large screws, hard materials.

 for heavy drilling.

6. DRILLING

When drilling hard smooth surfaces, use a centre punch to mark the desired hole location. This will prevent the drill bit from slipping off centre as the hole is started. Hold the tool firmly and place the tip of the bit at the point to be drilled. Depress the switch trigger to start the tool. Move the drill bit into the work-piece, applying only enough pressure to keep the bit drilling. Do not force or apply side pressure to elongate a hole.



WARNING: When drilling in metal, only use HSS drill bits in good condition.

Always use a magnetic bit holder when using short screwdriver bits. When screw-driving, apply a small quantity of liquid soap or similar to the screw threads to ease insertion.

7. USING THE LED WORK LIGHT

The LED work light allows you to keep a clear view under less illuminated circumstances. To turn on the light simply press the on/off switch. When you release the on/off switch, the light will be off.



WARNING: The light is a focussed beam and should never be pointed directly into the eyes of people or animal.

TROUBLESHOOTING

1. WHY DOES THE DRILL NOT TURN ON WHEN YOU PRESS THE SWITCH?

The forward and reverse switch, which is on top of the trigger, is positioned in the lock function.

Unlock the forward and reverse switch putting it into the required rotation position. Push the trigger and the drill will start to rotate.

2. THE DRILL STOPS BEFORE THE SCREW IS COMPLETELY TIGHTENED. WHY?

Verify the torque position of the torque adjustment ring, you can find the torque adjustment ring between the chuck and the drill body. Position 1 is the lowest torque (screw driving force) and position 15 is the highest torque (screw driving force). The position on the drilling mark is for drill operation. Regulate the torque adjustment ring to a higher position to reach the best result. Recharge battery if the drill suddenly stalls or rotates intermittently.

3. REASONS FOR DIFFERENT CHARGING TIMES.

Your charge time can be affected by many reasons, which are not defects in your product. If the battery pack is only partly discharged it may be re-charged in less than 30 min. If the battery pack and ambient temperature are very cold then recharging may take 1 hour. If the battery pack is very hot it will not re-charge because the internal temperature safety cutout will prevent it.

If the battery pack is very hot you must remove your battery pack from the charger and allow your battery pack to cool first to ambient temperature and then recharging can be started. If you charge a second battery pack immediately after the first then the charger can be overheated. Always allow at least 15 minutes rest between battery pack charging.

4. REASONS FOR DIFFERENT BATTERY PACK WORKING TIMES.

Charging time issues, as above, and having not used a battery pack for a prolonged time will reduce the working life of the battery pack.

This can be corrected after several charge and discharge operations by charging & working with your drill. Heavy working conditions such as large screws into hard wood will use up the battery pack energy faster than lighter working conditions. Do not re-charge your battery pack below 0°C and above 50°C as this will affect performance.

MAINTENANCE

Remove the battery from the tool and the plug from the socket before carrying out any adjustment, servicing or maintenance.

Your power tool requires no additional lubrication or maintenance. There are no user serviceable parts in your power tool. Never use water or chemical cleaners to clean your power tool. Wipe clean with a dry cloth. Always store your power tool in a dry place. Keep the motor ventilation slots clean. Keep all working controls free of dust. Occasionally you may see sparks through the ventilation slots. This is normal.

If the supply cord of the charger is damaged, it must be replaced by the manufacturer, its service agent or similarly qualified persons in order to avoid a hazard.

ENVIRONMENTAL PROTECTION



Waste electrical products should not be disposed of with household waste. Please recycle where facilities exist. Check with your Local Authority or retailer for recycling advice. For further information visit www.recyclamore.co.uk

DISPOSAL OF AN EXHAUSTED BATTERY PACK

To preserve natural resources, please recycle or dispose of the battery pack properly. This battery pack contains Li-Ion batteries. Consult your local waste authority for information regarding available recycling and/ or disposal options.

Discharge your battery pack by operating your drill, then remove the battery pack from the drill housing and cover the battery pack connections with heavy duty adhesive tape to prevent short circuit and energy discharge.

Do not attempt to open or remove any of the components.

UK PLUG REPLACEMENT

The fuse in the main plug of your charger should always be replaced with one of identical rating.

Check the voltage given on your charger matches the supply voltage.

The charger is supplied with a fitted plug, however if you should need to fit a new plug follows the instruction below.

IMPORTANT

The wire in the mains lead are coloured in accordance with the following code:

Blue ---Neutral

Brown ---Live

The wire that is coloured **blue** must be connected to the terminal that is marked with the letter **N**. The wire that is coloured **brown** must be connected to the terminal that is marked with the letter **L**.

A 13 AMP (BS1363 or BS1363/A) plug must be used and a 3 AMP fuse must be fitted.

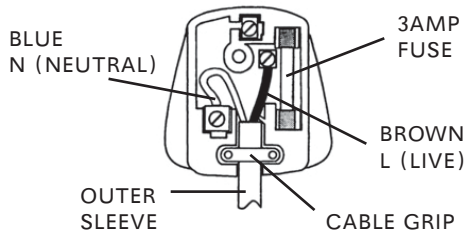

TITAN®

Declaration of Conformity

We, Importer

Titan Power Tools (UK) Ltd
Trade house, Mead Avenue, BA22 8RT

Declare that the product:

Designation: 10.8V Drill Driver

Model: TTP451DDH

Complies with the following Directives:

2004/108/EC Electromagnetic Compatibility Directive

2006/42/EC Machinery Directive

2006/95/EC Low Voltage Directive

2011/65/EU Restrictions of the Use of Certain Hazardous Substances in Electrical and Electronic Equipment

2002/96/EC and 2003/108/EC Waste Electrical and Electronic Equipment (WEEE)

Standards and technical specifications referred to:

Drill Driver :

EN 55014-1:2006 + A1:2009 + A2:2011

EN 55014-2:1997 + A1:2001 + A2:2008

Charger :

EN 55014-1:2006 + A1:2009 + A2:2011

EN 55014-2:1997 + A1:2001 + A2:2008

EN 61000-3-2:2006 + A1:2009 + A2:2009

EN 61000-3-3:2008

Machinery Directive, Low Voltage Directive 2006/42/EC, 2006/95/EC

Drill Driver :

EN 60745-1:2009 + A11:2010

EN 60745-2-1:2010

EN 60745-2-2:2010

Charger :

EN 60335-1:2002 + A1:2004 + A11:2004 + A12:2006 + A2:2006 + A13:2008 + A14:2010 + A15:2011

EN 60335-2-29:2004 + A2:2010

EN 62233:2008

Authorised Signatory and technical file holder

Date : 27/02/2013

Signature: P. C. Harries

Name / title: Peter Harries / Quality Manager

Titan Power Tools (UK)Ltd. Trade House , Mead Avenue ,BA22 8RT



10.8V DRILL DRIVER TTP451DDH