

Erbauer®



ERB567DRH

2Year
Guarantee

15kg BREAKER

ERB567DRH

Original Instructions
(Version 1.0)

Erbauer®

Congratulations on your purchase of a quality power tool from Erbauer (UK) Ltd. This product should give you reliable service but for your peace of mind this **Erbauer** power tool does carry a 2 year guarantee, the terms of which are detailed below.

If this product develops a fault within the guarantee period contact your retailer.

Please retain this handbook in case you need to refer to safety, care or guarantee information in the future.

GUARANTEE

This **Erbauer** product carries a 2 year guarantee. If your product develops a fault within this period, you should in the first instance contact the retailer where the item was purchased.

This guarantee specifically excludes losses caused due to:

- Fair wear and tear
- Misuse or abuse
- Lack of routine maintenance
- Failure of consumable items (such as batteries)
- Accidental damage
- Cosmetic damage
- Failure to follow manufacturer's guidelines
- Loss of use of the goods

This guarantee does not affect your statutory rights. This guarantee is only valid in the UK.

For further technical advice, spare parts or repair service (outside of guarantee) please contact the customer helpline number on 0345 607 6380.

15kg BREAKER

ERB567DRH

GENERAL POWER TOOL SAFETY WARNINGS

 **Warning: Read all safety warnings and all instructions.**
Failure to follow the warnings and instructions may result in electric shock, fire and/or serious injury.

Save all warnings and instructions for future reference.

The term “power tool” in the warnings refers to your electric (corded) power tool or battery-operated (cordless) power tool.

1. Work area safety

- a. **Keep work area clean and well lit.** Cluttered or dark areas invite accidents.
- b. **Do not operate power tools in explosive atmospheres, such as in the presence of flammable liquids, gases or dust.** Power tools create sparks which may ignite the dust or fumes.
- c. **Keep children and bystanders away while operating a power tool.** Distractions can cause you to lose control.

2. Electrical safety

- a. **Power tool plugs must match the outlet. Never modify the plug in any way. Do not use any adapter plugs with earthed (grounded) power tools.** Unmodified plugs and matching outlets will reduce risk of electric shock.
- b. **Avoid body contact with earthed or grounded surfaces, such as pipes, radiators, ranges and refrigerators.** There is an increased risk of electric shock if your body is earthed or grounded.
- c. **Do not expose power tools to rain or wet conditions.** Water entering a power tool will increase the risk of electric shock.
- d. **Do not abuse the cord. Never use the cord for carrying, pulling or unplugging the power tool. Keep cord away from heat, oil, sharp edges or moving parts.** Damaged or entangled cords increase the risk of electric shock.
- e. **When operating a power tool outdoors, use an extension cord suitable for outdoor use.** Use of a cord suitable for outdoor

use reduces the risk of electric shock.

f. If operating a power tool in a damp location is unavoidable, use a residual current device (RCD) protected supply. Use of an RCD reduces the risk of electric shock.

3. Personal safety

a. Stay alert, watch what you are doing and use common sense when operating a power tool. Do not use a power tool while you are tired or under the influence of drugs, alcohol or medication. A moment of inattention while operating power tools may result in serious personal injury.

b. Use personal protective equipment. Always wear eye protection. Protective equipment such as dust mask, non-skid safety shoes, hard hat, or hearing protection used for appropriate conditions will reduce personal injuries.

c. Prevent unintentional starting. Ensure the switch is in the off-position before connecting to power source and/or battery pack, picking up or carrying the tool. Carrying power tools with your finger on the switch or energising power tools that have the switch on invites accidents.

d. Remove any adjusting key or wrench before turning the power tool on.

A wrench or a key left attached to a rotating part of the power tool may result in personal injury.

e. Do not overreach. Keep proper footing and balance at all times. This enables better control of the power tool in unexpected situations.

f. Dress properly. Do not wear loose clothing or jewellery. Keep your hair, clothing and gloves away from moving parts. Loose clothes, jewellery or long hair can be caught in moving parts.

g. If devices are provided for the connection of dust extraction and collection facilities, ensure these are connected and properly used. Use of dust collection can reduce dust-related hazards.

4. Power tool use and care

a. Do not force the power tool. Use the correct power tool for your application. The correct power tool will do the job better and safer at the rate for which it was designed.

b. Do not use the power tool if the switch does not turn it on and off. Any power tool that cannot be controlled with the switch is dangerous and must be repaired.

c. Disconnect the plug from the power source and/or the battery pack from the power tool before making any adjustments, changing accessories, or storing power tools. Such preventive safety measures reduce the risk of starting the power tool accidentally.

d. Store idle power tools out of the reach of children and do not allow persons unfamiliar with the power tool or these instructions to operate the power tool. Power tools are dangerous in the hands of untrained users.

e. Maintain power tools. Check for misalignment or binding of moving parts, breakage of parts and any other condition that may affect the power tool's operation. If damaged, have the power tool repaired before use. Many accidents are caused by poorly maintained power tools.

f. Keep cutting tools sharp and clean. Properly maintained cutting tools with sharp cutting edges are less likely to bind and are easier to control.

g. Use the power tool, accessories and tool bits etc. in accordance with these instructions, taking into account the working conditions and the work to be performed. Use of the power tool for operations different from those intended could result in a hazardous situation.

5. Service

a. Have your power tool serviced by a qualified repair person using only identical replacement parts. This will ensure that the safety of the power tool is maintained.

b. If the replacement of the supply cord is necessary, this has to be done by the manufacturer or his agent in order to avoid a safety hazard.

ADDITIONAL SAFETY INSTRUCTIONS FOR YOUR TOOL

This is a powerful concrete breaker. Caution needs to be observed when operating.

- 1. Wear ear protectors.** Exposure to noise can cause hearing loss.
- 2. Use auxiliary handle, if supplied with the tool.** Loss of control can cause personal injury.
- 3. Hold power tool by insulated gripping surfaces, when performing an operation where the cutting accessory may contact hidden wiring or its own cord.** Cutting accessory contacting a “live” wire may make exposed metal parts of the power tool “live” and could give the operator an electric shock.
- 4. Always wear a dust mask.** A lot of dust will be created by the actions.
- 5. Safety boots are recommended at all times especially when using the chisel actions.**
- 6. Always wear proper safety gloves.**
- 7. Dress in suitable overalls.**
- 8. Do not use damaged or worn chisel bits.**
- 9. Do not run the machine with any part of the casing missing or damaged.**
- 10. Use a line detector to localize lines in walls with concealed electric, water or gas lines.** Avoid touching live components or conductors.
- 11. Always pay attention that chisel bits may be flung out of the machine accidentally and cause serious injury.**
- 12. Before starting to work, always check that the chisel or drill bit is properly locked in the chuck.**
- 13. Vibrations can injure the hand-arm system.** Keep exposure to vibrations as short as possible.
- 14. When carrying out work, always hold the tool with both hands and ensure that you have a stable standing position.**

ADDITIONAL SAFETY WARNING FOR CONSTRUCTION DUST

The updated Control of Substances Hazardous to Health Regulations 1st October 2012 now also targets to reduce the risks associated with silica, wood and gypsum dusts.

Construction workers are one of the at-risk groups within this because of the dust that they breathe: silica dust is not just a nuisance; it is a real risk to your lungs!

15kg BREAKER

ERB567DRH

Silica is a natural mineral present in large amounts in things like sand, sandstone and granite. It is also commonly found in many construction materials such as concrete and mortar. The silica is broken into very fine dust (also known as Respirable Crystalline Silica or RCS) during many common tasks such as cutting, drilling and grinding. Breathing in very fine particles of crystalline silica can lead to the development of:
Lung cancer
Silicosis
Chronic Obstructive Pulmonary Disorder (Chronic obstructive pulmonary disease (COPD))

And breathing in fine particles of wood dust can lead to the development of Asthma

The risk of lung disease is linked to people who regularly breathe construction dust over a period of time, not on the odd occasion.
To protect the lung, the COSHH Regulations sets a limit on the amount of these dusts that you can breathe (called a Workplace Exposure Limit or WEL) when averaged over a normal working day. These limits are not a large amount of dust: when compared to a penny it is tiny – like a small pinch of salt:
This limit is the legal maximum; the most you can breathe after the right controls have been used.

How to reduce the amount of dust?

1. Reduce the amount of cutting by using the best sizes of building products.
2. Use a less powerful tool e.g. a block cutter instead of angle grinder.
3. Using a different method of work altogether – e.g. using a nail gun to direct fasten cable trays instead of drilling holes first.

Please always work with approved safety equipment, such as those dust masks that specially designed to filter out microscopic particles and use the dust extraction facility at all time.

For more information please see the HSE website:

<http://www.hse.gov.uk/construction> or <http://www.hse.gov.uk/pubns/cis69.pdf>

 **Warning: Some dust particles created by power sanding, sawing, grinding, drill and other construction jobs contain chemicals known to cause cancer, birth defects or other reproductive harm.** Some examples of these chemicals are:

- Lead from lead-based paints.
- Crystalline silica from bricks and cement and other masonry products.
- Arsenic and chromium from chemically treated timber.

Your risk from these exposures varies, depending upon how often you do this type of work.

To

reduce your exposure to these chemicals:

- Work in a well-ventilated area.
- Work with approved safety equipment, such as those dust masks that are specially designed to filter microscopic particles.

VIBRATION

The European Physical Agents (Vibration) Directive has been brought in to help reduce hand arm vibration syndrome injuries to power tool users. The directive requires power tool manufacturers and suppliers to provide indicative vibration test results to enable users to make informed decisions as to the period of time a power tool can be used safely on a daily basis and the choice of tool.

Further Advice can be found at www.hse.gov.uk

Vibration total values (triax vector sum) determined according to EN 60745:		
Chiseling	Main handle	Vibration emission value $a_{h,Chaq} = 11.69\text{m/s}^2$
		Uncertainty $K = 1.5\text{m/s}^2$
	Auxiliary handle	Vibration emission value $a_{h,Chaq} = 10.82\text{m/s}^2$
		Uncertainty $K = 1.5 \text{ m/s}^2$

The declared vibration emission value should be used as a minimum level and should be used with the current guidance on vibration.

Calculating the actual period of the actual period off use can be difficult and the HSE website has further information.

The declared vibration emission been measured in accordance with a standardised test stated above and may be used to compare one tool with another tool.

The declared vibration emission value may also be used in a preliminary assessment of exposure.

 **Warning:** The vibration emission value during actual use of the power tool can differ from the declared value depending on the ways in which the tool is used dependant on the following examples and other variations on how the tool is used:

How the tool is used and the materials being cut or drilled.

The tool being in good condition and well maintained

The use the correct accessory for the tool and ensuring it is sharp and in good condition.

The tightness of the grip on the handles.

And the tool is being used as intended by its design and these instructions.

While working with this power tool, hand/arm vibrations occur. Adopt the correct working practices in order to reduce the exposure to vibration.

This tool may cause hand-arm vibration syndrome if its use is not adequately managed.

 **Warning:** identify safety measures to protect the operator that are based on an estimation of exposure in the actual conditions of use (taking account of all parts of the operating cycle such as the times when the tool is switched off and when it is running idle in addition to the trigger time).Note The use of other tools will reduce the users' total working period on this tool.

Helping to minimise your vibration exposure risk.

ALWAYS use sharp chisels, drills and blades

15kg BREAKER

ERB567DRH

Maintain this tool in accordance with these instructions and keep well lubricated (where appropriate)

Avoid using tools in temperatures of 10°C or less

Plan your work schedule to spread any high vibration tool use across a number of days.

Health Surveillance

All employees should be part of an employer's health surveillance scheme to help identify any vibration related diseases at an early stage, prevent disease progression and help employees stay in work.

Double insulation

The tool is double insulated. This means that all the external metal parts are electrically insulated from the mains power supply. This is done by placing insulation barriers between the electrical and mechanical components making it unnecessary for the tool to be earthed.

Important note

Be sure the supply is the same as the voltage given on the rating plate. The tool is fitted with a two-core cable and plug.

Remove the mains plug from socket before carrying out, any adjustment or servicing.

SYMBOLS



To reduce the risk of injury, user must read instruction manual



Warning



Double insulation



Wear ear protection



Wear eye protection



Wear dust mask



Wear safety gloves



Waste electrical products should not be disposed of with household waste.
Please recycle where facilities exist. Check with your Local Authority
or retailer for recycling advice.

yyWxx Manufacturing date code; Year of manufacturing (20yy) and week of manufacturing (Wxx);

15kg BREAKER

ERB567DRH

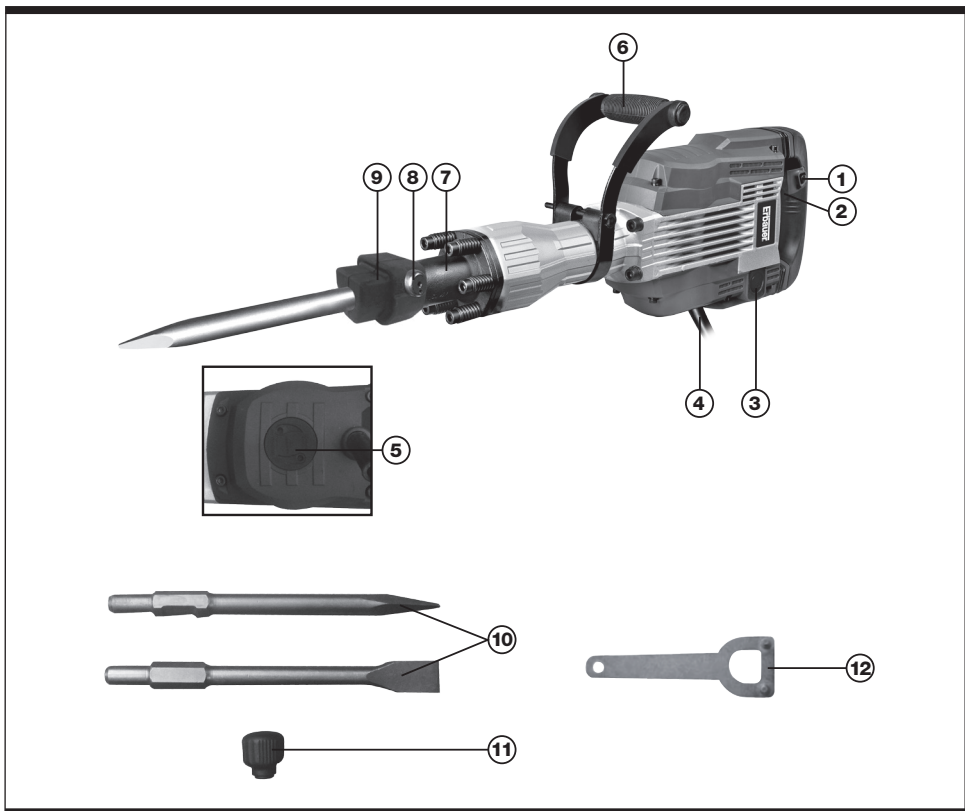

-
1. LOCK-ON BUTTON

 2. ON/OFF SWITCH

 3. CARBON BRUSH COVER

 4. POWER CORD

 5. GREASE BOX COVER

 6. AUXILIARY HANDLE

 7. CLAMP SEAT

 8. STOP LEVER

 9. DUSTPROOF COVER

 10. POINT CHISEL AND FLAT CHISEL

 11. KNOB FOR AUXILIARY HANDLE

 12. PIN SPANNER
-

TECHNICAL DATA

Type designation:	ERB567DRH
Voltage:	230-240V~ 50Hz
Power input:	1750W
Impact rate:	1380/min
Impact energy:	45J
Protection class:	□/II
Machine weight:	16.7Kg

NOISE INFORMATION

A weighted sound pressure:	L_{pA} : 82dB(A)	K_{pA} =3.0dB(A)
A measured weighted sound power:	L_{WA} : 102dB(A)	K_{WA} =4.12dB(A)
Guaranteed sound power level:	105 dB(A)	
Wear ear protection when sound pressure is over	80dB(A)	

ACCESSORIES

Auxiliary handle	1pc
Flat chisel	1pc
Point chisel	1pc
Pin spanner	1pc
Dust proof cover	1pc

15kg BREAKER

ERB567DRH

OPERATING INSTRUCTIONS



Note: Before using the tool, read the instruction book carefully.

INTENDED USE

The concrete breaker can be cut crushing asphalt, grooving and squaring, ram tamping sand and gravel, dig ground in various foundation, etc. The machine uses a single phase alternating current 230V, 50Hz motor, its compact and robust format makes it versatile and efficient for uses described in specific safety instructions. It complies to current regulations and the optimum quality of materials used will ensure a long working life in complete safety.

For low temperatures, new power tool or long-time storage, the machine reaches the full impact rate only after a certain time.

This start-up time can be shortened by striking the chisel in the machine against the floor one time.

Point chisel (For gravel)

Total length: 400mm

Standard size: 30mm (Hexagon)



Flat chisel (For crushing asphalt, grooving and squaring)

Total length: 400mm

Standard size: 30mm (Hexagon)

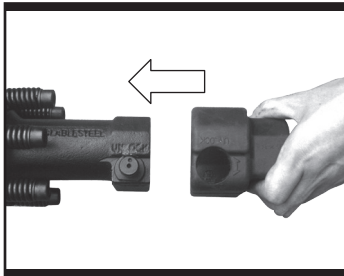

Fig. 1

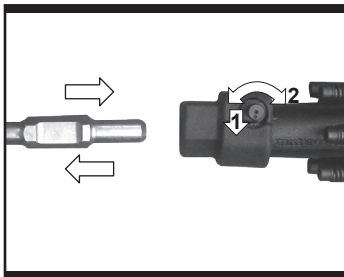

Fig. 2

1. DUSTPROOF COVER (See Fig. 1)

Before chiseling vertically fit the Dustproof cover over the drilling bit.



Caution: Always wear eye protection with this tool.

2. FITTING THE CHISEL (See Fig. 2)

1) Insert the chisel into the chuck.

2) Drag the stop lever and rotate it to “Lock” position.

3. REMOVE THE CHISEL (See Fig. 2)

1) Drag the stop lever and rotate it to “Unlock” position.

2) Remove the chisel.

4. FITTING THE AUXILIARY HANDLE (See Fig. 3)

For your personal safety we recommend using the auxiliary handle at all times.

Attached the handle as shown in Fig 3. To adjust the handle, loosen the knob on the auxiliary handle by hand.

Rotate the handle around the handle collar and/ or rotate the handlebar to the desired position.

Tighten the knob fully.

5. OPERATING THE ON/OFF SWITCH (See Fig. 4)

Holding the Breaker with both hands and depress the on/off switch then lock on button in for operation (see D), To switch off just release the on/ off switch.

6. GEARBOX MAINTENANCE(See Fig. 5)

This machine is of full air-tight construction to protect against dust and to prevent lubricant leakage. Therefore, the machine can be used without lubrication for long periods. Replace the grease as described below.

Fill about 30g grease ever 3 months (or working time reaches 120 hours) after purchasing. The grease specification is general purpose lithium based.

Open the grease box using the pin spanner provided as shown in Fig 5.

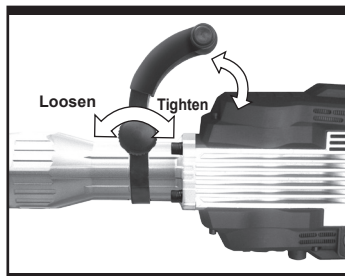

Fig. 3

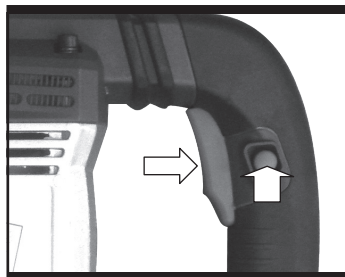

Fig. 4

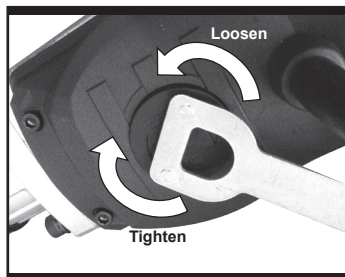

Fig. 5

WORK HINTS FOR YOUR BREAKER

If your power tool becomes too hot, set the speed to maximum and run a no load for 2-3 minutes to cool the motor.

Always use sharp good quality chisels. The performance of the tool is dependent on the quality of the bits used.

- Reduce the pressure on the chisel bit when it is about to break through.
- Always operate tool using both the handle and the front handle.
- Make sure that you wear safety glasses and protective gloves.
- Do not apply excessive pressure to the tool. Expressive force does not speed up the work.

MAINTENANCE

Remove the plug from the socket before carrying out any adjustment, servicing or maintenance.

There are no user serviceable parts in your power tool. Never use water or chemical cleaners to clean your power tool. Wipe clean with a dry cloth. Always store your power tool in a dry place. Keep the motor ventilation slots clean. Keep all working controls free of dust. Occasionally you may see sparks through the ventilation slots. This is normal and will not damage your power tool.

If the supply cord is damaged, it must be replaced by the manufacturer, its service agent or similarly qualified persons in order to avoid a hazard.

TROUBLESHOOTING

1. If your breaker do not start, check the plug and fuse on the mains supply first.
2. If your concrete breaker use in low efficiency, please check whether the chisel is blunt.

ENVIRONMENTAL PROTECTION



Waste electrical products should not be disposed of with household waste. Please  recycle where facilities exist. Check with your Local Authority or retailer for recycling advice. For further information visit www.recycle-more.co.uk.

PLUG REPLACEMENT (UK & IRELAND ONLY)

If you need to replace the fitted plug then follow the instructions below.

IMPORTANT

The wires in the mains lead are coloured in accordance with the following code:

BLUE = NEUTRAL

Brown = Live

As the colours of the wires in the mains lead of this appliance may not correspond with the coloured markings identifying the terminals in your plug, proceed as follows. The wire which is coloured blue

must be connected to the terminal which is marked with N. The wire which is coloured brown must be connected to the terminal which is marked with L.



Warning:

Never connect live or neutral wires to the earth terminal of the plug. **Only fit an approved**

13AMP

BS1363/A plug and the correct rated fuse.

Note: If a moulded plug is fitted and has to be removed take great care in disposing of the plug and severed cable, it must be destroyed to prevent engaging into a socket.

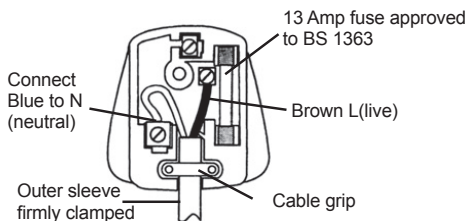

15kg BREAKER

ERB567DRH

Erbauer®

DECLARATION OF CONFORMITY

We, Importer
Erbauer (UK) Ltd BA22 8RT

Declare that the product
Description: **15kg Breaker**
Model: **ERB567DRH**

Complies with the following Directives,
EC Machinery Directive **2006/42/EC**
EC Low Voltage Directive **2006/95/EC**

EC Electromagnetic Compatibility Directive **2004/108/EC**

Restrictions of the Use of Certain Hazardous Substances in Electrical and Electronic Equipment **2011/65/EU**

Waste Electrical and Electronic Equipment (WEEE) **2012/19/EU**

2000/14/EC amended by **2005/88/EC** Noise Emission in the Environment by Equipment for Use
Outdoors Directive

- Measured Sound Power Level **102dB(A)**

- Declared Guaranteed Sound Power Level **105dB(A)**

The conformity assessment followed was according to Annex III of the directive for
equipment listed in schedule 1 / article 12 the chosen conformity assessment route

Internal control of production (schedule 10 / **Annex V**)

Notified body Societe Nationale de Certification et d'Homologation

Notified Body Identification Number: 0499

Standards conform to:

EN 55014-1

EN 55014-2

EN 61000-3-2

EN 61000-3-3

EN 60745-1

EN 60745-2-6

EN ISO 3744

Authorised Signatory and technical file holder

Date: 28/05/15

Signature: P. C. Harries

Name / title: Peter Harries / Quality Manager

Erbauer (UK) Ltd. Trade House, Mead Avenue, BA22 8RT



Erbauer®