



# ALTO CONTRACT IDEALFORM ACRYLIC BATHS

## Installation Instructions

**Please pass on to user**

# ALTO CONTRACT IDEALFORM ACRYLIC BATH

## TECHNICAL INFORMATION

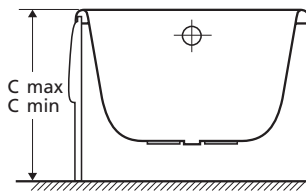
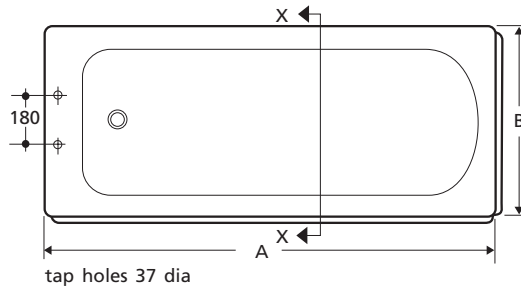

Section X - X

**Fig. 1**

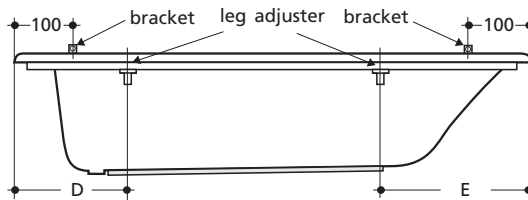





















**Fig. 2 centres of leg adjusters**

All dimensions shown in millimetres.  
Dimensions shown may vary within permitted tolerances.

	A	B	C Max	C Min	D	E	Water capacity to overflow ltrs
Alto CT WS	1695	695	540	500	370	495	140
Alto CT WS	1695	695	540	500	370	495	149
Alto CT	1695	695	540	500	370	495	175
Alto CT	1495	695	540	500	370	495	149

# ALTO CONTRACT IDEALFORM ACRYLIC BATH

Ref.	Description		Qty.
A	Bath Tub		1
B	Bath Legs		2
C	Centre Support Leg		1
D	Short Bath Foot		1
E	Bath Feet		4
F	Plastic Leg Adjuster		4
G	Bath Feet Locking Nuts		10
H	No. 8 x 12 Pan Head Self Tapping Screw	 	4
J	No. 8 x 16 Countersunk Woodscrew	 	2
K	No. 8 x 20 Pan Head Self Tapping Screw	 	10
L	No. 8 x 30 Countersunk Woodscrew	 	4
M	Wall Bracket		2
<b>Front Panel</b>			
V	Panel		1
W	Cushioning Strip		3
<b>End Panel</b>			
X	Panel		1
W	Cushioning Strip		2

**Fig. 3**

# ALTO CONTRACT IDEALFORM ACRYLIC BATH

## BATH CONDITION

Before commencing installation, carefully remove packaging/protective film and check for damage. If damaged, report immediately to supplier.

The bath should be fully protected during the installation process.

Fig. 1 illustrates baths fitted with rigid panels

***Appropriate safety equipment/workwear should be used***

## INSTALLATION

1. Lay bath face down and remove legs and bags containing feet etc.

***The 4 black - No. 8 x 40 long countersunk crosshead self tapping screws retaining the legs are NOT REQUIRED and should be discarded.***

2. Locate leg adjusters on bath frame and mark positions for the fixing screws.  
Note: If fitting wooden panels, locate outside face of leg adjuster flush with outside face of frame. Pilot drill Ø2mm holes in the bath frame and fix leg adjusters to frame.
3. Locate bath legs in leg adjusters and mark positions for the fixing screws on the base board. Pilot drill Ø2mm holes in the base board, to a depth of 6mm maximum. Position legs in leg adjusters and on base board and secure. Locate No. 8 x 12 long pan head self tapping screw into leg adjuster and tighten.

### DO NOT OVER TIGHTEN

4. Locate centre support bracket, mark screw hole positions, pilot drill Ø2mm holes in base board, to a depth of 6mm maximum, and secure bracket.
5. Fix the feet and adjust to give approximate floor to top of rim height required. Trial fit the panel(s) to verify height is correct.  
**Note:** Untrimmed panel fitment requires the maximum height adjustment (Cmax Fig1). Remember to allow for flooring thicknesses.
6. Fit supply and waste fittings. If the bath is to be installed with a monoblock mixer a special hole (or holes) is required to accommodate the mixer and will have to be cut by the installer in an appropriate position on the rim of a no tap hole bath to suit the bathroom layout. Full details or a template for cutting the hole (or holes) is supplied with monoblock fittings. A template for cutting two tap holes in a no tap hole bath is supplied with the bath. Cut tap holes, and fit supply fittings, waste, overflow and trap. When using a monoblock fitting, the area directly behind the pop-up waste mechanism should be avoided.

# ALTO CONTRACT IDEALFORM ACRYLIC BATH

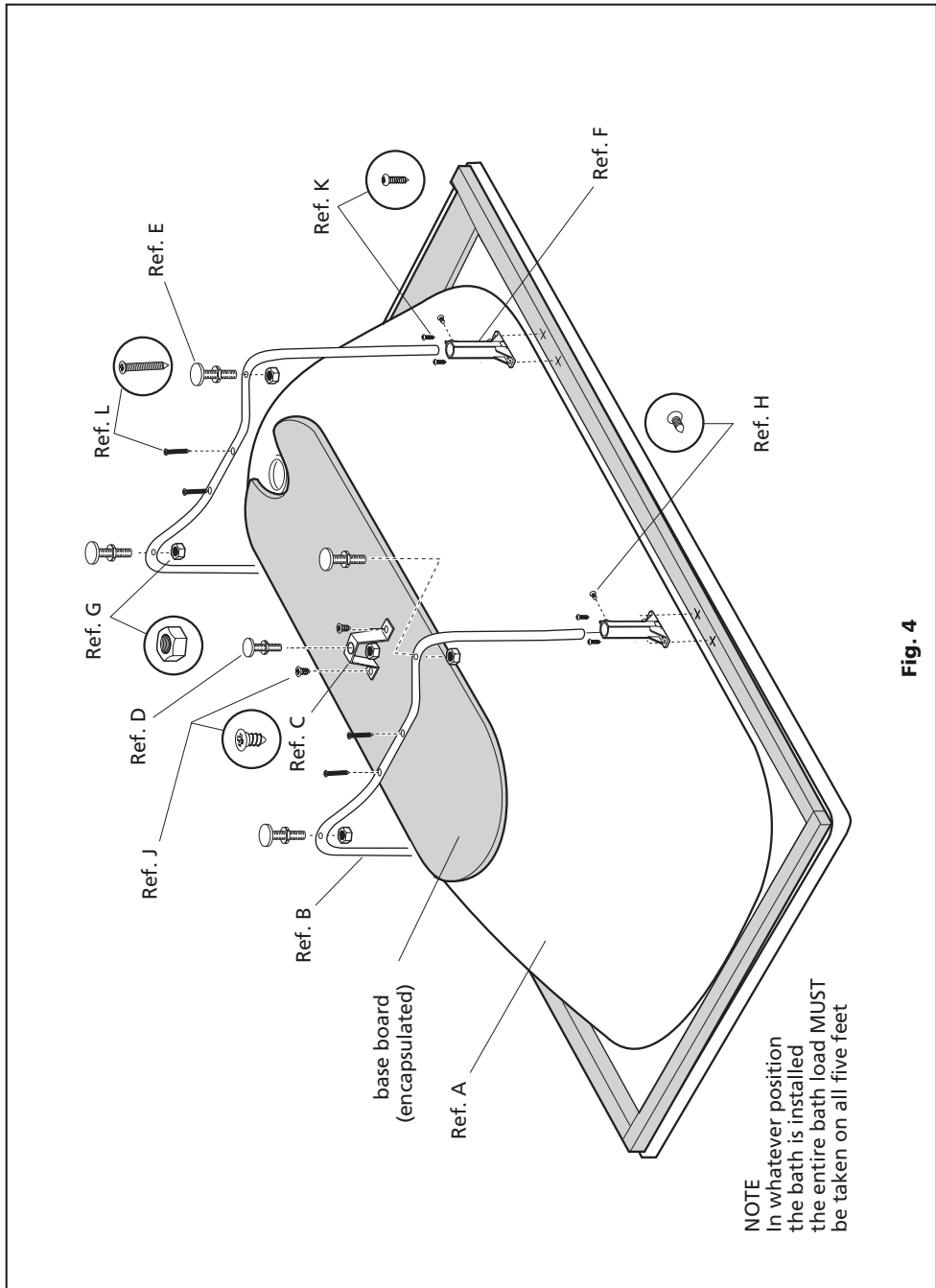

Fig. 4

NOTE  
In whatever position  
the bath is installed  
the entire bath load MUST  
be taken on all five feet

## ALTO CONTRACT IDEALFORM ACRYLIC BATH

7. Fix handgrips where supplied.

### WARNING

DO NOT fix hand grips in any oil based bedding compound or putty. These materials contain solvents which will damage the hand grips irreparably.

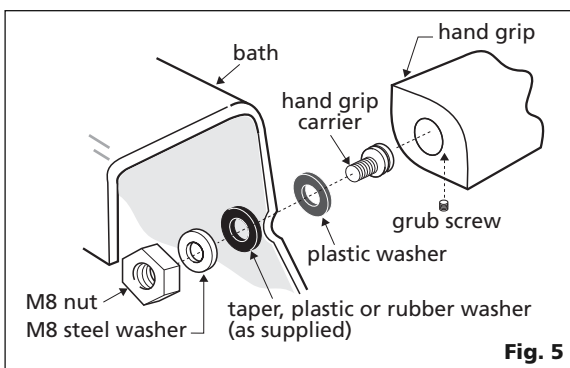

**Fig. 5**

8. Fix the two wall fixing brackets to bath frame as indicated in Fig. 6. Pilot drill  $\varnothing 2\text{mm}$  holes in frame before fixing brackets.
9. Fix bath to wall (Fig. 6)
10. Fix bath to floor and ensure that all nuts are tight.
11. Connect services, test for satisfactory operation of fittings and ensure there are no leaks.
12. Tile down to the height of the bath rim leaving a 3-4mm gap for waterproof sealant, see Fig. 6. An extruded sealing strip can be used for the bath to wall joint as an alternative to waterproof sealant. Protect bath during tiling.

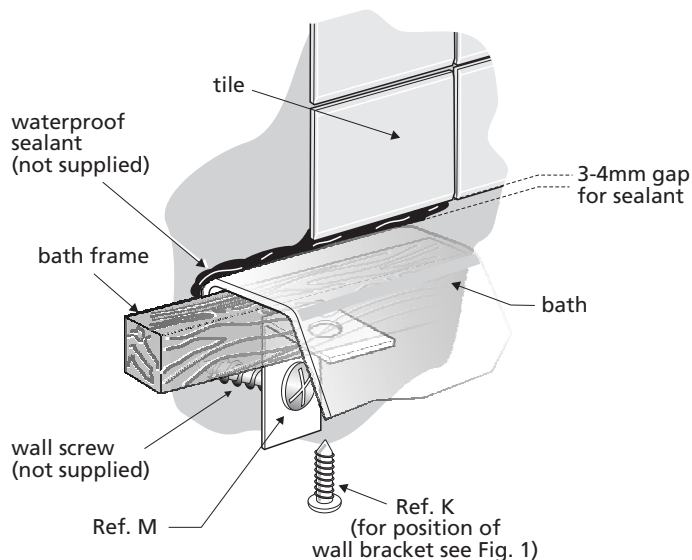

**Fig. 6**

# ALTO CONTRACT IDEALFORM ACRYLIC BATH

## PANELS

### 13. Fit panel(s)

Attach the lengths of PVC cushioning strip to the top edge(s) of the panel(s) (three on the front panel and two on the end).

Fit panel(s) (end panel first where appropriate) by pushing the top edge under the bath rim, Fig. 7.

### 14. Panels can be reduced in height by cutting a strip from the bottom edge, for heights see Fig. 1. Reducing the panel height requires great care and responsibility cannot be accepted for any errors made.

Timber floor battens are not supplied but are necessary to secure the panels. Screw battens to the floor.

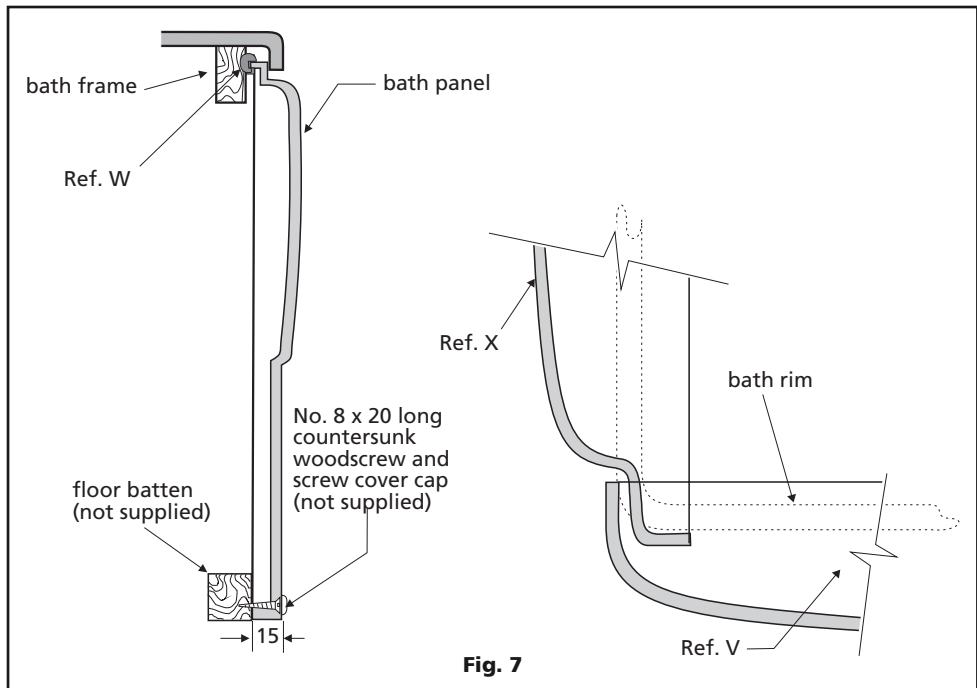

## WOODEN PANELS

### 15. Wooden panels can be supported on battens or blocks attached to the bath frame. Battens are also required for the base of panels and should be screwed to the floor.

Screw wooden panels to battens and blocks and cover screw heads with screw caps (not supplied). Installation details for fixing wooden panels to the bath are supplied with the panels.

# ALTO CONTRACT IDEALFORM ACRYLIC BATH

---



The Bathroom Works  
National Avenue  
Kingston upon Hull  
HU5 4HS England  
Telephone: (01482) 346461  
Telefax: (01482) 445886.

**CUSTOMER CARE HELPLINE**  
**0870 1296085**  
**CUSTOMER CARE FAX LINE 01482 499611**  
**email: [ukcustcare@IdealStandard.com](mailto:ukcustcare@IdealStandard.com)**

We pursue a policy of continuing improvement in design and performance of our products. The right is, therefore, reserved to vary specifications without notice.

Ideal Standard (UK) Ltd.



*Armitage  
Shanks*





**Close Coupled WC**  
Assembly and  
Installation Instructions

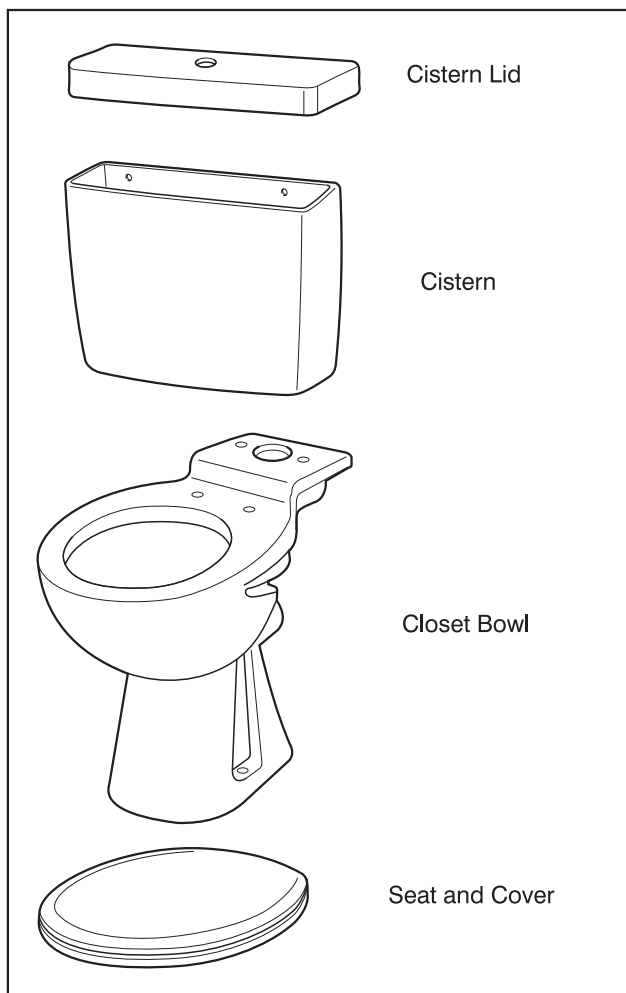



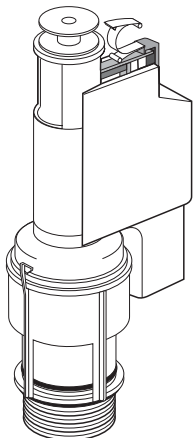
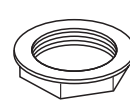
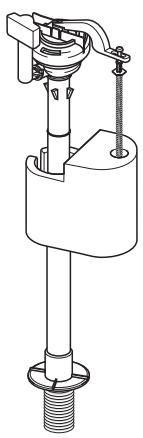





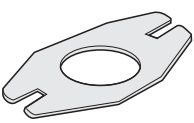





## Parts Supplied



### Fixings Supplied

<b>A</b>	<b>B</b>	<b>D</b>	<b>E</b>
 Flush Valve	 Flush Valve Backnut	 Inlet Valve	 Inlet Valve Backnut
x 1	x 1	x 1	x 1
	<b>C</b>		<b>F</b>
	 Flush Valve Washer		 Inlet Valve Washer
	x 1		x 1

<b>G</b>	<b>H</b>	<b>I</b>	<b>J</b>	<b>K</b>
 Coupling Plate	 Coupling Plate Bolt	 Coupling Plate Washer	 Coupling Plate Wing Nut	 Sealing Gasket (Donut Washer)
x 1	x 2	x 2	x 2	x 1

<b>L</b>	<b>M</b>	<b>O</b>	<b>P</b>	<b>R</b>	<b>T</b>
 Push-Button	 Push Button Washer	 Ratchet Bar	 Plunger 'A'	 Push Button Cover Cap	 Flow Restrictor
x 1	x 1	x 4	x 1	x 1	x 1
	<b>N</b>		<b>Q</b>	<b>S</b>	<b>U</b>
	 Push Button Backnut		 Plunger 'B'	 Push Button Cover Cap	 Screw Cover Cap
	x 1		x 1	x 1	x 5

### Tools Required (not supplied)

- Adjustable Spanner
- Screwdriver
- Sharp Knife
- Pencil or Marker Pen
- Power Drill and suitable bit(s)

### Parts Required (not supplied)

- Brass Screws and Fixing Plugs to secure the cistern to the wall
- Brass Screws and Fixing Plugs to secure the pan to the floor

### Before You Start

- Check the pack and make sure you have all the parts listed. If not, contact the vendor who will be able to help you.
- When you are ready to start, make sure that you have the right tools to hand, plenty of space and a clean area for assembly.

### Important Notes

- The flow restrictor (T) should be used if the inlet water pressure to the inlet valve exceeds 1.4 Bar.
- Take care to avoid cross-threading. Do not overtighten backnuts.
- **Caution:** Care should always be taken when drilling into walls and floors to avoid any sunken wires or pipes.
- **Please Note:** Although these instructions are comprehensive, it is always recommended that a technically competent installer should undertake installation.
- **Servicing valve:** The Water Regulations have a requirement to fit a servicing valve adjacent to the cistern. (Not supplied).

## Assembly

- Remove the backnut (E) from the inlet valve (D).

Insert the inlet valve through the hole in the base of the cistern, ensuring the washer (F) is in place to seal and centralise the valve in the hole. Secure the inlet valve in position with the backnut, making sure the inlet valve is not in contact with the cistern wall.
- Remove the backnut (B) from the flush valve (A). Insert the flush valve through the hole in the base of the cistern, ensuring that the washer (C) is in place.

Place the coupling plate (G) over the tail of the flush valve.

Secure the flush valve using backnut, making sure that the flush valve is not in contact with the inlet valve.
- Place the sealing gasket (donut washer) (K) into the recess on the backplate of the WC pan.

Place the two coupling plate bolts (H) into the slots on either side of the coupling plate (G).

Lower the cistern onto the backplate of the WC pan.

Secure the cistern in position by applying washers (I) and wing nuts (J) onto the bolts (H).

Do not overtighten.

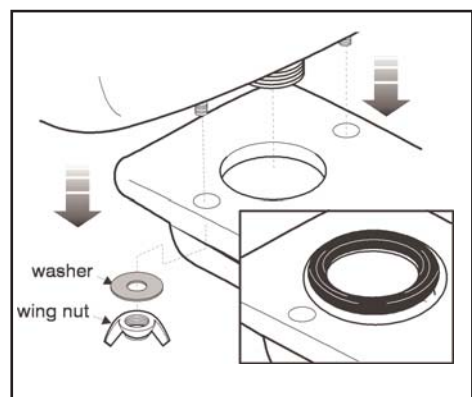
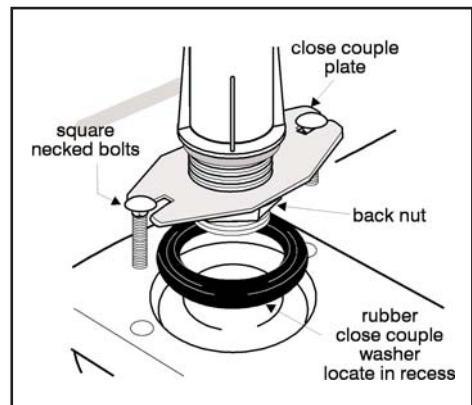
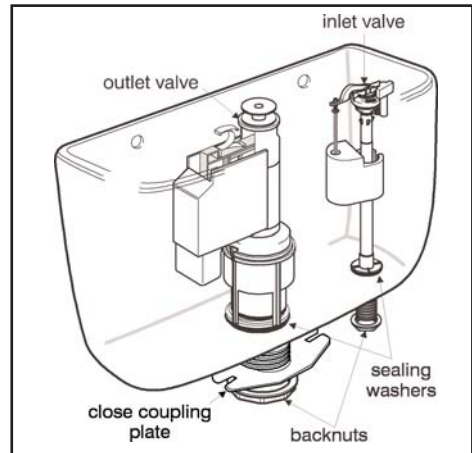

## Assembly

- 4 Place the WC in the required position. With cistern lid removed, mark the position of the screw holes in the rear of the cistern and in the base of the pan. Remove the WC away from its location and drill and plug the positions marked on the wall and floor. Replace the WC in position and secure to the wall and floor using suitable fixings (not supplied).

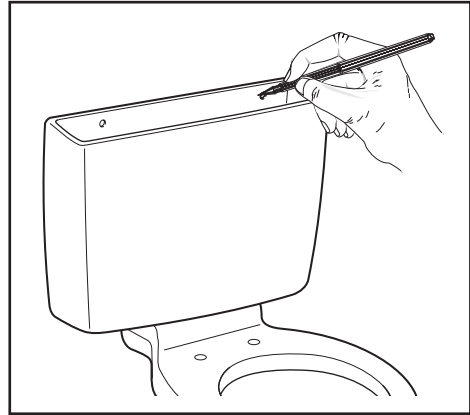

5. Connect the water supply and waste connections. Turn on the water supply and allow the cistern to fill. Adjust the float on the inlet valve so that the valve stops the flow of water when the water level is at the same height as the waterline marked in the cistern. Check for leaks.



## Fit Push Button

- Fit the push button (L) into the cistern lid and secure with the washer (M) and backnut (N), aligning the ratchet bar slots left and right

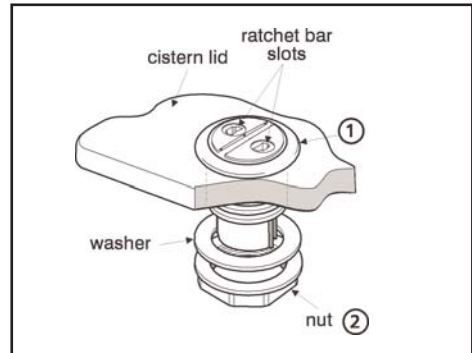

- Push ratchet bars (O) through the push button slots with the spigot ends facing downwards and outwards, so that the bars project approximately 10mm from the cover bush bosses. Push the small button plunger marked 'A' (part P), onto the right hand ratchet bar. Push the large button plunger marked 'B' (part Q) onto the left hand ratchet bar.

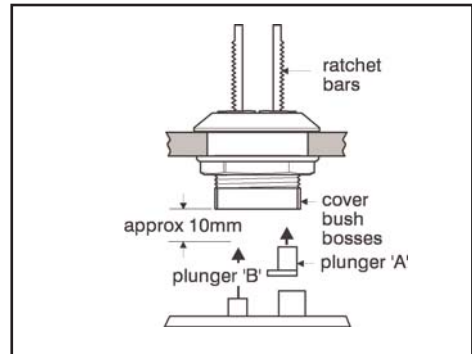

- Lower the cistern lid onto the cistern. whilst holding the left hand button firmly down, push the top end of the ratchet bar with a thin screwdriver down until it stops, then release.
- Repeat above step for the right hand button.
- If the top ends of the ratchet bars are level or below the push button face, push the cover caps, (R & S), onto the corresponding buttons, ensuring they snap into place.

11. If the ratchet bars protrude above the push button face, make a mark on the ratchet bars, level with the button faces.

12. Remove the cistern lid and pull the ratchet bars out of the button from underneath, then remove plungers 'A' and 'B'.

13. Cut the ratchet bars on the first notch below the mark.

14. Push ratchet bars (O) through the push button slots with the spigot ends facing downwards and outwards, until the top of the ratchet bars are level or just below the push button face.

Push the small button plunger marked 'A' (part P) onto the right hand ratchet bar. Push the large button plunger marked 'B' (part Q) onto the left hand ratchet bar. Push the cover caps (R and S) onto the corresponding buttons, ensuring they snap into place.

15. Lower the cistern lid onto the cistern.

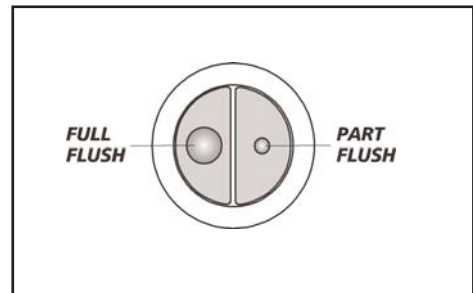
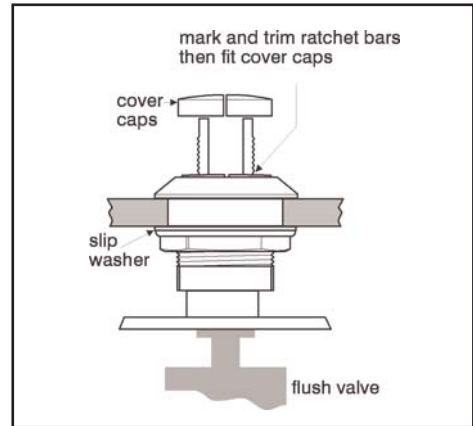

### Care and Use

- Clean using warm soapy water only.
- Do not use scourers, abrasives or chemical cleaners.



## Product Care

All our products are designed, manufactured and supplied to give many years of reliable service, provided they are properly maintained and cared for.

These are our recommendations to make sure that your bathroom stays looking good:

### Vitreous China – Ceramic toilets, cistern tanks

#### Do's

Use warm soapy water, cream or liquid cleaner.

Occasional use of mild bathroom lime scale removers is acceptable.

Use in accordance with manufacturers instructions, rinsing well with plenty of water.

Inlet valve filter to be cleaned regularly.

#### Don't

Do not put bleach products in the cistern – this can damage the internal fittings.

It is acceptable to use in the toilet bowl itself.

Never put strong cleaner or bleach in overnight.

Never mix different cleaners in the WC – they can react to give off poisonous gas.

### Plastic WC Seats

#### Do's

Clean immediately after use to stop a build up of dirt and scale.

Use warm soapy water, Cif cream cleaner or Domestos Multi Active surface cleaner.

Polish out minor scratches and abrasions with a mild polishing compound.

#### Don't

Never leave pools of soap, shampoo or cleaning detergent (please see above) – these can cause permanent stains.

Never let cigarettes/flames near - your seat can burn and melt.

Never use household chemicals – a range of products such as paint stripper, nail varnish remover, household bleach, perfume, aftershave or strong disinfectant.

We cannot recommend the use of any scouring products or cream cleaners other than Cif.

Never mix different cleaners on your seat – they can react to give off poisonous gas.

## **Product Guarantee**

**L I F E T I M E**

**All Ideal Standard ceramic products**

**5 Y E A R S**

**Toilet seat and cover**

**WC cistern fittings**

This covers products in domestic use by the consumer and not commercial or business use.

All Ideal Standard products must be installed, used and cared for in line with our fixing instructions, local water byelaws and current water regulations.

Access to our products for installation, service or repair and costs relating to this is the owners or installers' responsibility.

Parts are guaranteed for five years and will be replaced if found faulty.

This guarantee does not cover general wear and tear.

Applies to the UK and Republic of Ireland only.

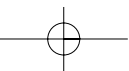
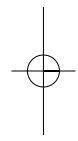
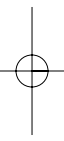

**CUSTOMER CARE HELPLINE**  
**0870 1258905**  
**FAX LINE 01482 499611**  
**email: [ukcustcare@IdealStandard.com](mailto:ukcustcare@IdealStandard.com)**

We pursue a policy of continuing improvement in design and performance of our products. The right is, therefore, reserved to vary specifications without notice.

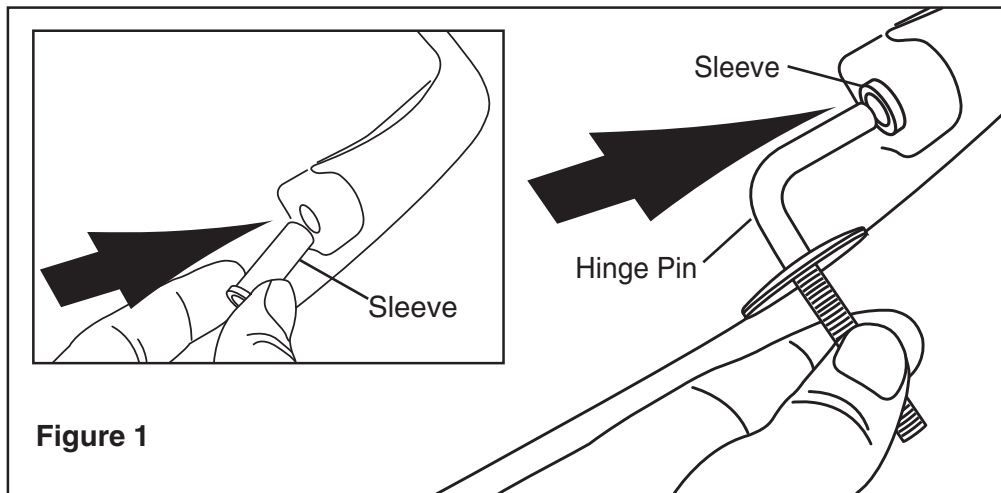

Figure 1

Ensure that the plastic sleeves, that lock the seat and cover together, are present, Figure 1, before inserting the hinge pins into the sleeves.

Check the orientation of the hinges, Wall Hung pans throw backwards, Figure 2a, Close Coupled and Back to Wall pans throw forwards, Figure 2b. This ensures that the seat lines up correctly.

Fit rubber centralising washers into the holes in the pan and lower the seat and cover, Figure 3, ensuring that the hinges are inserted in the holes in the centralising washers.

Firstly fit a plastic coated washer, then a steel spring washer and nut to the thread of each hinge, Figure 4, before tightening with the tool provided.

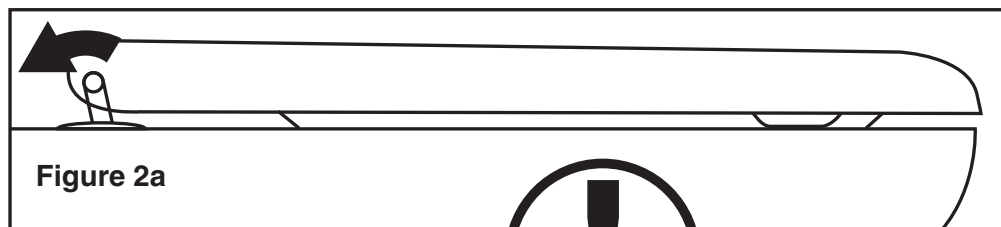

Figure 2a



Figure 2b

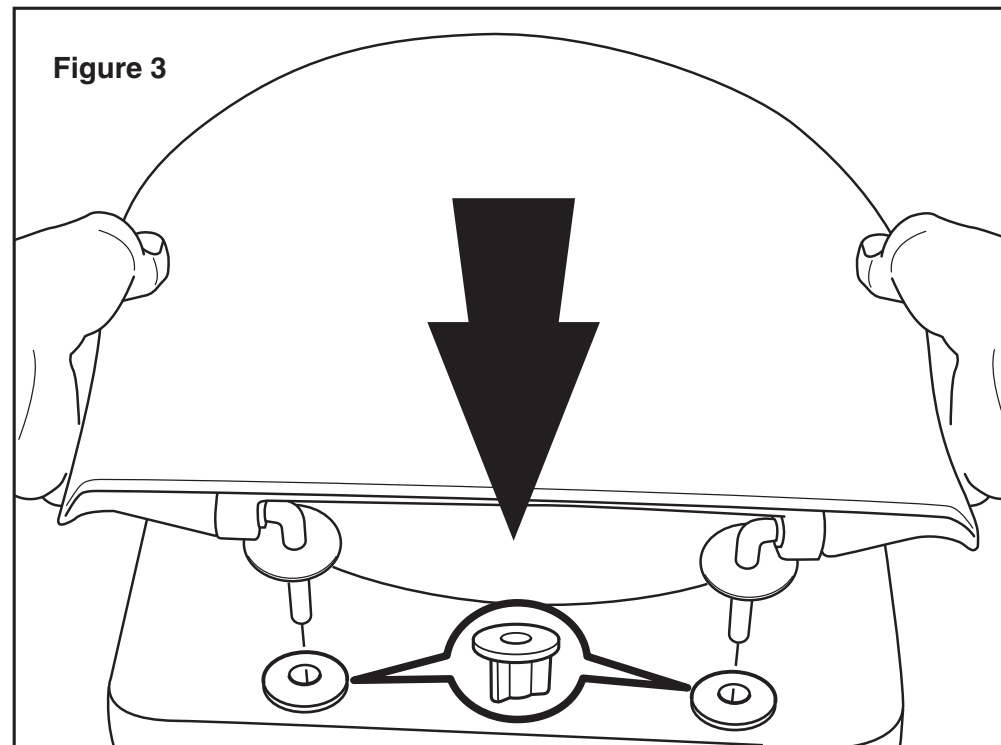

Figure 3

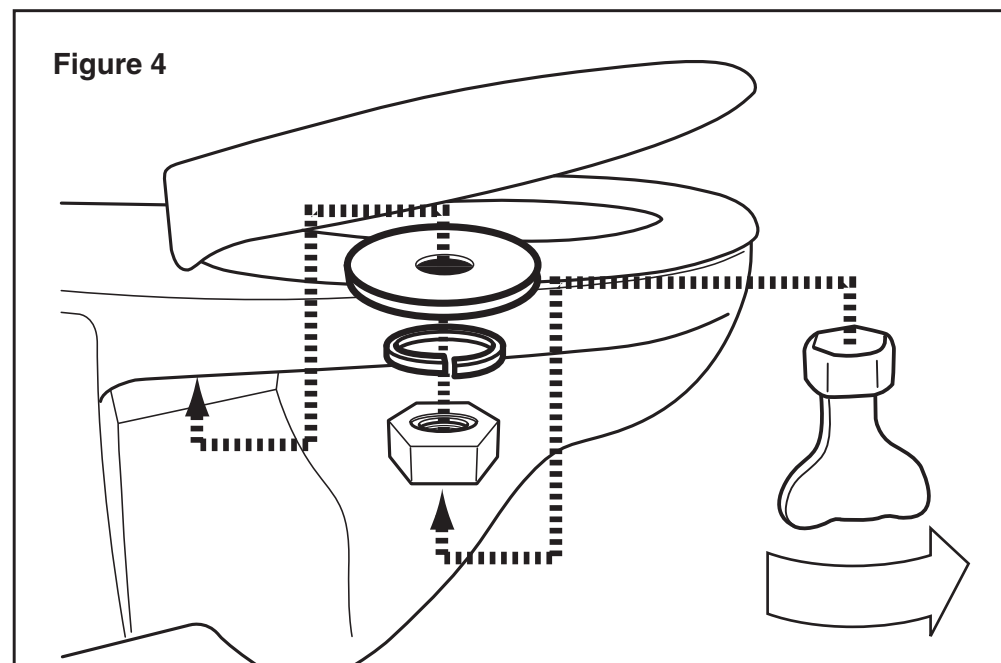

Figure 4

□ **CARE AND CLEANING INSTRUCTIONS**

- The seat and cover should be cleaned using warm soapy water.
- Do not use aggressive or abrasive cleaners as this may scratch the surface of the seat.
- The hinges should be cleaned using soap, or a mild detergent. After cleaning the hinges should be rinsed in clean water and dried.
- Never use bleach, concentrated cleaners or acids on the hinges as this will cause discolouring and pitting.
- Do not leave bleach in the toilet bowl with the cover closed because this may cause discolouration of the seat and hinges.
- Take care not to splash the hinges when using bleach in the toilet bowl.

The Bathroom Works  
National Avenue  
Kingston upon Hull  
HU5 4HS  
England  
Telephone: (01482) 346461  
Telefax: (01482) 445886.

**CUSTOMER CARE HELPLINE**  
**0870 1296085**  
**FAX LINE 01482 499611**  
ukcustcare@idealstandard.com

Ideal Standard (UK) Ltd. pursues a policy of continuing improvement in design and performance of its products. The right is, therefore, reserved to vary specifications without notice.

4453 05/08

## Toilet Seat Installation Alto and Halo Closets

Important Care and  
Installation Instructions,  
Please retain for future reference.