



tado°

Manual & Technical Documentation v1.1

tado° Smart Thermostat
tado° Extension Kit

ENGLISH

Content

Product Packages	1
Compatibility	2
Intelligence & Security	2
Functions	3
Smart Thermostat	4
• Usage	4
• Menu Structure	5
• Special States	6
• Pairing & Reset	7
• Interfaces	8
• Correct placement of the Smart Thermostat as a Sensor	8
Extension Box	9
• Usage	9
• Pairing & Reset	9
• Mechanical Design	10
• Interfaces	11
Bridge	12
Installation	13
Support	13
Technical Specifications	14
Regulatory Conformity	14

Product Packages

1 tado° Smart Thermostat

- Measures temperature, humidity, noise & luminosity
- Displays the measured temperature and allows the adjustment of operation and set point
- Controls heating when wired to the heating system
- Acts as a sensor and remote control when installed in combination with the Extension Box (depends on the existing heating setup)

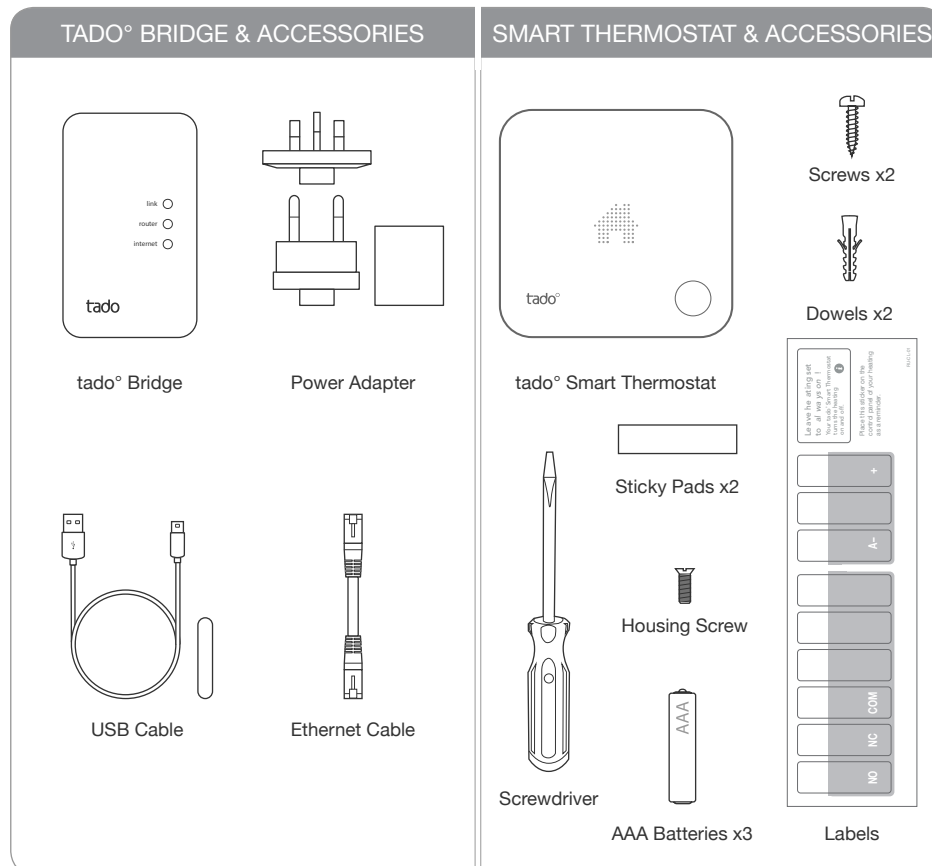

2 tado° Extension Kit

- Required for the replacement of hot water controlling programmers (UK only)
- Recommended for heating system setups without a room thermostat. The Extension Box acts as a receiver; the Smart Thermostat as a wireless sensor and remote control
- Controls heating based on sensor data from the tado° Smart Thermostat
- Typically installed next to the boiler or replacing an existing external controller
- Compatible with the UK standard backplate

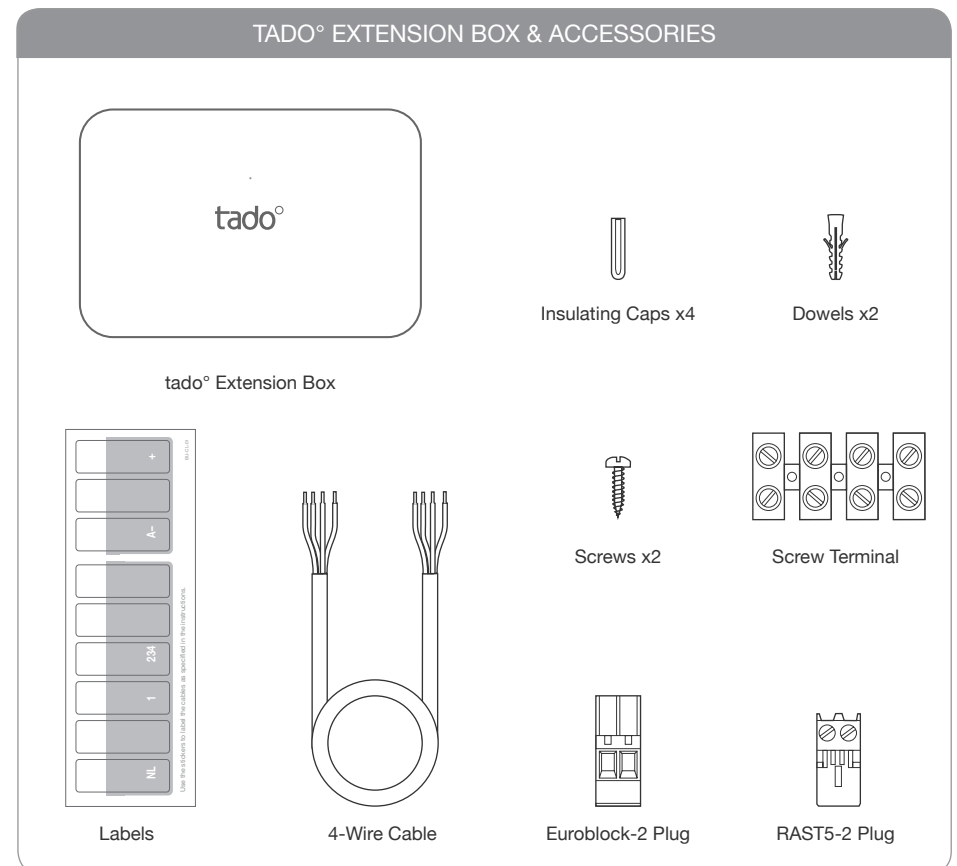

Compatibility

Compatibility

tado° is compatible with almost all central heating systems, including:

- combi, system and heat-only boilers
- conventional and condensing boilers
- common Y-, S- and W-plan setups
- hydronic underfloor systems
- electric underfloor systems with a maximum switching current of 6 A
- air source and ground source heat pumps (heating only)
- zoned systems (one Smart Thermostat per zone)
- switched live systems
- potential free (dry contact) systems
- low voltage systems with analog interfaces
- low voltage systems with digital bus interfaces

tado°'s compatibility with specific heating systems can be checked at www.tado.com

COMPATIBILITY CHECK



If tado° is bought online the compatibility is checked during the installation process.



In cases where tado° is bought from an installer, they will check the compatibility.

Intelligence & Security

Model Predictive Control

tado° does not require presence or absence time programming. Patents have been filed for the algorithms which automatically adjust the heating output to the user's needs. A building model is automatically created for each household which allows tado°'s proprietary model of predictive control to include weather forecasts in the control strategy and therefore optimize energy usage and comfort at home.

Location Based Heating

The tado° Smart Thermostat controls the temperature automatically depending on the residents location and distance from home and will only heat when it is really needed.

Encryption of Communication

Any communication between web browsers or smartphones and the tado° application servers is encrypted with TLS 1.2 (SSL) Encryption with a 2048-bit Extended Validation Certificate.

The communication between the tado° Bridge and the tado° Application Servers is encrypted with TLS 1.2 (SSL) using 256-bit elliptical curve encryption.

The radio communication between the tado° devices uses AES-CCM encryption. The key is exchanged by pairing the devices as part of the initial installation procedure.

Functions

Functions

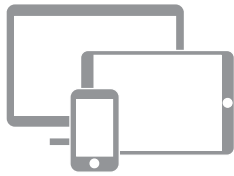

tado° has been developed for mobile phone and web use. The settings are most easily controlled using the tado° mobile app. It is available for iOS (> Version 7.1), Android (> Version 2.3) and Window Phone (> Version 8.1). The app is free.

Besides the control of settings and management of data, the tado° app also provides a detailed report of the heating history and a feature to compute a savings estimate.

The tado° web app is accessible on computers and tablets and contains the same features as the mobile app.

Meaning of Selected Symbols



When a flame is shown, tado° is requesting heat from the heating system. This does not necessarily mean that the boiler will start immediately or that a flame is present. Modern boilers apply additional control logic regarding when to switch on or off in response to a heat request.



Similar to a greenhouse, sunshine can significantly increase the inside temperature of a room. Possible solar influence is shown using the sun symbol in the report.

Heating Operations

There are three different heating operations.

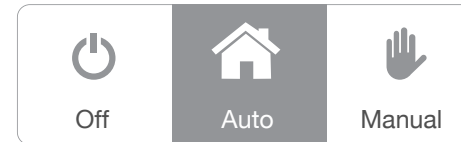

Off: When set to Off, tado° only heats when the room temperature drops below 5°C to avoid frost damage.

Auto: When set to Auto, tado° controls the heating based on the residents location and schedule. It can be adjusted to the preferred home and sleep temperatures. The optimal away temperature is set by tado° automatically depending on the residents' location.

Manual: When set to Manual, tado° keeps the room temperature at the selected set point temperature.

Hot Water Operations

The hot water functions of tado° are not supported by all heating systems. In the application, the hot water functions are displayed only if the heating system supports hot water control. For hot water there are four operations.



Off: When set to Off, no hot water is prepared.

Auto: When set to Auto, tado° prepares hot water according to anticipated need, eg. based on the residents' location and statistical data about expected need.

Schedule: When set to Schedule, tado° prepares hot water according to the settings in the dedicated hot water schedule. It can be set in the web application.

Manual: When set to Manual, tado° prepares hot water constantly.

Smart Thermostat

tado° Smart Thermostat



The tado° Smart Thermostat replaces existing thermostats or acts as a wireless thermostat together with the tado° Extension Box for heating systems that didn't have a wired thermostat before. It measures room temperature and allows the user to modify operation and set point temperature. If it is wired to the boiler it directly controls the heating. If it is not wired, it communicates with the boiler via the tado° Extension Box.

The tado° Smart Thermostat is powered by three AAA batteries which are included in the packaging. The paper strip must be removed from the battery case to activate the power supply. Batteries typically last for two years. tado° informs the user via email and/or push notification when it is time to replace the batteries.

! Please read the chapter "Installation" before installing.

Mechanical Design

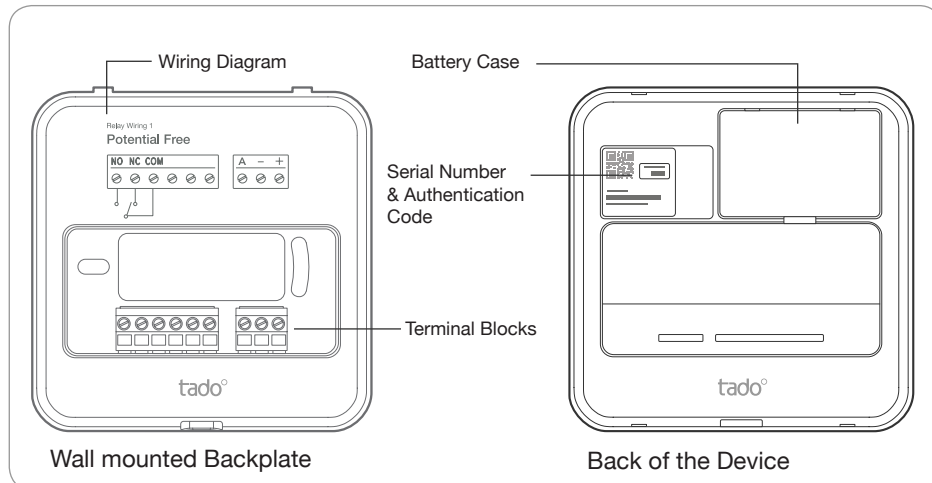

Smart Thermostat – Usage

Usage

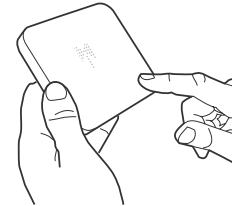







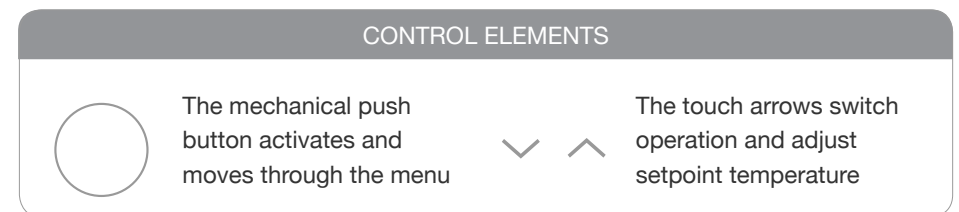
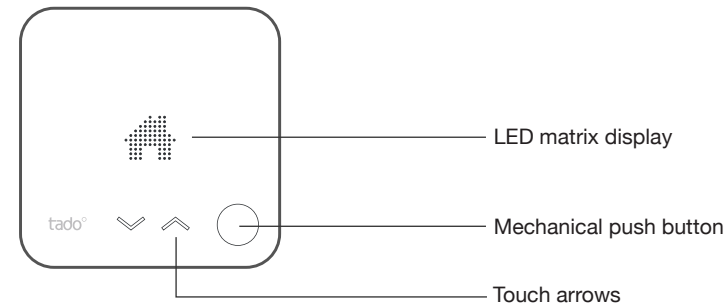













The tado° Smart Thermostat has a user interface which is activated by pressing the button in the bottom right corner. First, the current temperature is displayed. The mechanical button on the bottom right can be used to flip through the menu. The next press switches to the Operation/Mode screen.

After pressing the button once more, the setpoint temperature is displayed and can be adjusted using the touch arrow buttons, which light up when settings can be changed. Setting changes are stored after 3 seconds which is indicated by a flashing of the setting. Saving the setting can also be achieved by pushing the mechanical push button. The setting is stored and the UI switches to the next menu point.

On heating systems that support hot water preparation, the current hot water state (on/off or temperature on specific systems) and hot water operation are accessible by pressing the mechanical push button again. The activation notifications are shown immediately after pressing the mechanical push button for activating the UI.



Smart Thermostat – Menu Structure

HEATING			HOT WATER (not supported by all heating systems)			
1. State (1x button push)	2. Operation / Mode (2x button push)	3. Change Settings (3x button push)	4. State (4x button push)		5. Hot Water Operation (5x button push)	
 Current Temperature	Auto Operation  Home <hr/>  Sleep <hr/>  Away <hr/>  Preheat (Animation)	∇∧  Home Temperature <hr/> ∇∧  Sleep Temperature <hr/> Not setable  Away Temperature <hr/> ∇∧  Home Temperature <hr/> ∇∧  Manual Temperature	Shown for relay hot water systems <hr/>  Hot Water On <hr/>  Hot Water Off	Shown for digital bus hot water systems <hr/>  Hot Water Current Temperature	 Hot Water Auto Operation <hr/> ∇∧  Hot Water Schedule Operation <hr/> ∇∧  Hot Water Manual Operation (On) <hr/> ∇∧  Hot water Off	
	Manual Operation 	∇∧  Manual Temperature				
	Off 					
		Auto Operation  Presence & absence not visible				

Smart Thermostat – Special States

Activation Notifications

The activation notifications are shown immediately after pressing the mechanical button to activate the user interface.

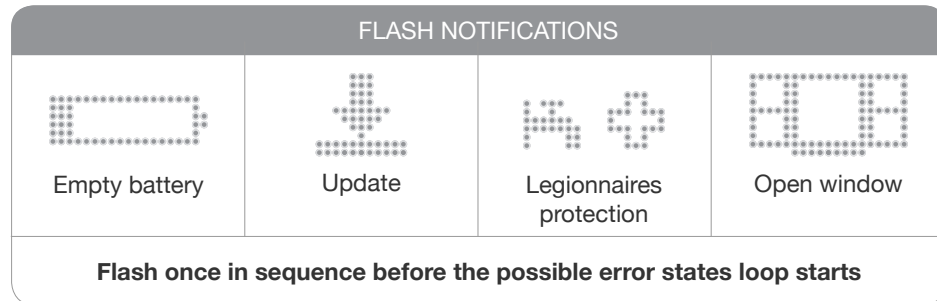

The error states display any connection error.

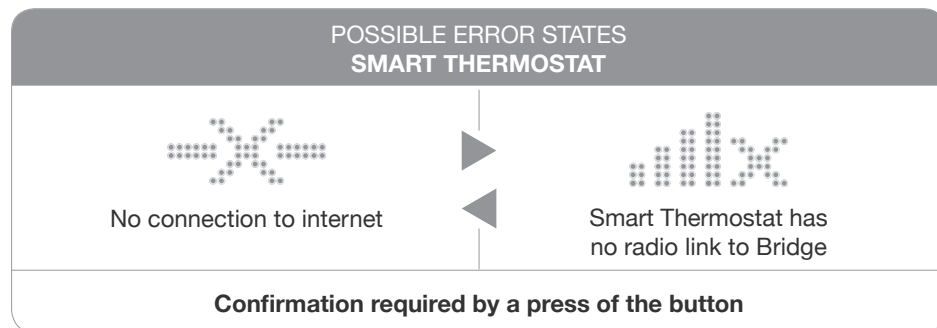

The states and behaviour are different if an Extension Kit is used.

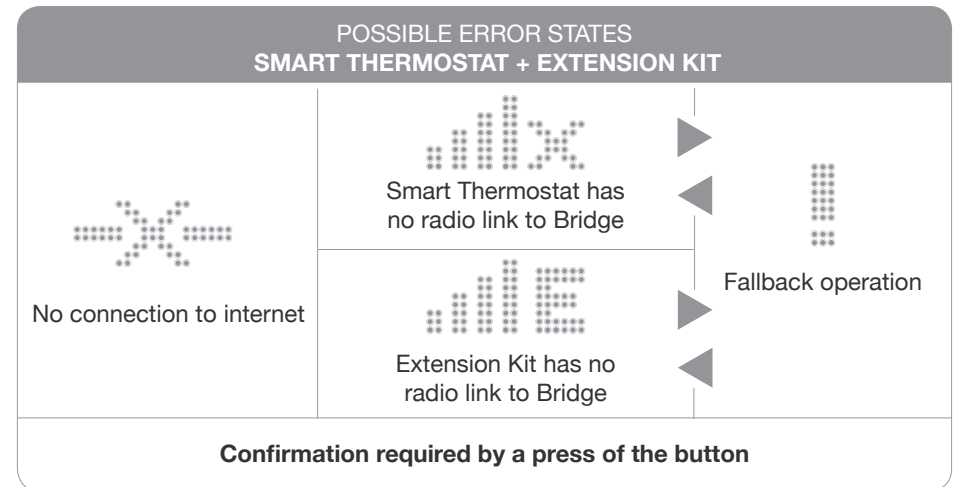

If the installation is not yet finished the wrench icon is displayed.

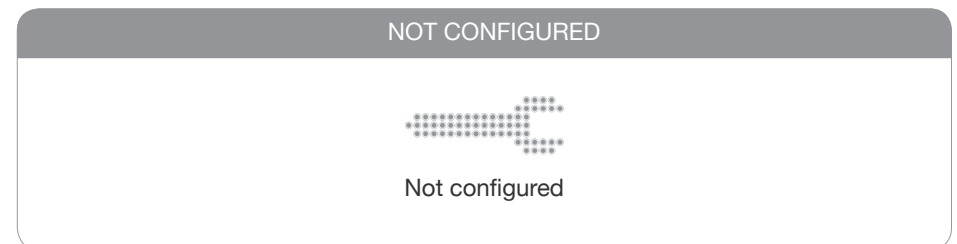

Smart Thermostat – Pairing & Reset

As part of the installation the Smart Thermostat and the Bridge need to be paired.

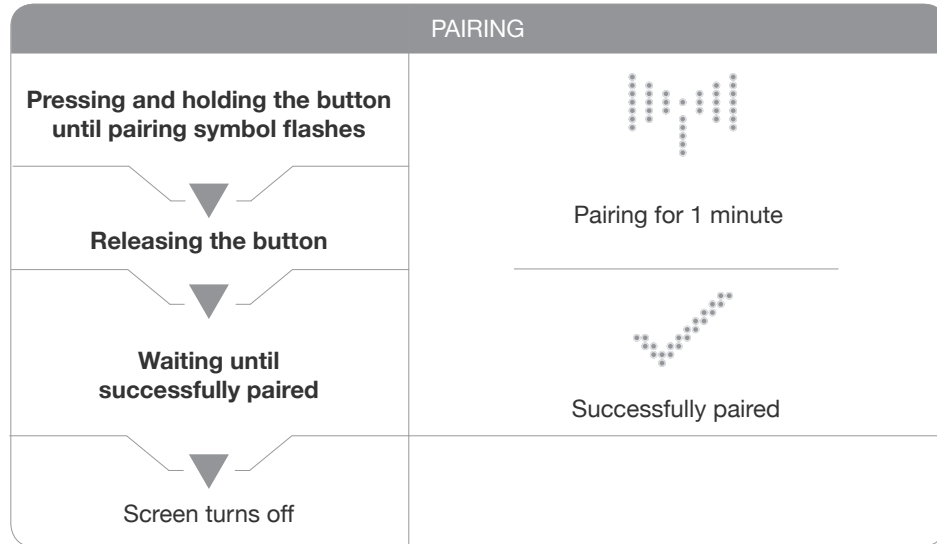

The Smart Thermostat can be reset for troubleshooting.

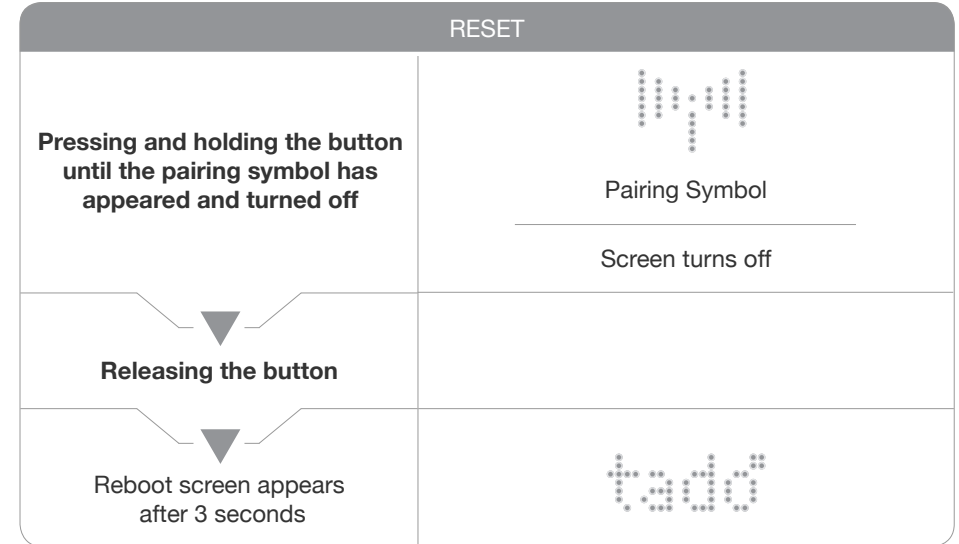

Smart Thermostat – Interfaces

Interfaces

The tado° Smart Thermostat supports both 230V and extra low voltage interfaces. The wiring diagram on the back of the device shows the wiring for the relay operation, three isolated parking slots for excess wiring (from the thermostat which is to be replaced) and three low voltage terminals for analog and bus connection.

When replacing a relay thermostat, COM and NO (and NC if present in the current thermostat) should be connected. Any additional wires, such as a neutral wire are placed into the parking slots without labeling next to the relay terminals. They do not have any function other than safely parking excess wires.

To replace an analog thermostat, the three extra low voltage terminals on the right hand side are used. The analog output is connected to “A”, ground (GND) to “-” and the positive input (Vcc) to “+”.

When replacing a two-wired digital thermostat, the two extra low voltage terminals labeled with “-” and “+” are used. Digital bus interfaces are typically protected against polarity reversal, thus the order of connection does not matter.

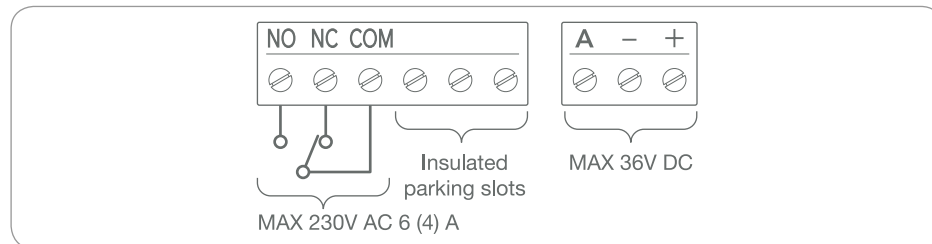

When replacing wireless thermostats, the additional purchase of the tado° Extension Kit is recommended. The tado° Extension Box replaces an existing external receiver or external controller; or is connected directly to the boiler. The tado° Smart Thermostat can then be placed in any suitable location without a wired connection being required.

Correct Placement of the Smart Thermostat as a Sensor

In cases where the tado° Smart Thermostat **does not replace an existing wired thermostat**, it can be placed in any appropriate location. When installing the Smart Thermostat the following points should be observed:

- The Smart Thermostat should be placed in a location which is representative for the temperature which should be set. This is usually the living room
- The Smart Thermostat should be placed on an inside wall at approx 1.5 m from the ground
- Areas where the Smart Thermostat is exposed to direct sunlight at any time of the day should be avoided
- The Smart Thermostat should be placed away from any draft (near a door or window) or heating sources such as radiators or electric devices

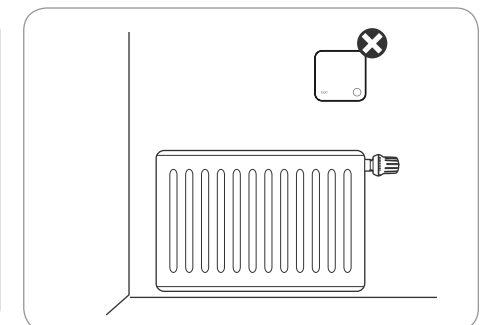
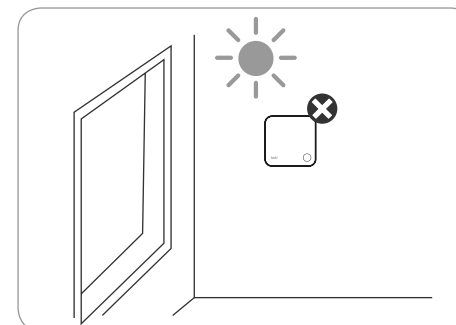
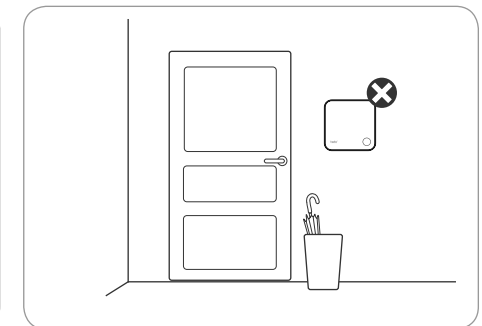
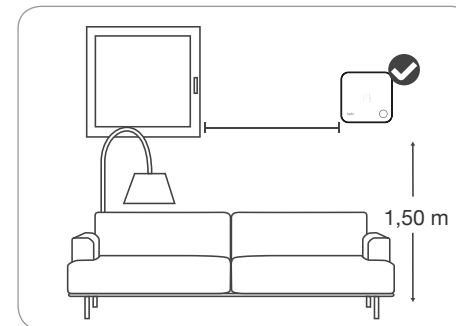

Extension Box

tado° Extension Box



The tado° Extension Box acts as a communication link between the tado° Smart Thermostat and the boiler. It replaces external controllers, external receivers or is directly connected to the boiler.

The Extension Box is powered by a 230V mains connection for relays or by a low voltage power supply when connected to analog or digital interfaces. For potential free relay wiring, an additional two wire power supply cable maybe required which is provided by tado° upon request.



Please read the chapter "Installation" before installing.

Extension Box – Usage

Usage

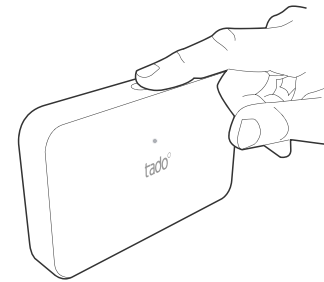

The Extension Box has one mechanical button and one white LED that shines through the front housing. The LED pulses slowly during normal operation.

LED Display

LED ACTION	MEANING
Off	No Power
Blinking	Connecting
Blinking (Fast)	Pairing
Pulsing (Slow)	Normal Operation

Pairing & Reset

During installation the Extension Box needs to be paired with the Bridge. The Extension Box can be set into pairing mode by pressing the mechanical button for around 4-5 seconds (until the LED starts blinking fast) and subsequently releasing it. The Extension Box automatically pairs with the Bridge. The LED will start pulsing slowly when it has contacted our servers (normal operation).

The Extension Box can be reset by pressing the mechanical button for more than 8 seconds until the LED turns off. The Extension Box then restarts when the button is released.

Extension Box – Mechanical Design

Mechanical Design

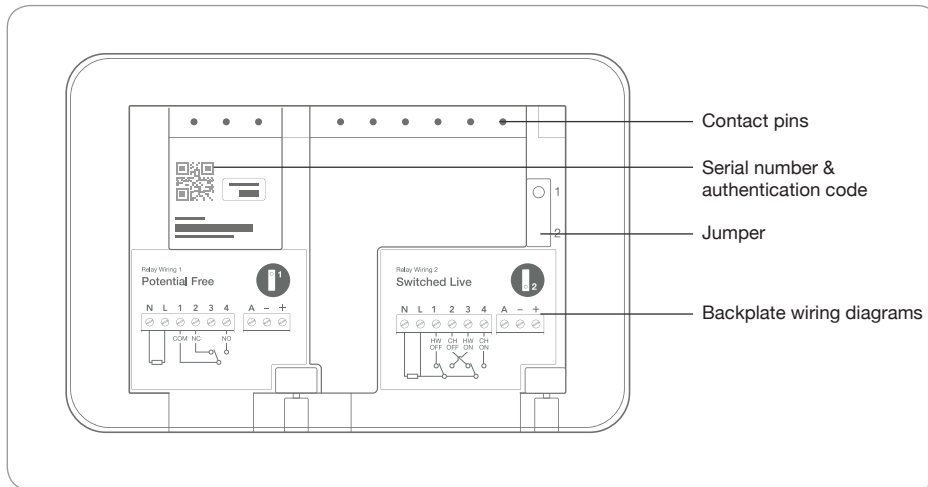

Back of the Device

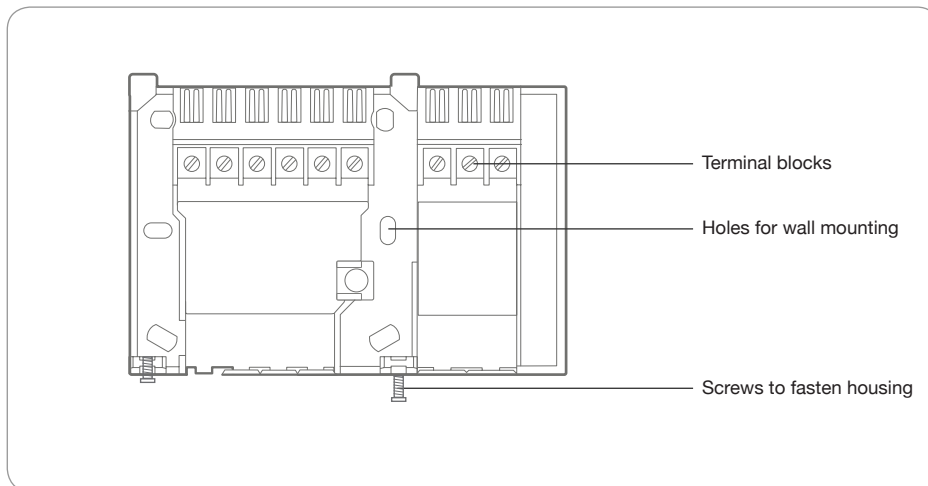

Wall Mounted Backplate

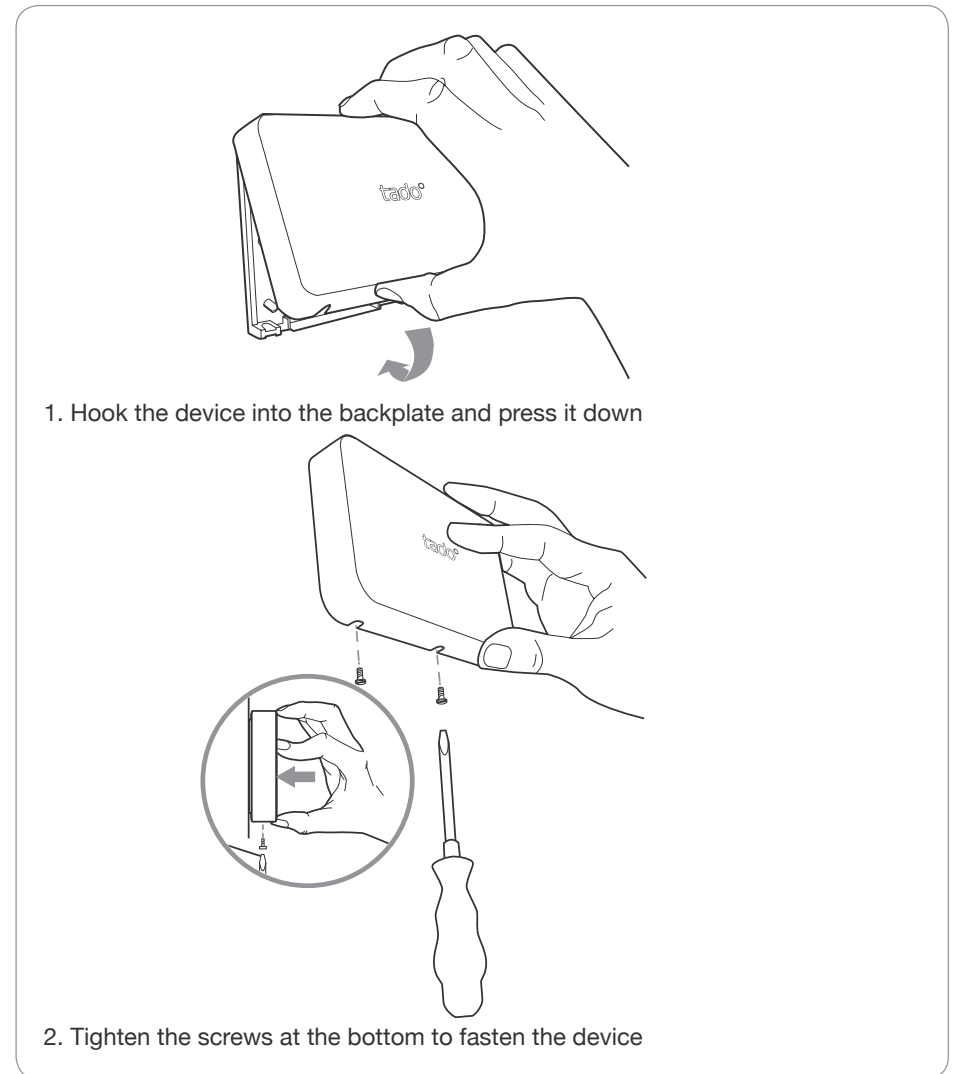

Mounting

Extension Box – Interfaces

Interfaces

The tado° Extension Box has connectors for relays (labeled 1-4) as well as analog and digital interfaces (labeled A, -, +). Two relay wiring configurations are possible and are distinguished by two different jumper positions.

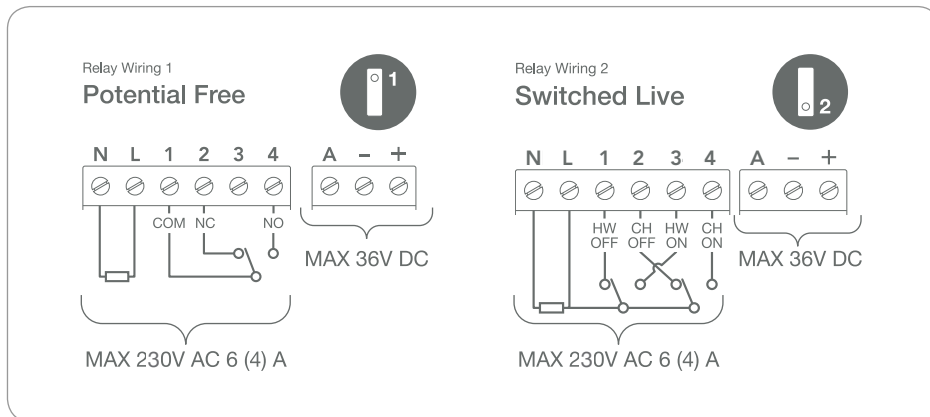

Relay Wiring Diagrams

Jumper Position 1: Potential Free Wiring Connection

The power supply is separated from the relays. This wiring option is to connect low voltage single relays. In case a UK standard backplate is present some rewiring might be required such that the wires correspond to tado°'s "Relay Wiring 1" as indicated on the back of the Extension Box.

Jumper Position 2: Switched Live

This wiring option corresponds to a 230V dual relay programmer. In case a UK standard backplate is present and wired as a 230V dual relay (central heating and hot water) the tado° Extension Box can simply be mounted on the existing backplate and does not require any rewiring.

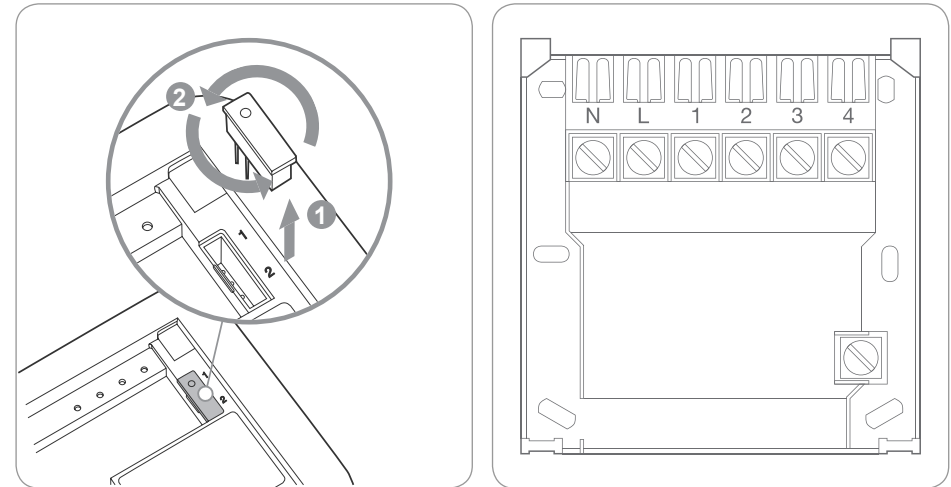

Switching the Jumper Position

UK Standard Backplate

Analog and Digital Connection

To connect an analog thermostat, the analog output is connected to "A", ground (GND) to "-", and the positive input (Vcc) to "+".

To connect a two-wired digital thermostat, the two extra low voltage terminals labeled with "-" and "+" are used. Digital bus interfaces are typically protected against polarity reversal, thus the order of connection does not matter.

Bridge

tado° Bridge



The tado° Bridge is the intermediary device between the Smart Thermostat, the Extension Box (if present) and the tado° Servers. It is connected to a router via an ethernet cable and communicates wirelessly with the Smart Thermostat and the Extension Box.

Connecting the Bridge

USB POWER ADAPTER

Connect the ethernet port to the router and the USB port to power via the power adapter.

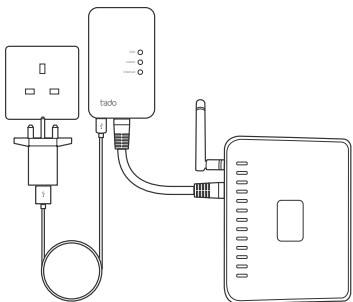

USB JACK ON ROUTER

Connect the ethernet port to the router and the USB port to power via the router.

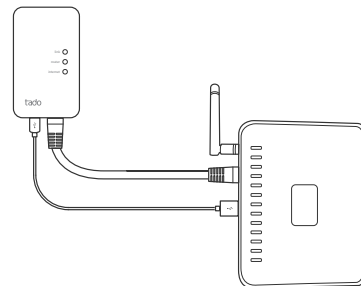

INFO: Upon plugging in the Bridge, all three LEDs should light up once. If this doesn't happen, the Bridge is either not sufficiently supplied with power or is defective.

Bridge LED Actions

LINK LED ACTION		MEANING
	Off	No power
	Blinking (Fast)	Pairing

ROUTER LED ACTION		MEANING
	Off	No ethernet link detected
	Blinking	Ethernet link detected. Awaiting DHCP IP address assignment
	On	IP address assigned successfully

INTERNET LED ACTION		MEANING
	Off	Off until IP address has been assigned
	Blinking	Establishing connection to tado° Server
	On	Connection to tado° Server has been established

Installation

tado° Installation

tado° provides installation instructions specific to every heating setup. These instructions are provided via an interactive installation assistant. The documentation at hand is **not a replacement** for these instructions and is a general documentation of tado° devices and features, not of the installation process itself.

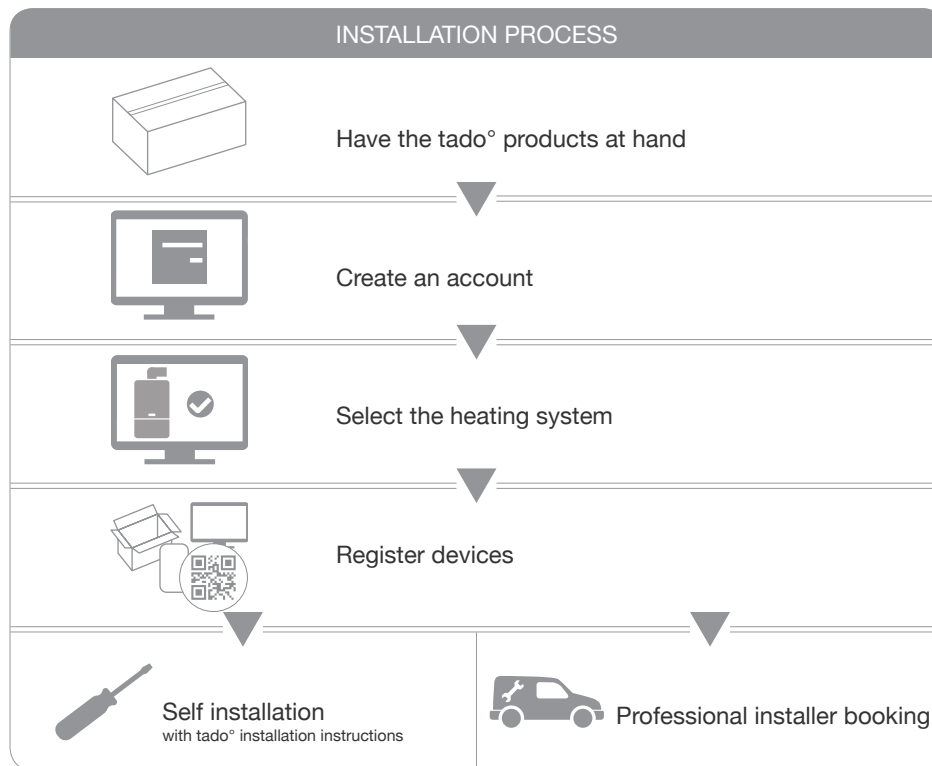

WARNING: While self installation of the tado° system is possible, tado° strongly recommends booking a professional installation through one of our tado° installation professionals.

Support



For online support, please visit:
support.tado.com



For phone support, please call:
UK: +44 (0)20 35144881
DE: +49 (0)89 416156640

Technical Specifications

tado° Smart Thermostat (Model RU01)

Dimensions: circa 104 x 104 x 19 mm (L x W x H) / circa 132 g
Operating voltage: 5-36V DC 0.2A / 4.5V DC (3xAAA batteries, 1,200 mA/h)
Battery Life (when operating on batteries) : ~ 2 years
Relay: max. 240V AC 6(4)A / max. 36V DC 6(4)A
Radio: 868 MHz, Mesh (6LoWPAN)
Display: 10 x 19 LEDs, 32 x 20 mm
Button: 1x Mechanical; 2x Capacitive Touch
Material: PC + ABS
Colour: white, matte

tado° Extension Box (Model BU01)

Dimensions: circa 102 x 150 x 28 mm (L x W x H) / circa 210 g
Operating Voltage: 5-36V DC 0.2A / 100-240V AC 0.2A
Relay: max. 240V AC 6(4)A / max. 36V DC 6(4)A
Radio: 868 MHz, Mesh (6LoWPAN)
Display: 1 x LED
Buttons: 1 x mechanical
Material: PC + ABS
Colour: white, matte

tado° Bridge (Model GW02)

Dimensions: circa 89 x 52.5 x 25.5 mm (L x W x H) / circa 61 g
Operating voltage: 5 V
Radio: 868 MHz, Mesh (6LoWPAN)
Material: PC + ABS
Colour: white, matte

Regulatory Conformity

EU Declaration of Conformity



tado° hereby declares that the tado° devices are in compliance with the essential requirements and other relevant provisions of the following EU Directives:

- Low Voltage Directive 2014/35/EU
- EMC Directive 2004/108/EC
- R&TTE Directive 1999/5/EC
- RoHS Directive 2011/65/EU

A copy of the EU Declaration of Conformity is available at: tado.com/conformity



The **WEEE symbol** means that the tado° devices must be disposed of separately from general household waste. When tado° devices reach the end of their lifespan, they must be taken to a designated waste collection point for safe disposal or recycling.

This conserves natural resources, protects human health and helps the environment