

INSTALLATION & USER INSTRUCTIONS

LED ELECTRIC FIRE



Focal Point Fires plc.
Christchurch, Dorset BH23 2BT
Tel: 01202 499330
Fax: 01202 499326
www.focalpointfires.co.uk
e : sales@focalpointfires.co.uk

MODELS COVERED BY THESE INSTRUCTIONS

NDY-19
LED INSET ELECTRIC FIRE

FRET AND FRAME OPTIONS AVAILABLE



MODEL SHOWN: BLENHEIM LED INSET ELECTRIC FIRE

Image used for illustration puposes only

3 YEAR GUARANTEE

SUBJECT TO TERMS & CONDITIONS

For details please see: www.focalpointfires.co.uk/tandcs or telephone
01202 588615

This product is only suitable for well insulated spaces or occasional use.

Please note : Except where otherwise stated, all rights, including copyright in the text, images and layout of this booklet is owned by Focal Point Fires plc. You are not permitted to copy or adapt any of the content without the prior written permission of Focal Point Fires plc.

**All instructions must be handed to the user
for safekeeping.**

Revision I - 12/18

© 2018 Focal Point Fires plc.

Section	Contents	Page No.	Section	Contents	Page No.
1.0	Preliminary Notes	2	8.0	Fitting the Decorative Frame and Front	6
2.0	Installation Requirements	3	8.1	Fitting the Loose Fuel Bed Options	7
3.0	Appliance Data	3	9.0	Operating the Appliance	7
4.0	Unpacking the Appliance	4	10.0	Safety Cut-Out System	11
5.0	Component Checklist	5	11.0	Cleaning and Maintenance	11
6.0	Installing the Appliance	5	12.0	Servicing	12
7.0	Removing the Appliance Spacer Frames	6	13.0	Guarantee - Terms and Conditions	12

I.0 PRELIMINARY NOTES

IMPORTANT - THESE INSTRUCTIONS SHOULD BE READ CAREFULLY AND RETAINED FOR FUTURE REFERENCE.

The appliance is designed for indoor use, and can be simply floor mounted in the majority of floor positions anticipated. It can be located in any household room, with the exception of bathrooms. Read all of the instructions before commencing installation. Retain for future reference and pass on as necessary to subsequent owners of the appliance.

- **DO NOT** use this appliance immediately below a fixed socket outlet.
- **DO NOT** use this appliance in an open flue.

When using this electrical appliance, basic precautions should be followed to reduce the risk of fire, electric shock and injury to person, including the following:

- This heater must be used on an AC supply only and the voltage marked on the heater's rating label must correspond to the supply voltage.
- **DO NOT** switch the appliance on until it is properly installed as described in this manual.
- This appliance can be used by children aged from 8 years and above and persons with reduced physical, sensory or mental capabilities or lack of experience and knowledge if they have been given supervision or instruction concerning use of the appliance in a safe way and understand the hazards involved. Children shall not play with the appliance. Cleaning and user maintenance shall not be made by children without supervision.
- Children of less than 3 years should be kept away unless continuously supervised. Children aged from 3 years and less than 8 years shall only switch on/off the appliance provided that it has been placed or installed in its intended normal operating position and they have been given supervision or instruction concerning use of the appliance in a safe way and understand the hazards involved. Children aged from 3 years and less than 8 years shall not plug in, regulate and clean the appliance or perform user maintenance.

• **CAUTION:** Some parts of this product can become very hot and cause burns.

Particular attention has to be given where children and vulnerable people are present.

- If the supply cord is damaged, it must be replaced by the manufacturer, its service agent or similarly qualified persons in order to avoid a hazard.
- The heater must not be located immediately below a socket-outlet.
- **DO NOT** use this heater in the immediate surroundings of a bath, a shower or a swimming pool, or other area where water/moisture could present a hazard.



- **WARNING:** In order to avoid overheating, do not cover the heater.
- **DO NOT** use this heater with a separate remote-control system or any other device that switches the heater on automatically, since a fire risk exists if the heater is covered or positioned incorrectly.
- **CAUTION:** In order to avoid a hazard due to inadvertent resetting of the thermal cutout, this appliance must not be supplied through an external switching device, such as a

timer, or connected to a circuit that is regularly switched on and off by the utility.

- Keep furniture, curtains and other fabric material away from the appliance.
- **DO NOT** leave the appliance unattended during use.
- From time to time, check the cord for damage. Never use the appliance if the cord or any part of the appliance shows signs of damage.
- **DO NOT** run the mains cable under carpets, rugs etc.
- **DO NOT** cover or obstruct the heater in any way. Overheating will result if it is accidentally covered.
- Never immerse the product in water or any other liquids.
- **DO NOT** use the appliance outdoors.
- Before cleaning the appliance, ensure it is unplugged from the power and that it is completely cool.
- **DO NOT** clean the appliance with abrasive chemicals.
- Never use accessories that are not recommended or supplied by the manufacturer. It could cause danger to the user or damage to the appliance.
- **DO NOT** insert or allow foreign objects to enter the inlet or outlet vents as this may result in electric shock, fire or damage to the appliance.
- **DO NOT** install the fire using an extension cord.
- Unplug from the mains supply if the appliance is not to be used for long periods.
- This product is only suitable for well insulated spaces or occasional use.

2.0 INSTALLATION REQUIREMENTS

This product is only suitable for well insulated spaces or occasional use. The appliance is supplied with a pre-wired three pin plug (13 Amp fuse rated) and 1.7 metres of electrical cable. It is therefore necessary for a suitable electrical socket to be located within this distance and be easily accessible. The appliance is suitable for installation into all proprietary surrounds with an opening of 406mm by 559mm (16" by 22"). The appliance is supplied fitted with 2 spacer frames enabling it to be fitted with no need for a recess into a wall or surround back panel. Both spacer frames have a depth of 57mm. The appliance can be fully recessed if the opening depth is 113mm or greater and neither spacer is used. It may be installed directly into any proprietary surround which can house this size of rebate, without the need to recess the appliance into a wall opening or fabricate a false chimney breast.

This appliance should be positioned on a firm level surface and in a clean 'dust free' environment. If the fire is to be sited in a fire surround then the suitability of the surround for use with electrical heaters should be established with the fire surround manufacturer.

If fitted into an open draught fireplace, it is recommended to blank off the chimney to reduce the risk of draught through the fire, which may cause the safety cut out system in the fan heater to operate.

- DO NOT**
- site in a position where curtains or drapes could cover the appliance.
 - site in a position where other soft materials could cover e.g. below a coat rack.
 - site behind an opening door where mechanical impact/damage could occur.
 - site where the supply cable would become a trip hazard.
 - sit, stand or forcefully pull on the appliance.
 - obstruct, cover or force items into the openings.
 - use the heater to dry clothes.
 - site/use in an outdoor location(s).
 - run the supply cable under carpets.
 - Mount on a wall.

3.0 APPLIANCE DATA

Weight (kg):	14 kg
Voltage (Volts):	220-240V a.c. 50Hz
Rated Power	2 x 900W/ 2 x 1000W
Supply Plug:	BS 1363, 13A Fused
Supply Cord:	1.7 Metres
Location:	Indoor Use
LED Display:	4 Watts

3.0 APPLIANCE DATA - CONTINUED

GB IE

All Models		NDY-19			
Item	Symbol	Value	Unit	Item	Unit
Heat output				Types of heat input, for electric storage local space heaters only	
Nominal heat output	P_{nom}	1.9	KW	Manual heat charge control with integrated thermostat	N/A
Minimum heat output (indicative)	P_{min}	0.95	KW	Manual heat charge control with room and/or outdoor temperature feedback	N/A
Maximum continuous heat output	$P_{max, c}$	1.9	KW	Electronic heat charge control with room and/or outdoor temperature feedback	N/A
Auxiliary electricity consumption				Fan assisted heat output	
At nominal heat output	e_{lmax}	0.014	KW	Type of heat output/room temperature control	
At minimum heat output	e_{lmin}	0.014	KW	Single stage heat output and no room temperature control	No
In standby mode	e_{lSB}	0.48	W	Two or more manual stages no temperature control	No
				With mechanical thermostat room temperature control	No
				With electronic room temperature control	No
				Electronic room temperature control plus day timer	No
				Electronic room temperature control plus week timer	Yes
				Other control options	
				Room temperature control with presence detection	No
				Room temperature control with open window detection	No
				With distance control option	No
				With adaptive start control	Yes
				With working time limitation	No
				With black bulb sensor	No
Contact details	Focal Point Fires, Avon Trading Park, Christchurch Dorset, BH23 2BT				

4.0 UNPACKING THE APPLIANCE

Read **all** the instructions before continuing to unpack or install this appliance. Carefully remove the appliance from its packaging and lay on the floor with its back surface downward. Note: DO NOT stand the appliance on its frame as this may cause distortion. Check that the remaining packaging contents correlate with the component checklist below. Please dispose of all packaging with care at your local recycling centre.

QUANTITY	DESCRIPTION
1	Heater main body
1	Remote control
1	Decorative frame
1	Decorative fret with ashpan door
1	Neoprene securing strip
1	Loose coal set (only available with Lulworth model)
1	Loose pebble set (only available with Lulworth model)
1	Instruction booklet
4	Magnets

6.0 INSTALLING THE APPLIANCE

Dependent on your installation requirements, you may wish to install the appliance in three different ways.



1: Flat wall - If you are putting the fire against a wall with no recess, you will use both of the spacers that are fitted to the fire. You will be able to use either the sticky double sided neoprene strips, or, secure the fire to the wall using the key hole slots on the rear of the spacer frame with screws.

2: Semi recessed - If you are putting the fire against a wall with a recess of 60mm or more, you will be able to remove one of the spacers that are fitted to the fire, so that your fire can sit further back on the hearth. You will be able to use either the sticky double sided neoprene strips, or, secure the fire to the wall using the key hole slots on the rear of the spacer frame with screws. **See section 7.0 Removing the appliance spacer frame.**

Method 1 - Installation with spacer(s)

Neoprene - To use the Double sided Neoprene strip, you will need to cut the length into three equal pieces. Install one either side of the bottom rear of the spacer and one on the top center of the spacer. **This is not recommended for cast frame models.**

Method 2 - Screw fixings

Using suitable fixings for your wall or surround, mark the centre of your opening and measure 227mm to the left and then again to the right. From there measure from the floor 304mm up the wall. This will be the centre of the screw. Fit the screws leaving a 2mm gap.

Once you have fitted the screws in place, offer the fire up to the hearth and lift the fire by a small amount to locate the two keyhole slots on the back of the fire over the screws. When you lower the appliance, it will now be locked in place. **This is recommended for cast frame models.**

Method 3 - Fully recessed

If you are putting the fire against a wall with a recess of 120mm or more, you will be able to remove both of the spacers that are fitted to the fire, so that your fire can sit further back on the hearth. To secure the fire to the wall you will be able to use the key hole slots on the rear of the fire with screws. **See section 7.0 Removing the appliance spacer frames.**

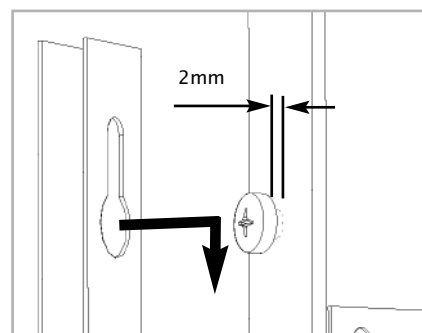

6.0 INSTALLING THE APPLIANCE - CONTINUED

GB IE

Neoprene - To use the double sided Neoprene strips, you will need to cut the strip into four pieces to fit on the large and small brackets on the back of the appliance.

Screw fixings - Using suitable fixings for your wall or surround, mark the centre of your opening, measure 216mm to the left and then again to the right. From there measure from the floor 562mm up the wall. This will be the centre of the screw.

Once you have fitted the screws in place, offer the fire up to the hearth and lift the appliance onto the fixing points.



7.0 REMOVING THE APPLIANCE SPACER FRAMES

Tools required: Cross headed screwdriver.

Step 1: Ensure the appliance is disconnected at the supply socket before undertaking the required work.

Step 2: Remove the six screws from the rear spacer located at the rear of the appliance.

Step 3: Remove the outer spacer frame.

Step 4: To remove the second spacer unscrew four screws using same method used in steps 1, 2 & 3.



8.0 FITTING THE DECORATIVE FRAME AND FRONT

The appliance may be supplied with a decorative frame in a variety of finishes.

IMPORTANT : Due to the possibility of sharp edges, care should be taken when handling the frame components. The use of protective gloves is recommended.

If not pre-fitted, and the appliance is supplied with a one piece decorative frame that is attached to the front of the firebox with the magnets provided. Place the decorative firefront in front of the fire and slide the ashpan door into place. The firefront shown in these instructions may be different to the one supplied with the appliance.

For three piece frames :The side pieces of the clip on assembly should be pushed into position first, followed by the top bar, which overlap the sides.

Cast frame models: Remove the decorative frame from it's protective packaging. The frame is retained onto the firebox with a mounting bracket at the top of the frame and three magnets on each leg of the frame.

8.1 FITTING THE LOOSE FUEL BED OPTIONS

GB IE



IMPORTANT: Loose fuel bed options are only available with the Lulworth model.

The Lulworth LED inset electric fire has the option of either a real coal or pebble fuel bed. Simply remove the coals or pebbles from their packaging and position the coals or pebbles onto the plastic fuel bed.



9.0 OPERATING THE APPLIANCE

Standby status:

The fire displays the standby symbol  and timer symbol  (There is no timer symbol if there is no time set or the  button on remote control at the OFF position)

On status

The fire displays the day/time, room temperature and flame brightness level. Please set the actual day/time when first used.

Instructions for Use

- The fire can be operated either by the switches located on the left and right hand sides of the canopy or by supplied remote control.

Manual Operation

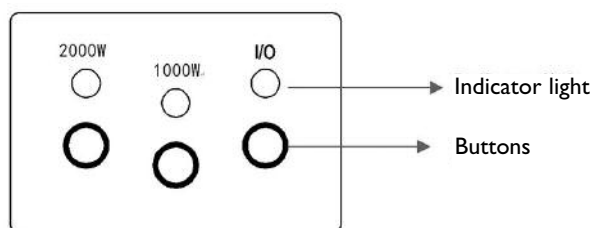

- The standby switch is located on the left hand side of the canopy and the control switches are on the right. The standby switch must be switched on.
- Press the O/I button once to turn the fire and flame effect on. A red indicator light will appear to indicate that the function is ON. Press the O/I button for 3 seconds, this will operate the flame brightness setting. Hold the button down until the desired flame brightness is obtained, there are 5 different flame brightness levels available.
- Press the 1000W button once for the low heat settings; press twice to switch the heat setting off.
- Press the 2000W button once for the high heat settings; press twice to switch the heat setting off.

Remote Operation

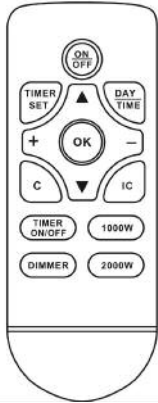

Battery Replacement

Battery Requirements: 2x AAA 1.5V

1. Remove the battery bracket and the used batteries from the back of the remote control.
2. Insert the 2x replacement batteries the correct way into the battery holder, making sure the batteries are firmly seated.
3. Then insert the battery bracket back into position.

- The standby switch is located on the left hand side of the canopy, this must be switched on.
- Wait for the receiver to respond to the transmitter. **DO NOT PRESS** the buttons more than once within two seconds for correct operation.

• Flame brightness adjustment operations

- Press the **DIMMER** button to set the desired flame brightness, there are 5 different flame brightness levels available.

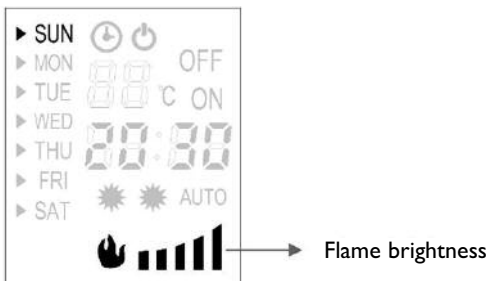

• Temperature setting operations

- Press the + button to increase to the desired temperature; press the – button to decrease to the desired temperature. The temperature ranges from 15°C to 30°C.

• **Note:** The set temperature must be higher than the room temperature for the heater to operate.

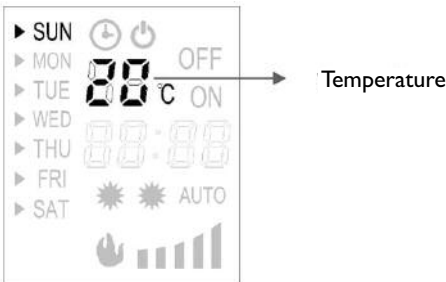

• Heating operations

- Press the ON/OFF button once on the remote control to turn the fire and flame effect ON/OFF.
- Press the 1000W button for the low heat settings; press twice to switch the heat setting off .
- Press the 2000W button for the high heat settings; press twice to switch the heat setting off.
- **Note:** The set temperature must be higher than the room temperature for the heater to operate.

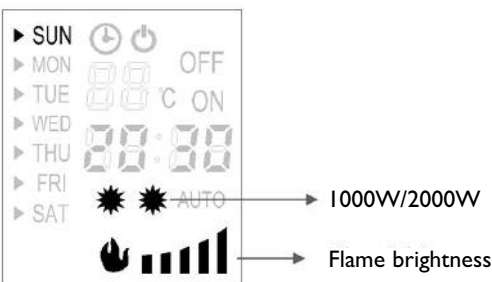

Automatic heating operations (Intelligent Control)

- Press the IC button once to turn the automatic heat setting on; press twice to turn the automatic heat setting off.
- The fire displays the **AUTO** symbol when the automatic heating status is activated. The fire will adjust the heat settings between 1000W and 2000W automatically according to the room temperature and the appliance temperature settings.
- Note:
 - The appliance may turn the heating on automatically prior to the set time (Maximum 20 minutes prior to the set time)
 - The set temperature must be higher than the room temperature for the heater to operate.

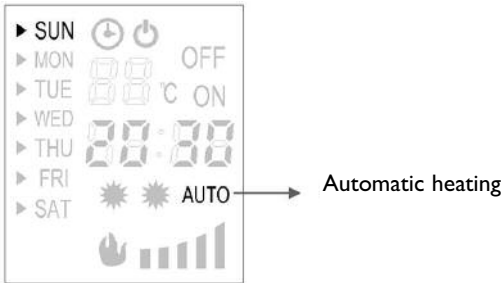

Day and Time setting operations

- This is operated by supplied remote control.
- Press the DAY/TIME button first.
- Press the ▲ button or the ▼ button to select the day (SUN to SAT from top to bottom) and press DAY/TIME button to finish.
- Continue to press the + button or the – button to set the hour and press DAY/TIME button to finish.
- Continue to press the + button or the – button to set the minute.
- Press the OK button to finish the day and time settings.

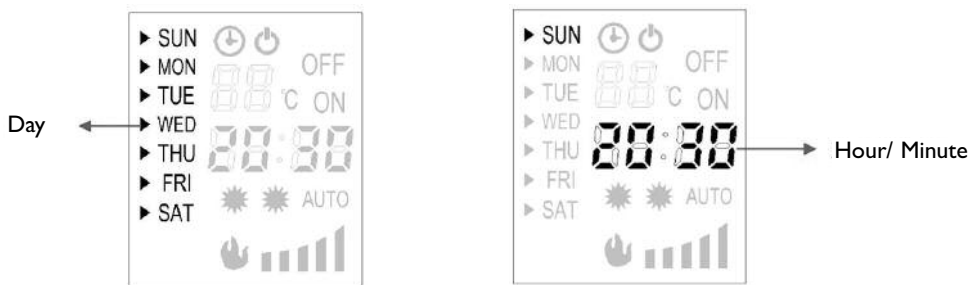

Timing setting operations

Timing instructions

- This is also operated by the remote control supplied.
- 10 timing cycles Maximum.
- Each timing cycle has a day Timer ON time and Timer OFF time.
- Each timing cycle has a maximum of 23 hours and 50 minutes
- Each timing cycle is either a day of the week or several day of the week. For example, either only set time for Monday or set timings for Monday, Friday and Sunday together.

Browse timing records

- Press the TIMER SET button first.
- Press the + button or the – button to browse the Timer ON times one by one. (A maximum of 10 Timer ON times from 01 to 10)
- Press the ▲ button first and then press the + button or the – button to browse the Timer OFF times one by one. (Maximum 10 Timer OFF times from 01 to 10)
- Press the C button to cancel the Timer ON times or Timer OFF times.

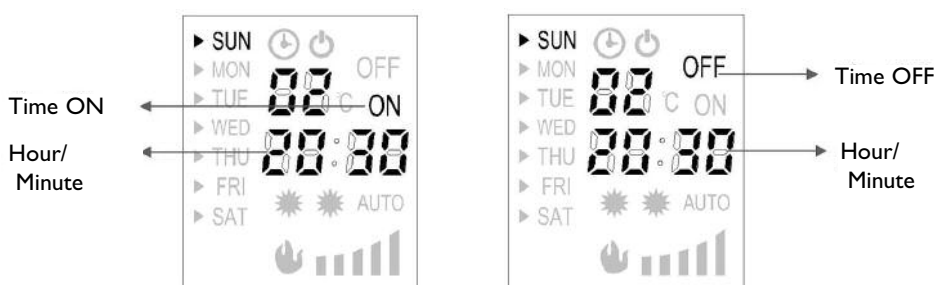

Timing setting procedures

- Press the TIMER SET button, and the sequence number starts to blink.
- Press the + button or the – button to select the sequence number from 01 to 10 and press the TIMER SET button to finish.

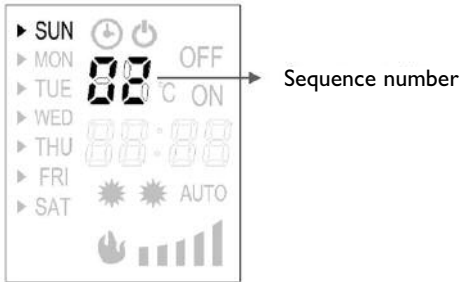

① SELECT DAY

- Continue to press the ▲ button or ▼ button to select the corresponding date from SUN to SAT, then press the + button to add the corresponding date or press the - button to delete the corresponding day. Press the TIMER SET button to finish the day setting. (A day timing setting)
- Continue to press the ▲ button or ▼ button to select the corresponding day from SUN to SAT, then press the + button to add the corresponding day, then press the ▲ button or ▼ button again to select another corresponding day and press the + button to add the corresponding day, same operations to add other corresponding days. Or press the - button to delete the corresponding day, then press the ▲ button or ▼ button again to another corresponding day and press the - button to delete the corresponding day, same operations to delete other corresponding days. Press the TIMER SET button to finish the day setting. (Several day timing setting)

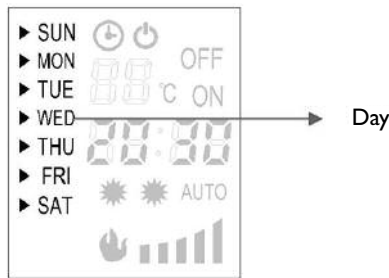

② SET TIMER ON TIME

- Continue to press the + button or the – button to set the hour (Timer ON) and press the TIMER SET button to finish.
- Continue to press the + button or the – button to set the minute (Timer ON) and press the TIMER SET button to finish.

NOTE:The ON symbol extinguishes and the OFF symbol illuminates.

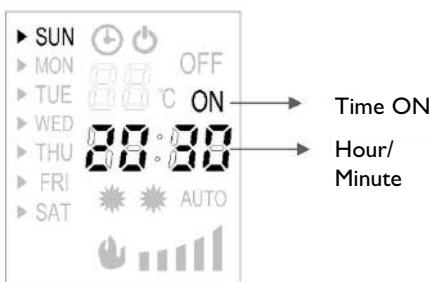

③ SET TIMER OFF TIME

- Continue to press the + button or the – button to set the hour (Timer OFF) and press the TIMER SET button to finish.
- Continue to press the + button or the – button to set the minute (Timer OFF) and press the TIMER SET button to finish.

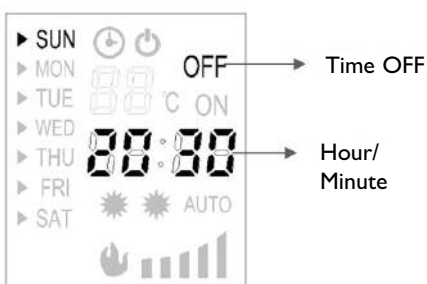

④ SET TEMPERATURE

- The temperature set starts blinking. Continue to press the + button or the – button to set desired temperature from 15°C to 30°C. The default temperature is 25°C.
- Press the OK button to finish.

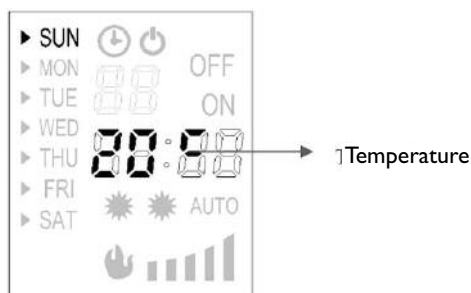

IMPORTANT NOTE:

- Continue to press the 1000W button or 2000W button, or IC button to activate the heater when timer is ON after finishing the timing setting. The fire only has flame effect working if you have not selected the desired heat.
- The set temperature must be higher than the room temperature for the heater to operate.
- You can continue to set 02, 03, 04... timing cycles repeat the same procedures after the 01 timing cycle is finished.

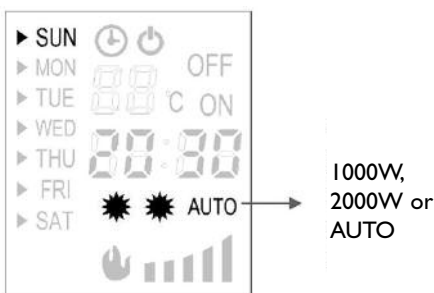

TIMER ON/OFF operations

- Press the TIMER ON/OFF button to turn on or turn off the timing settings.
- Disconnect the fire from the supply, the timing settings are still retained, but the current day and time must be reset.

10.0 SAFETY CUT-OUT SYSTEM

This appliance has a safety cut-out system fitted which will activate if the air inlets or heater outlets are obstructed. For safety reasons the fire **WILL NOT** switch on again automatically.

The following procedure must be carried out before the fire can be operated again:

1. Unplug the power supply cable at the outlet socket and place all switches to off at the appliance.
2. Leave the fire OFF for a period of not less than 15 minutes, ensuring any obstructions are removed.
3. Plug in the power supply cable at the outlet socket, and then switch on at the appliance.

If the appliance fails to operate correctly, repeat the above procedure. If an attempt to switch on is made before the safety cut-out has reset, the heaters may cut-out for a further period of time. If the sequence has been followed correctly and the heaters still fail to function, check the power supply cable plug is plugged in at the outlet socket. If this is not the cause, call an electrician.

11.0 CLEANING AND MAINTENANCE

ALWAYS DISCONNECT THE APPLIANCE AT THE SUPPLY OUTLET SOCKET BEFORE UNDERTAKING ANY CLEANING.

Except for periodic cleaning of dust, there are no specific requirements for care, other than regular cleaning of the general appliance. A wipe with a dry cloth is normally sufficient. DO NOT use abrasive cleaners as they can damage the finish. Make sure the heater outlet grille (located next to the switches) are kept clear of dust, pet hair and other airborne household matter. These should be vacuum cleaned periodically using a brush attachment.

The LED light strip is designed and tested to last 20,000 hours however, should a problem occur with the LED light strip this can be replaced. The LED light strip can be purchased from Focal Point Fires (please see contact details on front cover). The light strip will be supplied with fitting instructions.

Battery Replacement

Battery Requirements: 2x AAA 1.5V

1. Remove the battery bracket and the used batteries from the back of the remote control.
2. Insert the 2x replacement batteries the correct way into the battery holder, making sure the batteries are firmly seated.
3. Then insert the battery bracket back into position.

There are no internal user serviceable parts.

Check regularly for security of wall fixings as appropriate. Also check security of supply cable and connections. If the supply cable becomes damaged, it must be replaced by a service agent or competent person, such as a qualified electrician.

This appliance is supplied with a BS1363 3 pin plug fitted with a 13 Amp fuse. Should the fuse require replacing, it must be replaced with a fuse rated at 13 Amp and approved to BS1362. In the event of the mains plug being removed/ replaced for any reason, please note : **IMPORTANT:** The wires in the mains lead are coloured in accordance with the following code:

Blue - Neutral

Brown - Live

Green/ Yellow - Earth

As the colours of the wires in the mains lead of this appliance may not correspond with the colour markings identifying the terminals in your plug, proceed as follows.

The blue wire must be connected to the terminal marked with an N or coloured black.

The brown wire must be connected to the terminal marked with an L or coloured red.

The green/yellow wire must be connected to the earth terminal which is marked with an E or with the earth symbol. **WARNING:** Never connect live or neutral wires to the earth terminal of the plug.

NOTE: If a moulded plug is fitted and has to be removed take great care in disposing of the plug and severed cable, it must be destroyed to prevent engaging into a socket.

Refer to Section 2.0, Appliance Data for fuse specification. Excluding fuses, use only genuine manufacturers spare parts available from your supplier.

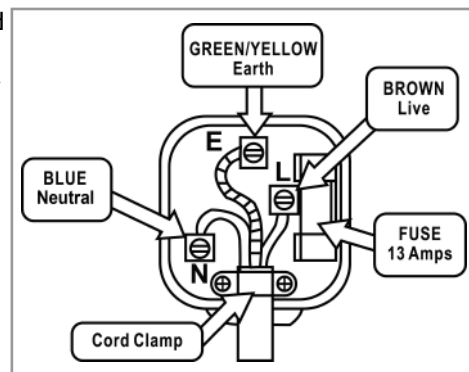

13.0 GUARANTEE - TERMS AND CONDITIONS

Registration is not required.

The 3 year guarantee only covers products purchased on or after 1st February 2009. The 3 year guarantee commences from the date of purchase, provided that the following 3 terms and conditions are adhered to:

1. For any claim to be made within the 3 years from date of purchase you will be required to provide and supply us with your proof of purchase.
2. Your gas fire must have been commissioned by a Gas Safe registered installer, evidence of which you must provide together with the Gas Safe registration number.
3. Your appliance must have been serviced annually, irrespective of use, by a Gas Safe registered installer, evidence of which must be provided, such as the receipt.

Please note all consumable items such as any ceramics including coals, pebbles, matrix, front strips, panels and bulbs are not covered by the 3 year guarantee.

We reserve the right to reject any claim or make a charge for any visit where the cause of the defect is due to non-compliance with the installation and/or servicing instructions or misuse of the appliance.

If a repair is chargeable during the warranty period, we will inform you and where possible, provide a quote or price guide before starting work. We cannot always give a firm cost until we commence the repair as it is not always possible to identify which components have been damaged.

Repaired or replaced products are covered only for the remainder of the original guarantee period and the guarantee period will not be extended even if we repair or replace any product or part.

If we replace any component or product, the component or product removed will become our property.

We will not accept or reimburse the cost(s) of any third party who undertakes any work carried out on the product or fits parts, unless we have approved such work in advance of it being carried out.

The Manufacturer's guarantee does not apply to:

- Damaged caused by faulty installation, theft, tampering, neglect, misuse, normal wear and tear, accident, fire, flood, explosion, lightning, storms, frost or other bad weather conditions.
- Damage caused by the non-observance of the Manufacturer's Installation Instructions.
- Any unauthorised adjustments made to the product by a third party.
- Servicing and its associated costs.
- Self-maintenance tasks such as cleaning.

Making a claim is easy.

If you wish to make a claim under our 3 year guarantee, and all of the terms and conditions for your product have been met then please submit the following information for the attention of the 3G Service Department to 3g@focalpointfires.co.uk. Alternatively, you can fax to 01202 499326 or post to Focal Point Fires plc, 3G Service Department, Reid Street, Christchurch, Dorset, BH23 2BT. Please note that this does not affect your statutory rights.

Details required:

1. Name, full address (including post code) and contact telephone numbers.
2. Receipt of purchase or credit card statement.
3. Original installer's Gas Safe* registration number (gas fires only).
4. Annual service receipt for every 12 months (gas fires only).



Waste electrical products should not be disposed of with household waste. Please recycle where facilities exist. Check with your local authority or retailer for recycling advice.

As our policy is one of continuous improvement and development, we therefore hope that you will understand we must retain the right to amend details and/or specifications without prior notice.