

CUSTOMER SERVICE

Guarantee

Your product has the benefit of our manufacturer's guarantee which starts from the date of purchase.

To activate this guarantee, please return your completed registration card, visit our website or free phone 0800 0731248 within 30 days of purchase (UK only).

Within the guarantee period we will resolve defects in materials or workmanship, free of charge, by repairing or replacing parts or product as we may choose.

If you have not previously activated the guarantee, you will be required to do so prior to the provision of assistance. If you do not activate your guarantee our Engineer will be entitled to charge full payment for the visit (Call out fee plus parts).

This guarantee is in addition to your statutory rights and is subject to the following conditions:

- The product must be installed and maintained in accordance with the instructions given in this user guide.
- Servicing must only be undertaken by us or our appointed representative. **Note!** if a service visit is required the product must be fully installed and connected to services.
- Repair under this guarantee does not extend the original expiry date. The guarantee on any replacement parts or product ends at the original expiry date.
- For shower fittings or consumable items we reserve the right to supply replacement parts only.

The guarantee does not cover:

- Call out charges for non product faults (such as damage or performance issues arising from incorrect installation, improper use, lack of maintenance, build up of limescale, frost damage, corrosion, system debris or blocked filters) or where no fault has been found with the product.
- Water or electrical supply, waste and isolation issues.
- Compensation for loss of use of the product or consequential loss of any kind.
- Damage or defects caused if the product is repaired or modified by persons not authorised by us or our appointed representative.
- Routine maintenance or replacement parts to comply with the requirements of the TMV 2 or TMV 3 healthcare schemes.

What to do if something goes wrong

If your product does not function correctly when you first use it, contact your installer to check that it is installed and commissioned in accordance with the instructions in this manual. Should this not resolve the issue, contact our Customer Services Team who will offer you or your installer advice and if applicable arrange for a Service Technician to call. If the performance of your product declines, check in this manual to see if simple home maintenance is required. If you require further assistance call our Customer Services Team.

Extended Guarantees

A selection of protection plans are available that enable you to cover repair bills for the life of your policy (excludes Eire). Ring 01922 471763 for more details.

Helpdesk Service

Our dedicated Customer Services Team is comprehensively trained and can offer help and advice, spare parts, accessories or a service visit. We will need you to have your model name or number, power rating (if applicable) and date of purchase. As part of our quality and training programme calls may be recorded or monitored.

Mira Showers Website (www.mirashowers.co.uk)

From our website you can register your guarantee, download additional user guides, diagnose faults, purchase our full range of accessories and popular spares, refer to our FAQ's and request a service visit.

Spares and Accessories

We maintain extensive stocks of genuine spares and accessories and aim to provide support throughout the product's expected life. Payment can be made by phone at time of order using most major Credit or Debit cards and we aim to despatch orders within two working days. Items purchased from us are guaranteed for 12 months from date of purchase. For safety reasons spares exposed to mains voltages should only be fitted by competent persons.

Returns – items can be returned within one month of date of purchase, providing that they are in good condition and the packaging is unopened. Please obtain authorisation from our Customer Services Team before return. We reserve the right to apply a 15% restocking charge.

Service / Repairs

We have a nationwide team of Service Technicians who can carry out all service or repair work to your product within the guarantee period and beyond. You have the assurance of a fully trained Mira Technician, genuine Mira spare parts and a 12 month guarantee on any chargeable work done.

Payment should be made directly to the Service Technician who will accept most major Credit or Debit cards.

To Contact Us

UK

Telephone: 0844 571 5000

www.mirashowers.co.uk

E-mail: technical@mirashowers.com

Fax: 01242 282595

By Post: Mira Customer Services Dept, Cromwell Road, Cheltenham, Gloucestershire, GL52 5EP

Eire

Telephone: 01 459 1344

E-mail: sales@modernplant.ie

Fax: Dublin 01 459 2329

By Post: Modern Plant Ltd (Dublin),

Otter House, Naas Road, Clondalkin, Dublin 22

MIRA BEAT SHOWER FITTINGS

mira
SHOWERS

Introduction

Thank you for purchasing a quality Mira product. To enjoy the full potential of your new product, please take time to read this guide thoroughly, having done so, keep it handy for future reference.

Mira shower fittings are designed to give a satisfactory shower over a range of pressures. These fittings are suitable for pressures between 0.1 and 5.0 bar.

General

1. Make sure that the shower fittings are installed by a competent installer.
2. Installations must comply with Water Regulations (Bye-Laws, Scotland), and any other Local Regulations and Building Regulations in force at the time of installation.
3. Before installation carefully inspect the new fixture for any signs of damage.
4. The shower fittings should be positioned at a convenient height for all the family. Position the fittings to spray across rather than towards the opening of the cubicle and also away from the shower control. Avoid layouts where the shower hose will be sharply kinked. This may reduce the life of the hose.
5. A hose retaining ring is supplied to prevent the handset from dropping below the spill over level of the bath or shower, which could lead to contamination from back-siphonage. The supplied hose retaining ring should meet the great majority of user requirements for shower installations with flexible outlet fittings.
However, there will be occasions when the hose retaining ring will not provide a suitable solution. In these instances an **outlet double check valve**, e.g. the Mira DCV-H, **must** be fitted. The inclusion of the Mira DCV-H will increase the required supply pressure typically by 0.1 bar.

6. **Do not** fit any form of flow control in the outlet pipe work if the shower fittings are installed in conjunction with a product that requires the fittings to act as a vent (e.g. an electric shower).
7. Special consideration should be given to the fixing arrangements when installing onto a dry lined, stud partition, shower cubicle or laminated panel wall structures. Installers may wish to obtain alternative proprietary cavity fixings, or choose other options, however, these methods of fixing are beyond the scope of this guide.

Cleaning

Many household cleaners contain abrasives and chemical substances, and should not be used for cleaning plated or plastic fittings.

These finishes should be cleaned with a mild washing up detergent or soap solution, and then wiped dry using a soft cloth.

Use your thumb or a soft cloth to wipe any limescale from the soft nozzles and the front surface of the handset spray plate.

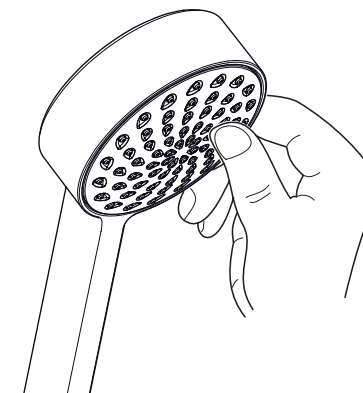

Spare Parts

Spare part numbers are indicated in bold and are available from authorised stockists or merchants (locations on request) or direct from Mira Customer Services, our contact details can be found on the back cover of this guide.

Mira is a registered trade mark of
Kohler Mira Limited.

The company reserves the right to alter
product specifications without notice.



MIRA BEAT SHOWER FITTINGS

Shower Fittings Installation

1. Mark the wall fixing hole positions and drill two holes to suit the wall fixings.

Note! For new installation optimum fixing centres 580 mm. Replacement installation fixing centres 620 mm maximum.

2. Install the wall plugs and mounting brackets and secure with the screws. Check vertical alignment.

Note! The mounting brackets are slotted to aid adjustment.

3. Install the clamp bracket and the slide bar supports (and the hose retaining ring if supplied) onto the slide bar.

4. Ensure the slide bar clamping screws are flush with the inside edge of the slide bar supports. Fit the slide bar supports over the mounting brackets, then adjust the slide bar vertically ensuring an equal length of slide bar protrudes from the top and bottom mounting bracket.

5. Remove the slide bar assembly carefully, preventing any further movement between the slide bar and slide bar supports.

6. Tighten the two slide bar clamping screws no more than 1/2 turn to secure the slide bar supports to the slide bar.

Caution! Overtightening these screws will cause damage.

7. Install the slide bar assembly onto the mounting brackets. Tighten the 2 x M4 screws with the supplied 3 mm hexagonal key.

Caution! Do not force assembly on to the mounting brackets, re-align a slide bar support if required.

Soap Dish Installation

Note! The following instructions are for models supplied with a soap dish.

1. Install the taper block onto the soap dish.
2. Install the soap dish screw into the taper block.
3. Install the soap dish assembly into the slide bar and tighten the soap dish screw.

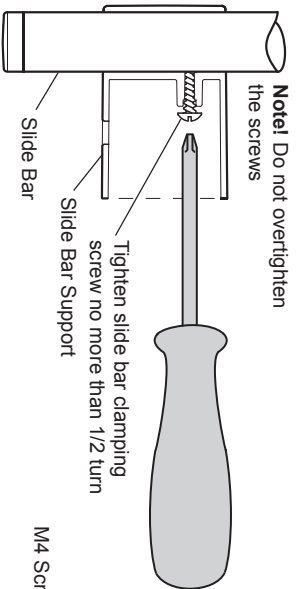

Note! Do not overtighten the screws

Tighten slide bar clamping screw no more than 1/2 turn

Slide Bar Support

M4 Screws 'A' (x2)

Cap (x2)
1703.196

Note! Ensure an equal length of slide bar top and bottom

Mounting Bracket

Slide Bar Support (x2)
(Includes screws)
1703.200 (White)
1703.201 (Chrome)

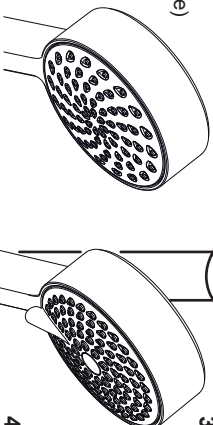

4. Ensure the slide bar clamping screws are flush with the inside edge of the slide bar supports.

Shower Handset
1703.351 (Single Mode - Chrome)
1703.352 (Single Mode - White)
1703.353 (Multi Mode - Chrome)
1703.354 (Multi Mode - White)

Slide Bar Clamping Screw



Hose Seal (x2)
632.73

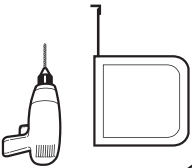

Clamp Bracket
1703.203 (Chrome)
1703.202 (White)

Slide Bar
1703.204 (660 mm)
1703.205 (680 mm)

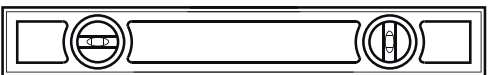

Slide Bar Support

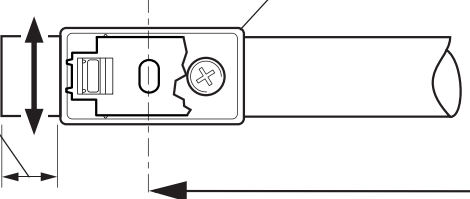

Note! Ensure an equal length of slide bar top and bottom

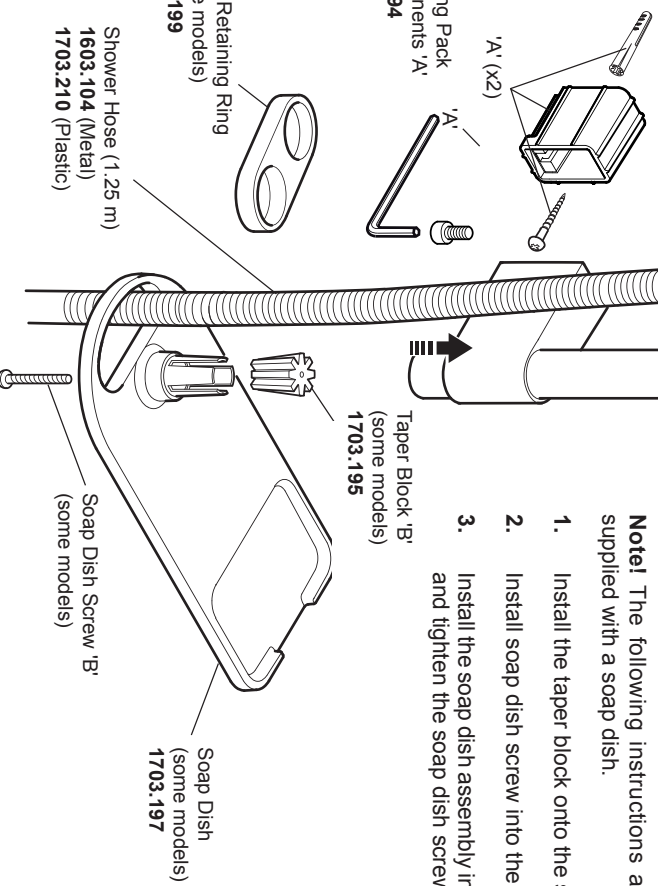

Mounting Pack Components 'A'
1703.194

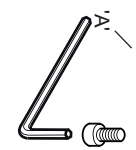

Taper Block 'B'
(some models)
1703.195

Hose Retaining Ring
(some models)
1703.199



Shower Hose (1.25 m)
1603.104 (Metal)
1703.210 (Plastic)

Soap Dish Screw 'B'
(some models)

Soap Dish
(some models)
1703.197