

# Easy Fit SmartPhone alarm system (EF-IPBox)

## Installation · Programming · Operating

Keep this manual safe for reference and future maintenance

---

### Introduction

---

Thank you for choosing the Yale Wireless Alarm System. This simple to install system has been designed with the user in mind.

All the components are self contained and no connections are needed between the units. There is no need to damage the home decor, lift carpets or run cables.

You can install up to 20 devices in this system. As well as extra door/window contacts, PIRs and smoke detectors, you can add keyfob remote controls and keypads for added control convenience.

There is no need to wire into the mains supply or seek the services of a qualified electrician. The control box is powered by an adaptor and all other components are powered by battery (all batteries included). Batteries will operate for 2 years or more before they need changing. Regular testing and battery changes (when notified by the system) will ensure reliability and peace of mind.

The security detectors and external siren are 'tamper' protected. Any unauthorised tampering with these items when the system is armed will result in an alarm.

Display extreme caution when using ladders or steps, please follow manufacturer's instructions. Be careful when using hand and power tools and follow the manufacturer's guidelines when using them. Take care that the correct tools are used. Wear goggles or protective clothing where required.

The external Siren is extremely loud, please ensure you replace the cover and retreat to a safe distance before testing.

The dialling facilities must only be used with persons who have consented to being contacted by the system. The system is not to be used to make 999 emergency calls directly. Yale do not hold responsibility for any actions taken by emergency services for incorrect use of the dialling facility.

#### Special Notes on Compatibility:

This alarm system is NOT compatible with SmartHome Alarm, HSA6000 series and HSA3000 series accessories. Please note the prefix "**EF-**" on the front of the part number to indicate compatibility. It is also compatible with accessories labelled "For use with SmartPhone alarm only".

### Contents

---

<b>1 Location planning</b>	2
<b>2 Unpack all the parts</b>	4
<b>3 Initial set-up</b>	6
<b>4 Mounting Devices</b>	8
<b>5 Using the System</b>	11
Adding and using Accessories	13
Changing the batteries	15
Troubleshooting	17
Specifications	18

### Recommended Installation Sequence

We recommend you follow the simple install sequence, headings numbered **1-5**.

Information and illustrations are subject to change within this document. Yale reserves the right to alter the specification and product design at anytime without notice. Yale® is a registered trademark. © 2013 ASSA ABLOY. All rights reserved.

# 1 Location planning

Work out the best places to locate the devices for maximum protection. Having chosen the locations do not mount at this stage.

## Home and Away Mode Planning

The home arming mode allows the premises to be part armed so that no one can get inside without warning the occupier, yet the person already inside the house can move freely without triggering the alarm. For example the downstairs of a house can be armed while upstairs can be disarmed allowing the user to go to bed without causing an alarm.

**If this feature is to be used, then it should be planned now, before installation.**

Decide what areas can be occupied when in home arming mode, the sensors for these areas should have its attribute set to "Home Omit" (see page 11); and the sensors activated on the path to access the control unit should be to be set to Home access.

## Operating Range

All devices must be within 30 metres of the control unit and must not be mounted on or near large metal objects. Avoid obvious sources of electrical interference such as fridges and microwave ovens.

## Tamper Switches

When mounting devices ensure that any tamper switches close fully. On uneven surfaces it may be necessary to place packing behind the switch for reliable operation.

## Extend the System

Extend the system in the future to increase your security or as your needs change. For example, add extra PIR detectors and extra door/window contacts.

## Choosing Location

To minimise interference, avoid locating devices close to metal framework, glass, electrical appliances (especially wireless devices) and electric cables.

Please note that the presence of high density material (metal, glass etc) in the transmission path will significantly reduce the wireless transmission range.

### Keypad Remote Control Accessory

When used as second keypad, it is ideal in bedrooms or at the top of a stairwell so the ground floor can be armed when going to bed for the night. Or, at a side or back door for alternative entry.

- Mount at chest height for ease of use
- Designed for indoor use only
- Keypad should be accessible from a protected entry/exit point
- Ensure that the keypad is not visible from the outside of the premises.

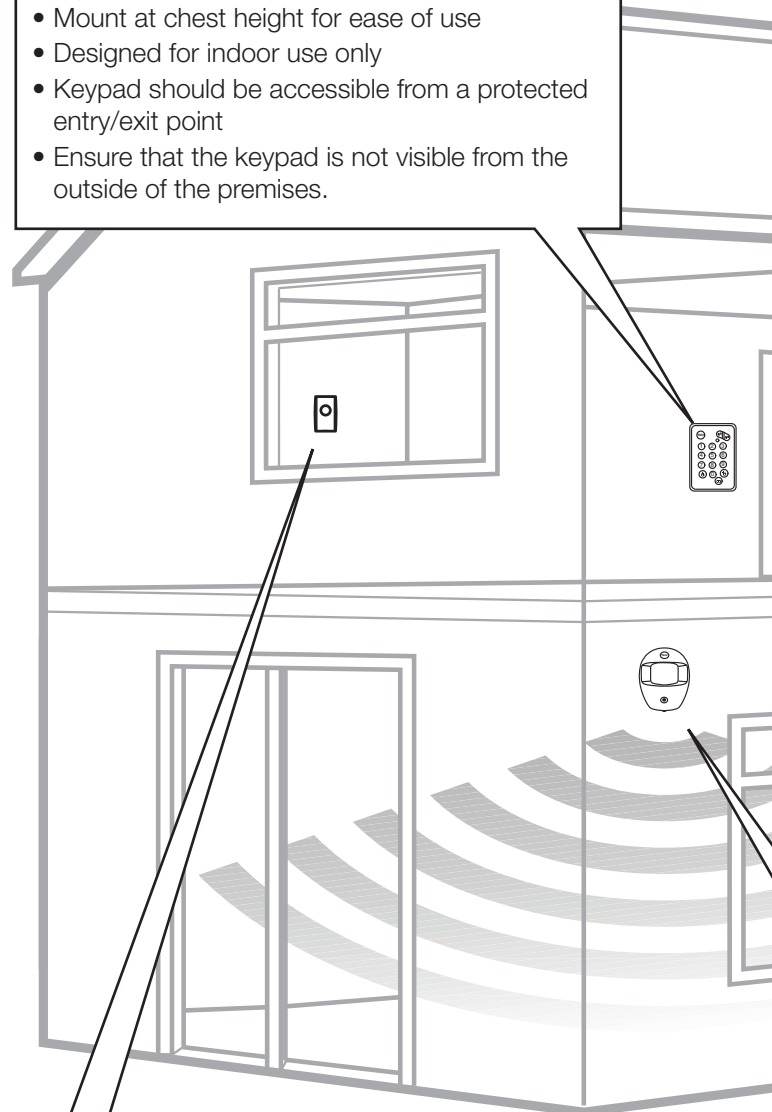

### Help Button Accessory

The help button provides extra protection for you and your family. When help is needed the button can activate your alarm immediately - even when the system is disarmed.

- Mount on flat wall surface
- Designed for indoor use only
- Out of reach of children
- Hidden from view while easily accessible.

### Smoke Detector

- Mount in the middle of the ceiling at the top of a stairwell, or on the centre of hallway ceilings where smoke would most likely be detected.
- Do not mount in corners or above cooking appliances and heaters.
- Install additional detectors if there are closed doors preventing smoke from reaching detectors.

### Siren

Choose a position on an external wall where the siren would be most prominent. Mount as high as possible, out of easy reach.

### Door/Window Contact

Select a door that will be the main point of entry and exit, usually your front door.

- Mount as high as possible
- Do not aim a PIR at this door or window

### Keyfob Remote Control Accessory

Can be used inside or outside the property and can be kept on your keyring.

### PIR Movement Detector or PIR Camera

- Mount in a position such that an intruder would normally move across the PIRs field of view.
- Height should be between 1.9 and 2 metres above floor level.
- Location in a corner will ensure wider room coverage.
- Do not mount the PIR where its field of view will be obstructed e.g. by curtains, ornaments etc.
- Do not point directly at sources of heat e.g. fires or boilers, and do not position directly above radiators.
- Avoid mounting the PIR directly facing a window.
- Do not point the PIR at a door protected by a door/window contact.

### Control Box

- Ensure it is hidden from view.
- Access to mains socket and broadband internet router.

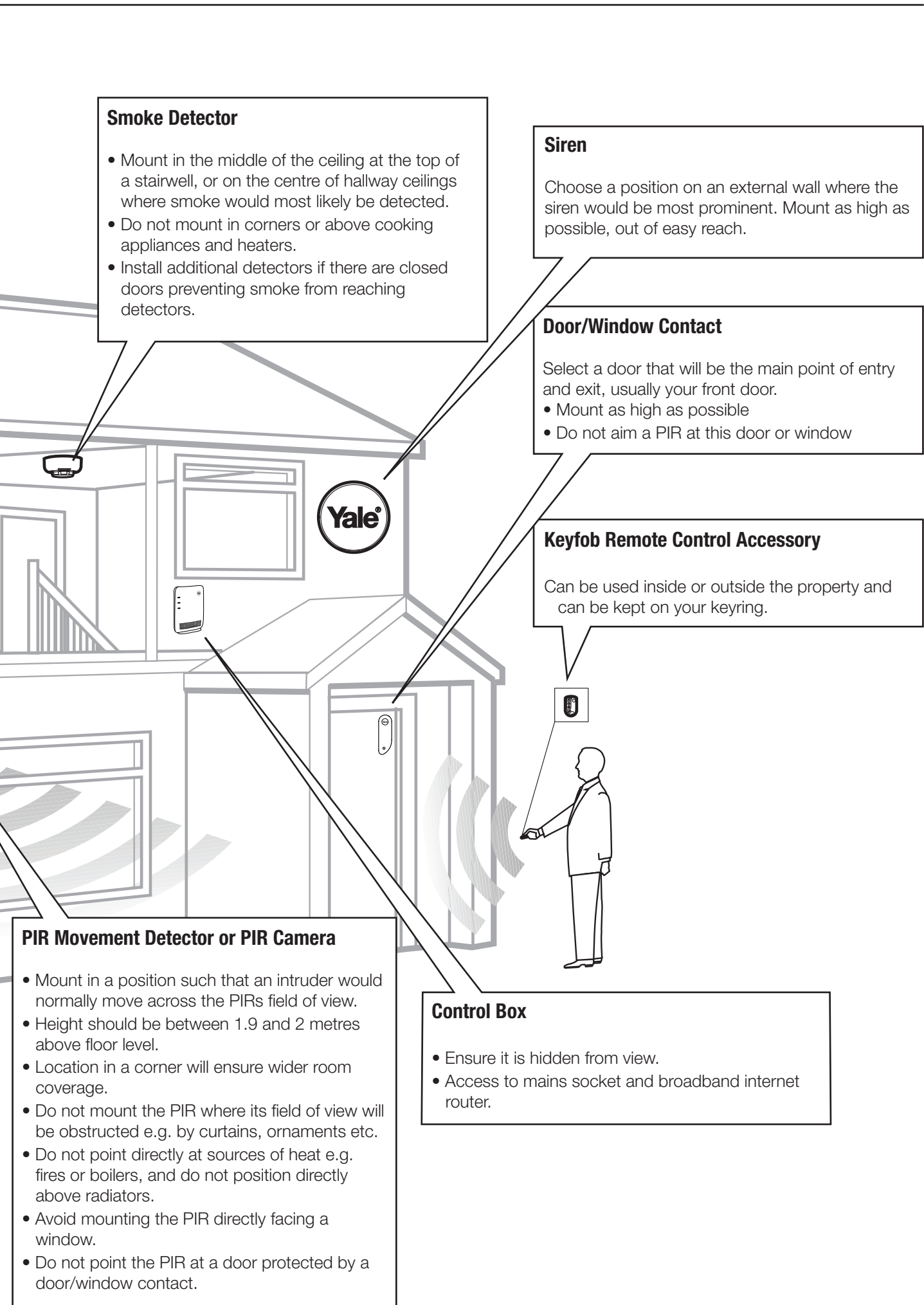

# 2 Unpack all the parts

## Control Box EF-IPBOX

Unpack the kit content on a table. Remove the mounting plate (if fitted) from the control unit by sliding plate downwards. A power adaptor is supplied that plugs into the main wall socket and control unit. Plug in the power adaptor and connect the box to your internet router using the cable provide.

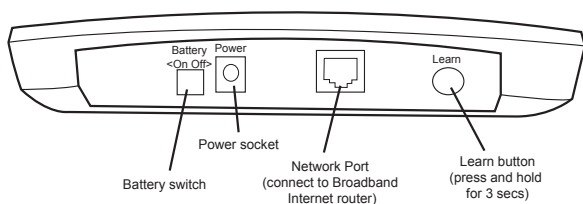

- In addition to the adapter, there is a rechargeable battery inside the control unit that serves as a backup in case of a power failure. A fully charged battery can provide backup power for a period of at least 10 hours. It takes approximately 72 hours to fully charge the battery.
- Remove the rubber battery switch cover and locate the battery switch. Switch ON the internal battery and replace the rubber cover.

### Top LED 1 (Panel Status)

- Red** ON: System Arm  
FLASH: Home Arm
- Green** ON: Disarm  
FLASH: Learn mode  
OFF: Walk test mode

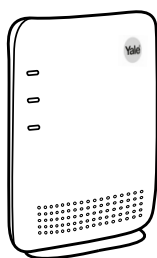

### Middle LED 2 (Alarm & Fault Status)

- Red** ON: Alarm been triggered  
FLASH: Ongoing alarm event
- Yellow** ON: Device fault (Tamper/Low battery)  
FLASH: Mains power failed  
OFF: Normal

### Bottom LED 3 (Operation Status)

- Yellow** ON: Slow network, may have problem.  
FLASH: Network initialise
- Green** ON: Normal  
FLASH: Connecting to Yale server  
OFF: System in learn mode or Mains failed

## Siren EF-BX

### WARNING

The siren is very loud, be prepared! Take care not to activate the siren tamper switch unnecessarily.

- 1 Remove the cover by unscrewing the single screw located on the lid. Power switch to ON position.

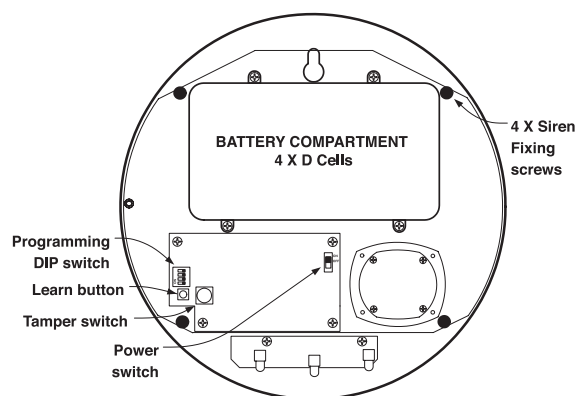

## PIR Movement Detectors EF-PIR

- 1 Pull out the plastic pull tab on the back of the PIR. This will activate the batteries.

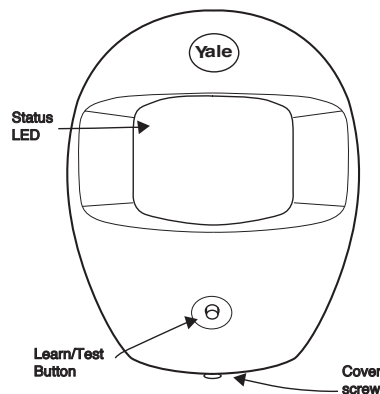

## Door/Window Contacts EF-DC

- 1 Pull out the battery saver tab on the side to activate the battery.

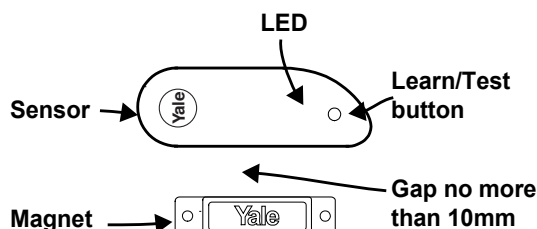

## Keypad Remote Control EF-KP

- 1 Pull out the plastic battery saver tab at the back of the remote keypad. This will activate the batteries.

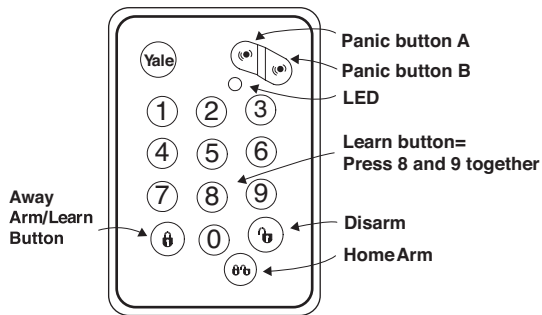

## SmartPhone Alarm Accessories:

- PIR image camera EF-PC
- PIR video camera EF-PVC
- Room sensor (Temperature/Humidity) EF-RS
- Power switch EF-PS

- 1 Insert AA/AAA batteries as supplied. Power switch do not require any battery.

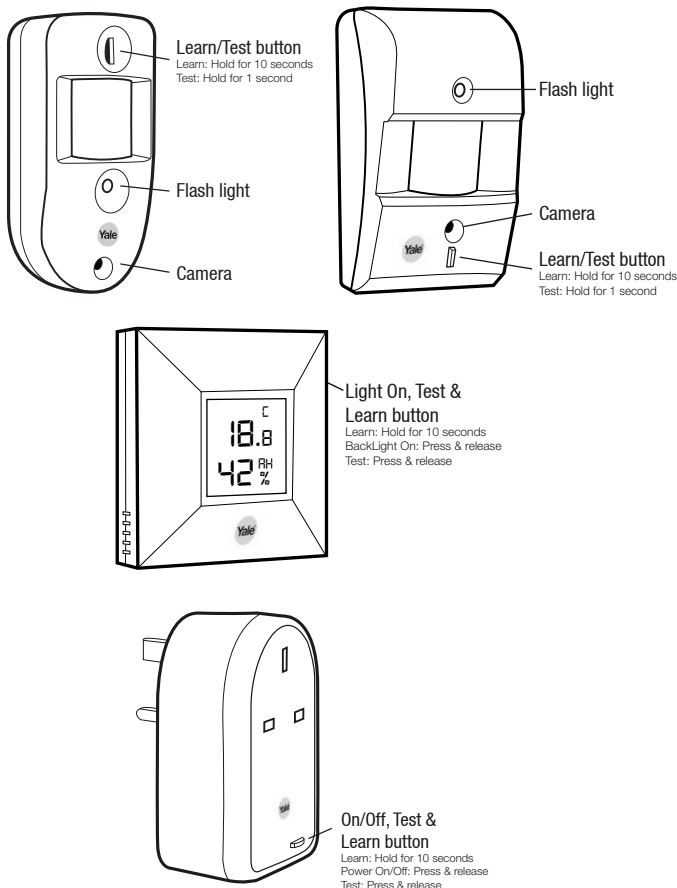

## Keyfob Remote Control EF-KF

- 1 Open the battery compartment using a coin by turning cover in the direction of the big arrow so the small arrow is next to round dot.
- 2 Insert CR2032 battery and replace cover.

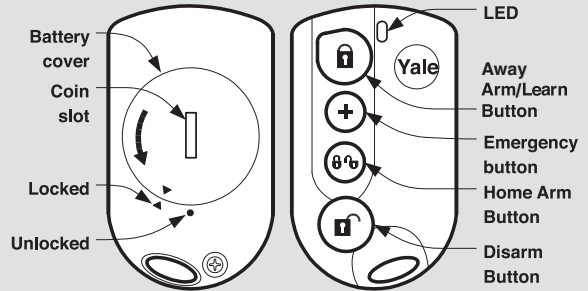

## Smoke Detector EF-SD

- 1 Remove the cover and insert three AA batteries
- 2 The smoke detector will now enter into self-calibration mode for 15-20 minutes. It will resume normal operation after this period.

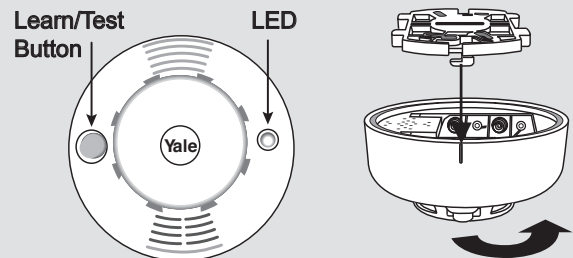

## Help Button EF-PB

Remove the cover by loosening the fixing screw and insert the CR2032 battery (supplied) as shown (1). Please ensure you observe battery polarity.

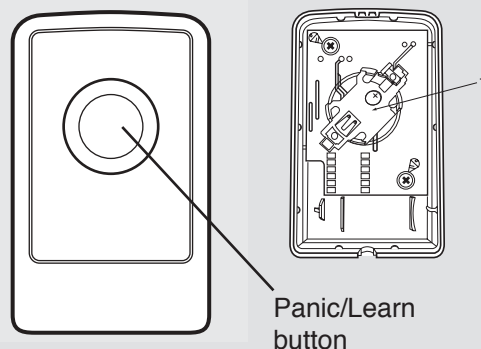

# 3 Initial set-up

Please ensure all devices are powered and operational at this point.

## Download Yale app (Smart Phone)



Search term in app store: Yale Home System  
Compatibility: iOS 4.3+, Android 2.2+ (with minimum resolution 320x480)  
Internet connection: Required on Smart Phone

## First time registration

Starts the app on your phone. \*Please note that the graphic may differ from shown.

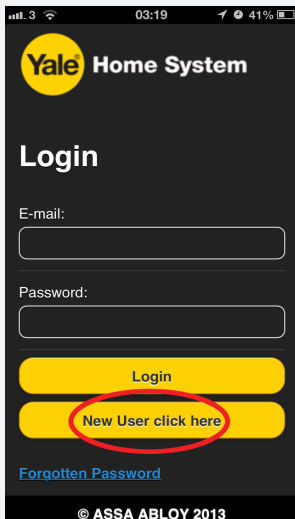

### Select

New user click here

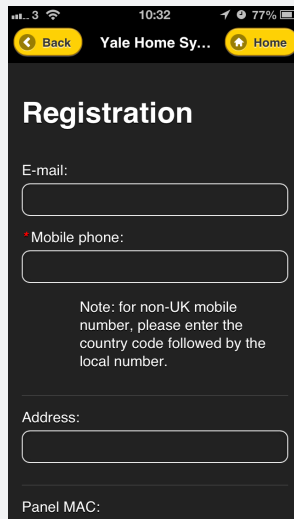

### Enter your details

Panel MAC can be found on the Control box's sticker.

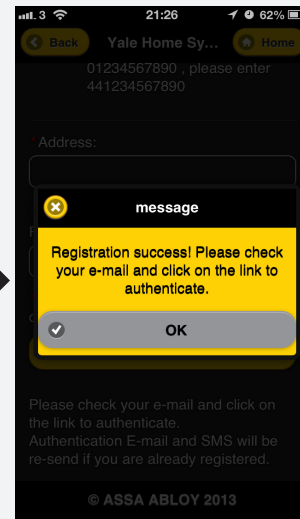

### Close app

Wait for:

- 1) Authentication email (also check spam folder)
- 2) SMS with Auth code

Once you have received BOTH the authentication email and SMS, click on the email link:

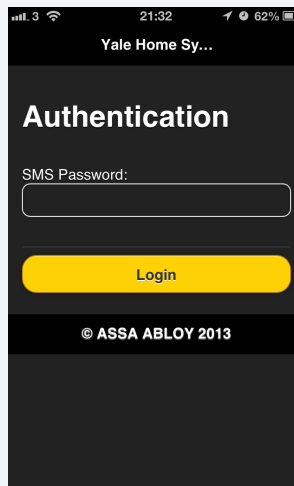

### Enter SMS Auth code.

If you encounter errors, it is due to the control box not communicating with our server. Please check that you have connected your panel to the internet.

You will be asked to set-up a password when registration is successful. Please use your email and this new password to login via the front page.

## Adding accessories (if you purchased extra accessories)

All accessories in the kit are linked to the control box. If you purchased extra accessories (or for some reason the accessories are deleted), please do the following:

1

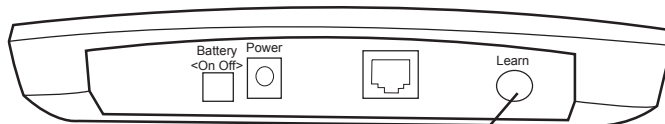

Press and hold the learn button for at least 3 seconds.  
Led 1 will now flash and beep to indicate that you have entered learn mode

2

One by one, press the learn button on the accessories. The control box will beep every time a new device is registered

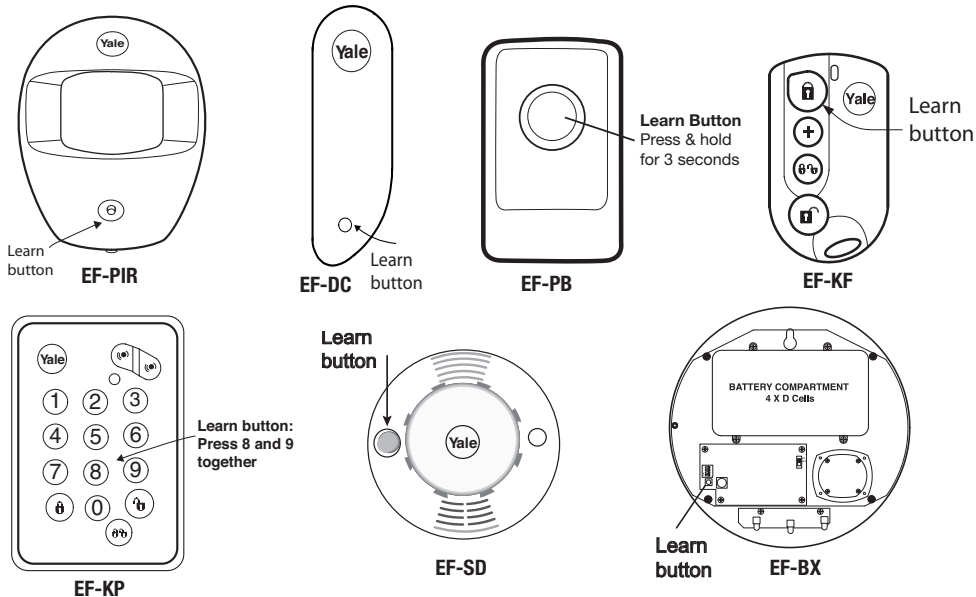

For the following accessories, please hold the learn button for 10 seconds before releasing to learn.

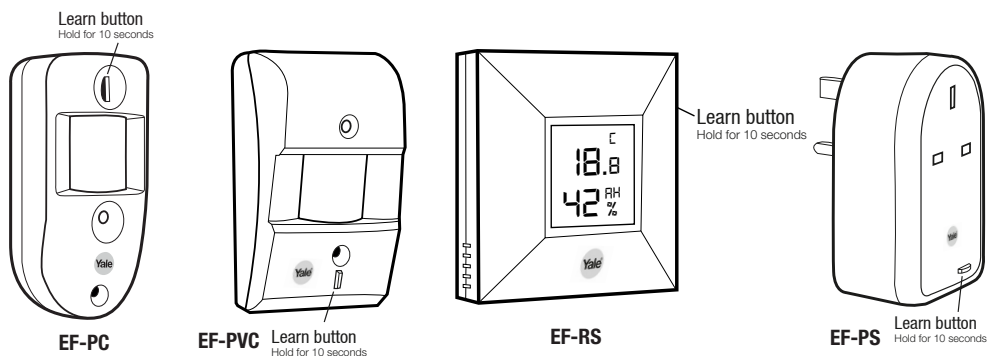

3

### Exit Learn Mode:

Press and hold the control box learn button for at least 3 seconds. The LED should now stop flashing. Proceed to installation.



# 4 Mounting Devices

Tamper switch is disabled when system is disarmed.

## Control Box Mounting

The box can be free standing, either vertically or horizontally on a flat surface.

It is also suitable for wall mounting. Using the two holes on the mounting back plate, mark the position of the holes. Drill two holes and fix with the screws and plugs provided. Hook the control box onto the plate.

## Check accessories range

Find a location where the device is to be mounted, see section "Location Planning" for suggestions.

Before proceeding to mount the devices physically, check that the control box will receive the system radio transmissions by doing a simple radio range test.

Login to your Yale Home system app. Select "Devices", then select "Walk Test".

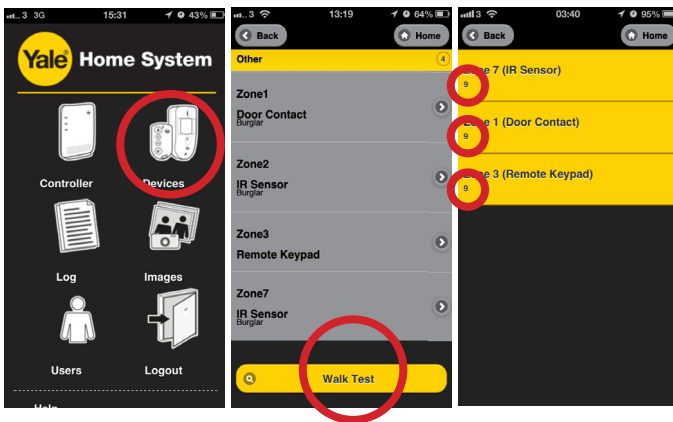

Hold the devices in the desired location and press the Test/Learn button (see below) on the accessories.

- KEYPAD: press button 8 + 9 together for 1 second.
- ALL OTHER DEVICES: Hold the device in the desired location and press the test button for 1 second, the control box should respond with a chime.

If the sensor signal reached the control box, it will show up on the last screen (see above).

The radio signal strength is shown by a number under the device name. This number ranges from 1 to 9 (strongest). Where possible please ensure devices show 3 or above for optimal performance.

When you are happy that all your devices can communicate with the box, please proceed to mounting the accessories

## Mounting the siren

Ensure the tamper switch is fully depressed when the siren is mounted. If there is a gap, pack with a suitable spacing material.

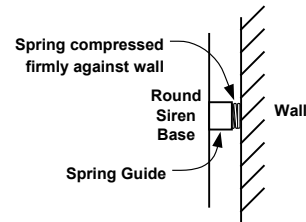

1 Using the large screws and wall plugs provided, screw the siren onto the wall through the 4 mounting holes on the siren base.

2 Fix the siren cover with the securing screw.

## Mounting the PIR & PIR image/video camera

1 Open the PIR by loosening the bottom screw. Knock out the relevant holes on the base where the plastic is thinner. The center 2 knockout holes are for flat wall mounting while the 4 side holes are for corner mounting.

2 Drill holes into the wall using the knockout holes on the base as a template.

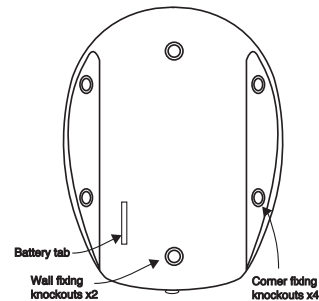

3 Fit wall plugs and secure the PIR base with the screws provided.

4 Fit the PIR back together and tighten bottom screw, the PIR installation is complete.



## Mounting the Keypad:

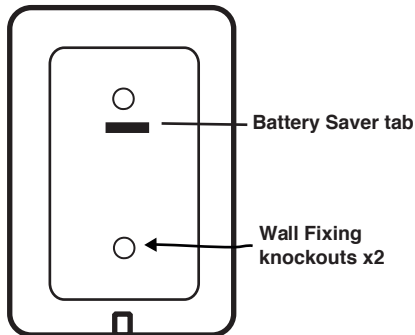

- 1 Knock out the fixing holes. Drill holes into the wall using the fixing holes as a template.
- 2 Fit wall plugs into the wall and fix back cover with the screws provided. Fix front of the keypad onto the back plate.

## Mounting the Door Contact

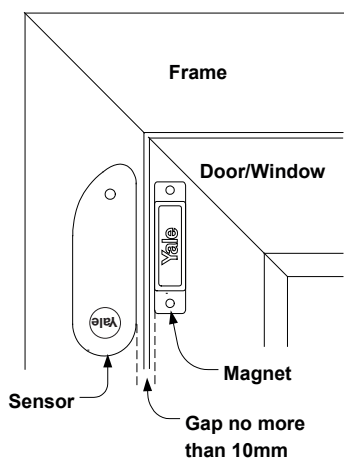

- 1 Find a location on the door/window where you would like the device to be mounted. The sensor should be on the frame while the magnet should be on the door/window. Once mounted make sure the tamper switch spring is fully depressed.

**i** The gap between the magnet and sensor should be no more than 10mm when closed (maybe shorter depending upon the actual environment).

Simple test to see whether the magnet is in range of the sensor: hold the magnet and sensor in place and then pull them apart. If the sensor LED lights up it implies the two items are within range.

### -Mounting using adhesive pads

Clean the mounting surface with a suitable

degreaser agent. Please note that some surface or environment (i.e. exposure to Sunlight) maybe unsuitable for this mounting method. Please use screw mounting in these cases.

### -Mounting using screws and wall plugs

Loosen the bottom screw and open the door/window contact. Knock out the holes on the base as shown. Drill holes into the mounting surface using the holes in the knockouts on the base as template. Fit wall plugs (if required) and secure with the screws provided.

## Mounting the Help button

- 1 Break through the knockouts (where the plastic is thinner).
- 2 Using the holes as a template, drill holes in the surface and insert wall plugs if fixing into plaster or brick. Screw the rear case to the wall. Replace the cover and tighten the screw.

## Mounting the Smoke Detector

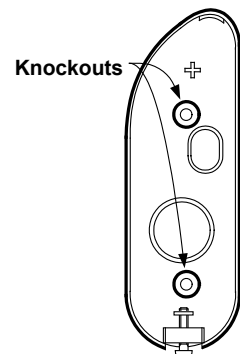

- 1 The base has two mounting slots. Using the slots as a template, drill holes and insert the wall plugs if fixing to plaster. Screw the rear case to the ceiling using the screws provided.

- 2 Replace the main unit onto the bracket.

## Mounting the Room Sensor

- 1 Push tab to the left to open the case. The base has two mounting slots. Using the slots as a template, drill holes and insert the wall plugs if fixing to plaster. Fix the base to the wall with screws.

- 2 Replace the main unit onto the base.

# About your alarm system (default settings)

## All accessories are pre-set to “entry” attributes.

When the system is first armed, users will have 30 seconds to exit the building. The System will ignore any sensors triggering in this duration.

If the system is already armed, triggering any sensors will cause an entry countdown to begin.



To change the exit and entry timer, please see “Controller” -> “Panel Setting”

Home arming is disabled by default. If you need Home arming function, see page 11.

To change the attributes of individual sensors (i.e. Burglar attribute where the individual sensor will instantly alarm when triggered), please go to “Devices”, then click on sensor’s arrow (on the right).

## When the alarm is triggered, the system will send an email, push notification (iOS only) and SMS to alert the owner.

The network traffic condition will determine how quickly user is alerted. There maybe noticeable delay should the third party email/SMS gateway becomes congested.



Each system has 20 free SMS credits, after which Yale reserves the right to charge for any additional SMS sent.

## It is possible to arm the system with “open” door contact (i.e. windows open).



You will be prompted on the app when trying to arm with your door/window open.

## Jamming and interference detection disabled as default.



If Jamming and interference is of concern, please enable via “Controller” -> “Panel Setting”

## Supervision is disabled as default (recommended).



Enable or disable supervision detection on the control box. PIR, Door Contact, Smoke Detector and Siren can be monitored for outage using this feature. Except for Smoke Detector (which is always on), the other three accessories need to have supervision enabled on board to facilitate this feature.

Supervision can be enabled via “Controller” -> “Panel Setting”.

## Comfort LED is disabled as default (recommended).



Please enable Comfort LED via “Devices” -> Siren properties (arrow on the right).

*NOTE: This function will significantly reduce your Siren’s battery life.*

# 5 Using the System

**i** The PIR/PIR camera have a built-in sleep timer to save battery power. If there is no movement in front of the PIRs for 1 minute, the PIRs will become 'ready to signal' and movement will now be reported. The PIRs will sleep for 1 minute after reporting.

Any movement detected in sleep time will not be reported and will extend the sleep period by a further 1 minute.

## Setting up home arm mode

The Home Arm mode allows the home to be partially armed so that no one can get inside without first disarming the system. However, the person inside the house can move freely around without triggering the alarm. Home mode is usually used to protect the ground floor when you are upstairs in bed.

To enable home arm, you need to choose **the sensors to be ignored** during this mode. It would typically be the bedroom PIR etc if you want to arm your system during the night. These sensors should be set to Home Omit in order to be ignored during Home Arm mode. If you wish to trigger alarm count down with a sensor during Home Arm mode, please select the attribute: Home Access.

## Changing your keypad pincode

The default keypad pincode is 1234. You can set up to 6 sets of pincode by:

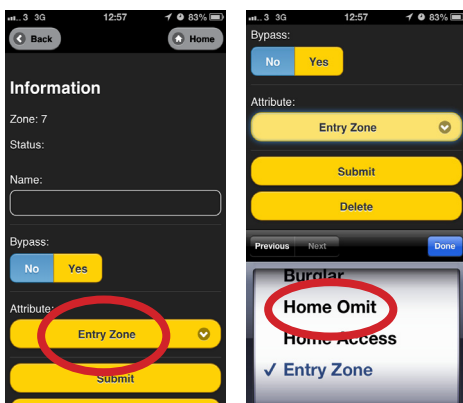
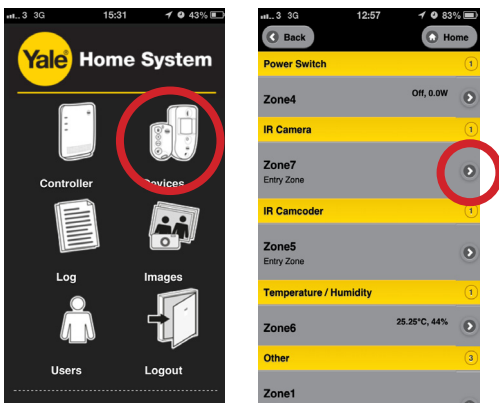
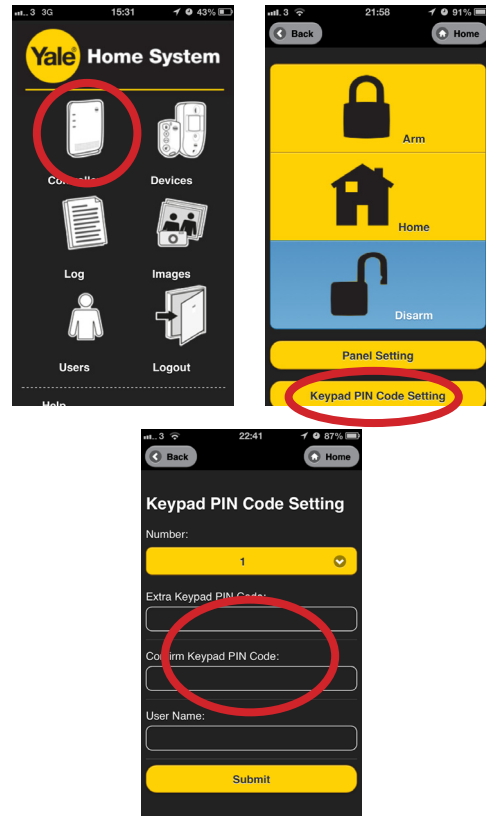

## Arming and Disarming your alarm

Using the Yale Home system app

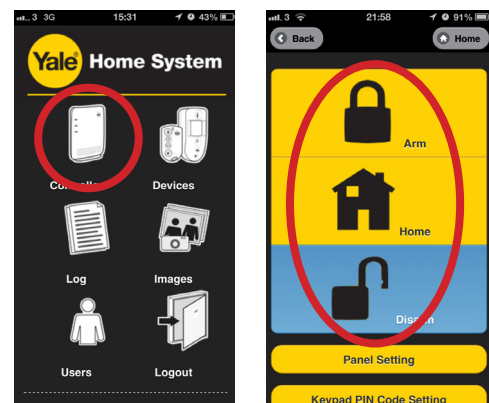

## Using the keyfob (EF-KF) or keypad (EF-KP)

### Away Arm & Home Arm

Press the Away Arm/Home Arm key on the keyfob or keypad.

### Disarm

Press the disarm key on the keyfob or press the disarm key followed by a pincode on the keypad.

## Manually requesting PIR images

During an alarm, the PIR image/video camera will send images/video to your phone. You can also manually request these images/video. Still images take an average of 15 seconds before showing on your phone, and video takes approximately 1 minute. Click on "image" to view images/videos.

*Note: Up to 100 images/videos can be kept in the Yale Server (the oldest images/videos are automatically deleted to make space). Users are advised to delete unwanted images/videos.*

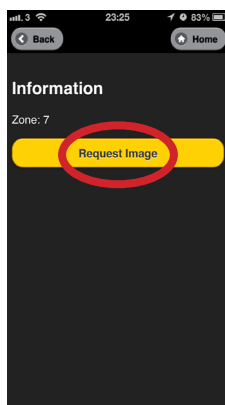
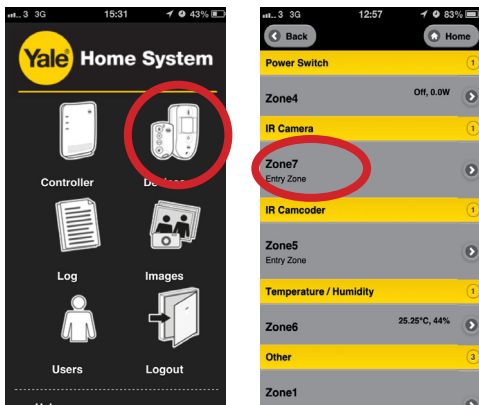

## Adding alert email/SMS

You can add/delete email and SMS phone numbers for alert during alarm condition. Only Burglar events will be reported via SMS, while you can choose to have ALL events (or Burglar only) reported via email.

*Hint: our report email will use the email address of: report@yalehomesystem.co.uk Save this email address as your VIP (Apple iOS) or Priority (Android) email and assign a special ringtone to it.*

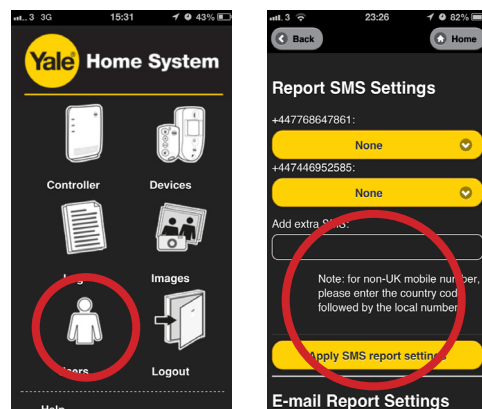

## Controlling Yale Digital door lock

This is a reserved function for use with our Digital door lock. We will shortly be launching a module compatible with our Yale Digital door lock range.

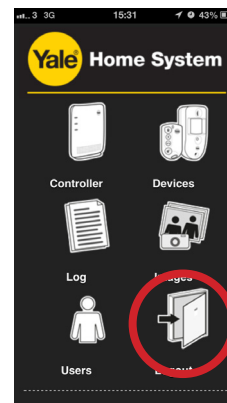

# Adding and using Accessories

To provide additional protection you can add extra door/window contacts, PIRs, keyfob remote controls, keypad remote controls, help buttons and smoke detectors. These are available separately from your local stockist.

## Adding accessories to your system

See page 7

## Using your keyfob

- The keyfob can be used to Away Arm, Home Arm, and Disarm the system using the buttons as shown.
- An emergency alarm can be activated by pressing the emergency button for 3 seconds until LED stops flashing.
- An emergency alarm can only be stopped by using the control unit keypad or a remote keypad.

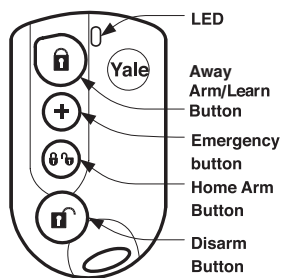

## Keypad

### Keypad initialisation

If you purchase a keypad as an accessory, you will need to initialise it prior to use with the control panel.

- 1 Press 'Panic button A' followed by factory default keypad code '0000' (this is different to your control panel pincode).
- 2 The LED will now flash slowly indicating it is in test (programming) mode.
- 3 Press 'Panic button A' followed by the '7' key to set the keypad into control panel system mode (also known as slave mode).
- 4 Quit test mode by pressing the disarm key twice. The keypad code and mode setting has been completed. The Keypad will now use the same pincode that is set for the control panel unit.

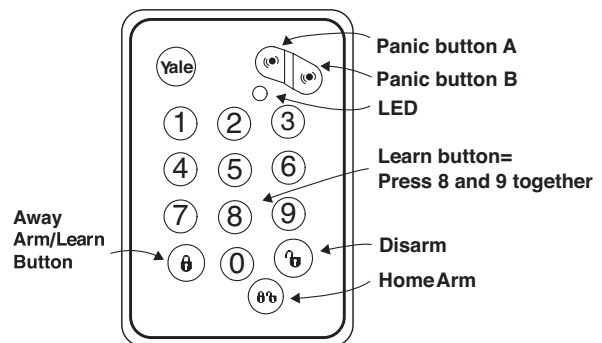

### Forgotten keypad code (different to disarming pincode)

If the keypad code is accidentally forgotten, the keypad can be reset to factory default (0000) using the following steps:

- 1 Unscrew the two keypad case screws and remove keypad back cover (please disable tamper first). Locate and remove the battery.
- 2 Press the number '4' key at the same time as reinserting the battery.
- 3 Screw the keypad case together and re-learn the keypad into the system using the steps described above in this section.

---

## Using your keypad

- The keypad can be used to Away Arm and Home Arm the system using the buttons as shown.
- The system is disarmed by pressing the disarm button followed by any user code.
- An emergency alarm can be activated by pressing the panic A and B buttons simultaneously. Deactivate panic event by pressing the disarm button followed by any user code.
- If there is a system fault, you will need to press the arm/home arm button for a second time to “force arm” the system.

## Using your smoke detector

### Smoke Detection

When smoke is detected the device will activate for a minimum of 10 seconds with a two tone alarm and flashing LED for a local fire alarm. The detector will send a radio signal to the control unit for activating a system fire alarm.

- Pressing the test button when in an alarm condition will silence the alarm for 10 minutes. It will automatically resume smoke detection again after this period.
- If the smoke density is still over the alarm threshold, then the smoke detector will remain in an alarm condition and it will repeat the local fire alarm with a radio fire alarm signal to the control unit.

### Testing

- Smoke detector testing should be done on a regular monthly basis. Pressing the test button will make the LED flash, the audible sounder chime and will send a radio test signal to the control unit when the button is released. If nothing happens after pressing the test button, it indicates the batteries will need changing.

### Recalibration

- The smoke detector might need recalibrating after time to ensure it is working at its optimum. This is done by pressing and holding the test button until the LED flashes and beeps after 10 seconds. The detector will then start its self calibration routine.

## Using your Help Button

### Activate an Alarm

- Press and hold the red button for at least 3 seconds. The LED will light momentarily and the alarm will be activated.

### Silence an Alarm

- Press and hold down the red button for 10 seconds. The LED will light momentarily for a second time and the alarm will be silenced.
- Please note that silencing the alarm with the help button does not reset the system. If the alarm is armed prior to activation, the system will re-arm after being silenced with the help button.
- The system will require a reset at the control unit after being silenced with the help button.

# Changing the Batteries

Always use correct type of batteries as replacements because any other battery can cause problems with the operation of the system. Typical life of batteries is two years or more. Ensure the correct steps are taken when changing batteries in tamper protected devices.

## Low Battery Indication

The app will display the low battery message under the actual device.

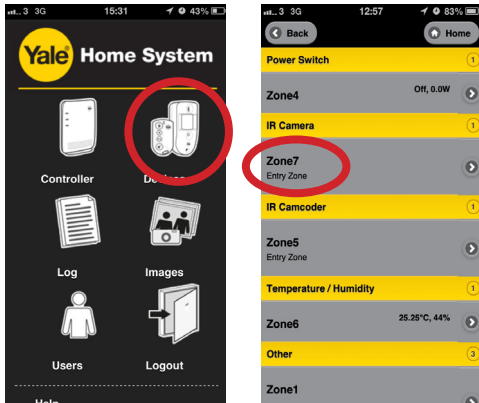

When a device first shows the low battery signal it has enough battery capacity to operate for a further month before complete exhaustion.

## Siren Battery Change

When the batteries start getting low the siren will produce a series of pips and flashes during arming and disarming.

- 1 Select "Devices", click siren's properties (arrow on the right), and set siren tamper to the OFF position.
- 2 Remove the siren lid and switch the siren power switch to OFF.
- 3 Unscrew the four screws on the battery compartment lid and remove the cover.
- 4 Remove the four batteries, wait for 30 seconds, and replace them with four fresh alkaline "D" cells.
- 5 Switch on siren power and check that the siren beeps and flashes.

**Warning:** After the batteries have been inserted, the tamper will become active after three hours. Please replace the cover back onto the siren quickly.

- Siren case tamper conditions are also signalled by a series of beeps when the system is armed but not when the system is disarmed (low battery warning produces a series of pips when armed and disarmed), take care not to confuse the two different conditions.

## PIR & PIR Camera Battery Change

When the battery is low the LED will flash when any movement is detected. The batteries are changed as follows:

- 1 Ensure the system is disarmed.
  - 2 Loosen the case screw and remove PIR sensor from base to reveal the batteries.
  - 3 Insert new batteries (Note: PIR camera requires 1.5V AA Lithium batteries) observing correct polarity. The PIR LED will flash for 30 seconds while initialising.
  - 4 Refit sensor on base and tighten bottom case screw. Switch tamper protection back on.
- PIR case tamper conditions are also indicated by a flashing LED, check the tamper before changing the batteries.

## Door/Window Sensor Battery Change

When the battery is low the LED will light up when the door/window is opened. The battery is changed as follows:

- 1 Ensure the system is disarmed.
  - 2 Loosen the case screw and remove door/window sensor from base to reveal battery.
  - 3 Using a screwdriver gently lever out the old battery.
  - 4 Insert new CR2032 coin cell with the + side uppermost.
  - 5 Press battery into holder firmly with finger and thumb until a click is heard.
  - 6 Refit sensor on base and tighten bottom case screw. Switch tamper protection back on.
- Door/window sensor case tamper conditions are also indicated by a lit LED, check the tamper before changing the battery.



---

### **Keyfob Battery Change**

When the battery is low the LED will glow dimly when any key is pressed. The battery is changed as follows:

- 1** Using a coin turn the battery cover anticlockwise to the unlocked position and remove cover and battery.
- 2** Insert new CR2032 coin cell with the + side uppermost.
- 3** Replace battery cover.

Press any key and check that the LED lights. If the LED lights the new battery installation is successful.

### **Keypad Battery Change**

When the battery is low the LED will flash when any key is pressed. The battery is changed as follows:

- 1** Ensure the system is disarmed.
- 2** Unscrew the two keypad case screws and remove keypad back to reveal battery.
- 3** Using a screwdriver gently lever out the old battery.
- 4** Insert new CR2032 coin cell with the + side uppermost.
- 5** Press battery into holder firmly with finger and thumb until a click is heard.
- 6** Press a number key and check that the LED lights. If the LED lights the new battery installation is successful, screw keypad back on and the battery change is complete.

### **Help Button Battery Change**

When the battery is low the LED will glow dimly when the button is pressed. The battery is changed as follows:

- 1** Loosen the bottom case screw and take button cover off base.
- 2** Insert new 12V 23A/MN21 alkaline miniature 'lighter battery', taking care to observe polarity (see Section 2).
- 3** Replace button cover.

Press the button and check that the LED lights. If the LED lights the new battery installation is successful.

### **Smoke Detector Battery Change**

When the battery is low the LED will flash accompanied with a Low-volume beep once every 30 seconds.

- 1** Rotate smoke detector anti-clockwise to detach from base bayonet fixing.
- 2** Insert new AA alkaline batteries, taking care to observe polarity and wait 15-20 minutes for the smoke detector to recalibrate itself, indicated by a rapidly flashing LED..
- 3** Replace smoke detector on base and rotate clockwise to lock.
- 4** Press the test button and check that the LED lights and the sounder chimes.

# Troubleshooting

---

For online assistance, please visit: [www.Yale.co.uk](http://www.Yale.co.uk)

## Siren

### Siren does not respond to arming or disarming

- Siren batteries are completely exhausted. Check siren batteries by removing siren cover, if there is no tamper alarm when removed, replace batteries with new alkaline equivalents.
- Siren not learnt-in. If siren produces a tamper alarm when the cover is removed and siren is OK, learn-in the siren.
- Siren out of range.

### Siren produces a 3 second alarm when disarmed

- There has been a previous alarm and there might be an intruder still in the premises.

### Siren produces a series of pips when armed or disarmed

- The siren has low batteries. Check that the siren produces a series of pips when arming and disarming, indicating low batteries. Change batteries with new alkaline replacements.
- The siren tamper switch has been disturbed. Check that the siren produces a series of pips only when arming, indicating a tamper fault. Check that the siren cover is firmly secured and the tamper switch plunger is in contact with the wall. If not use suitable packing material to fill gap.

### Siren produces an interrupted tone when sounding an alarm

- The siren has low batteries. Change batteries with new alkaline replacements.
- 

## PIR

### PIR does not respond to movement

- Previous movement has triggered the PIR sleep timer and is preventing subsequent movement detection. Arm system and vacate protected room for at least 1.5 minutes before testing.

### PIR is slow to respond

- This is normal, the PIR has sophisticated false alarm filtering that will filter out random fluctuations and responds to genuine movement across field of view, it is less sensitive walking directly towards it.

### PIR gives false alarms

- Check pets have no access to protected area.
- Check that PIR is not pointed at sources of heat or moving objects, e.g. fluttering curtains.

- Check that PIR is not mounted above convector heaters or pointing directly at windows.

### PIR LED flashes

- Batteries are low or the tamper switch is disturbed. Check that the tamper switch spring is making contact with base. If the tamper switch is OK, change batteries with new alkaline replacements.

### PIR does not respond to movement

- Batteries are completely exhausted. Change batteries with new alkaline replacements, LED will flash for 30 seconds while components initialise.
- 

## Door Contact

### Door contact LED lights up

- Batteries are low or the tamper switch disturbed. Check that the tamper switch spring is making contact with the mounting surface. If the tamper switch is OK, change batteries with new CR2032 coin cell replacements.

### Door contact does not respond to door opening when jumper is in test position

- Batteries are completely exhausted. Change batteries with new CR2032 coin cell replacements.
  - The magnet is too far away from the door contact. Check that the gap between door contact and magnet is not greater than 8mm.
- 

## Control box's LED 2 (Warning LED)

**Red** ON: Alarm been triggered. Arm and then disarm the system once more will clear this LED.

FLASH: Ongoing alarm event

**Yellow** ON: Device fault (Tamper/Low battery)

FLASH: Mains power failed

OFF: Normal

# Specifications

---

## All devices

### Environmental conditions

-10°C to 40°C, relative humidity 70% non-condensing for all units except the external siren. Siren: -20°C to 50°C, relative humidity 95% non-condensing

### Radio operational range

30m in a typical domestic installation, range can vary depending on building construction, device positions and RF environment

**Housings** ABS/polycarbonate

## Control box

**Siren Output** 100dBA sound pressure @ 1m minimum

**Zones** 20 radio devices

**Radio system** 868MHz FM, 2.4GHz

**Power supply** Plug top adaptor type, input 230VAC 50Hz, output 12VDC, 2A, tested to EN 60 950

**Rechargeable battery** Ni-MH, 7.2V 600mah, charge time 72hrs, standby time 10hrs

## Siren

**Siren output** 104dBA sound pressure @ 1m minimum

**Radio** 868MHz FM

**Power supply** 6V, 4 x D alkaline cells. 2.5 years typical service life

## Passive infra red (PIR) Detector

**Alarm processing** Microprocessor controlled dual edge sequential pulse count with pulse length discrimination

**Radio** 868MHz FM

**Power supply** 4.5V, 3 x AAA alkaline cells. 2 years typical domestic service life without supervision.

**Movement detection range** 12m, 110°

## PIR image camera

**Alarm processing** Microprocessor controlled dual edge sequential pulse count with pulse length discrimination

**Radio** 2.4GHz

**Power supply** 2 x AA 1.5V Lithium cells (Alkaline/Zinc cells not suitable). 2 years+ typical domestic service life.

**Movement detection range** 12m, 110°

## Door/window contact

**Radio** 868MHz FM

**Power supply** 3V, CR2032 lithium coin cell. 2 years typical domestic service life without supervision.

## Smoke detector

**Radio** 868MHz FM

**Power supply** 4.5V, 3 x AA alkaline cells. 3 years typical domestic service life

**Tested to** EN54

## Keyfob remote control

**Radio** 868MHz FM

**Power supply** 3V, CR2032 lithium coin cell. 3 years typical domestic service life

## Keypad remote control

**Radio** 868MHz FM

**Power supply** 3V, CR2032 lithium coin cell. 3 years typical domestic service life

## Help button

**Radio** 868MHz FM

**Power supply** 3V, CR2032 lithium coin cell. 3 years typical domestic service life

**ASSA ABLOY Ltd.**  
School Street, Willenhall  
West Midlands  
England, WV13 3PW

## EC Declaration of Conformity

We: ASSA ABLOY Ltd.  
School Street  
Willenhall  
West Midlands  
England  
WV13 3PW

declare under our sole responsibility that the following product(s):

Model:	<b>EF-KIT1</b>	<b>EF-KF</b>
	<b>EF-KIT2</b>	<b>EF-KP</b>
	<b>EF-KIT3</b>	<b>EF-BX</b>
	<b>EF-KIT4</b>	<b>EF-SD</b>
	<b>EF-DC</b>	<b>EF-PB</b>
	<b>EF-PIR</b>	<b>EF-PANEL</b>
	<b>EF-PC</b>	<b>EF-IPBOX</b>
	<b>EF-PVC</b>	
	<b>EF-RS</b>	
	<b>EF-PS</b>	
	<b>EF-PETPIR</b>	

is (are) in conformity with the following relevant harmonised standards:

**EN 300 220-1 / V2.3.1 (2010)**  
**EN 300 220-2 / V2.3.1 (2010)**  
**EN 301 489 -1 / V1.8.1 (2008)**  
**EN 301 489-3 / V 1.4.1 (2002)**  
**EN 60 950-1 / 2006 + A11 : 2009 + A1: 2010 + A12:2011**

following the provisions of Council Directive 1999/5/EC on radio equipment and telecommunications terminal equipment and the mutual recognition of their conformity,

Name: John Ward

Position: Director

Signature: 

Date: 15/04/13

On behalf of ASSA ABLOY Ltd.



## 2 Year Guarantee Statement

This product is guaranteed for consumers against faulty workmanship, materials and function for a period of 2 years from the date of purchase providing the full installation and maintenance instructions are followed. Please keep your proof of purchase safe, this must be submitted when making a claim under this guarantee.

Please note that it is a condition of this guarantee that your Yale product:

- Has been correctly installed and maintained in accordance with the Yale installation and maintenance instructions provided to you at the time of purchase.
- Has not been modified or damaged in any way.
- Has not been subjected to unauthorized repairs.

Yale are responsible under this guarantee for repairing the product or replacing the product as we deem necessary. If there is fault with the product, please contact Customer Services on 01902 364647, who will give you the name of an expert and confirm what you need to do to make a claim under this guarantee.

Please do not carry out any repairs without our authority or by using an unauthorised expert. Any repairs or other works carried out without our authorization or by using an unauthorized expert will not be covered under this guarantee.

This guarantee is non transferrable and applies to products purchased in the United Kingdom only. This guarantee does not apply to normal wear and tear. This does not affect your statutory rights. A full copy of this guarantee is available upon request by writing to Yale UK, School Street, Willenhall, West Midlands. WV13 3PW or by visiting our website [www.yale.co.uk](http://www.yale.co.uk).



### WEEE

Note: Waste electrical products and batteries should not be disposed of with household waste. Please recycle where facilities exist. Check with your local authority or retailer for recycling advice.



E8 06\13

**THE YALE BRAND**, with its unparalleled global reach and range of products, reassures more people in more countries than any other consumer locking solution.

**THE ASSA ABLOY GROUP** is the world's leading manufacturer and supplier of locking solutions, dedicated to satisfying end-user needs for security, safety and convenience.