

**TRITON**

**TEMPTATION**  
**touch control**  
**electric shower**



**Installation and  
operating  
instructions**

INSTALLERS PLEASE NOTE THESE INSTRUCTIONS  
ARE TO BE LEFT WITH THE USER



**Please read this book thoroughly and familiarise yourself with all instructions before commencing installation** and keep it for future reference.

The shower installation **MUST** be carried out by a suitably qualified person, **in the sequence of this instruction book.**



## INTRODUCTION - PLEASE READ



### PLEASE READ THIS IMPORTANT SAFETY INFORMATION

Products manufactured by Triton are safe and without risk provided they are installed, used and maintained in good working order in accordance with our instructions and recommendations.

- ⚠ WARNING: DO NOT** operate shower if frozen, or suspected of being frozen. It must thaw out before using.
- ⚠ DO NOT** operate the unit if the showerhead or spray hose becomes damaged.
- ⚠ DO NOT** restrict flow out of shower by placing showerhead in direct contact with your body.
- ⚠ DO NOT** operate the shower if water ceases to flow during use or if water has entered inside the unit because of an incorrectly fitted cover.

This book contains all the necessary fitting and operating instructions for your electric shower.

Care taken during the installation will provide a long, trouble-free life from your shower.

Triton recommend watching the short online \*videos that cover electric shower basics before your installation - \*(videos may not show the exact model purchased).

- **What is an electric shower?**
- **Electrical requirements for electric showers**
- **Plumbing requirements for electric showers**
- **Kilowatt ratings explained**

To view these videos visit: [www.tritonshowers.co.uk/triton-products/product-videos.aspx](http://www.tritonshowers.co.uk/triton-products/product-videos.aspx)

### PLEASE USE THE FOLLOWING CHECK LIST TO AID YOUR INSTALLATION

	Tick off as you complete
<b>SECTION 1</b> Check that the water supply will satisfy requirements .....	<input type="checkbox"/> 1
<b>SECTION 2</b> Check that water & cable entry points of the unit meet requirements .....	<input type="checkbox"/> 2
<b>SECTION 3</b> Check that the electric supply will satisfy requirements .....	<input type="checkbox"/> 3
<b>SECTION 4</b> Siting of the shower .....	<input type="checkbox"/> 4
<b>SECTION 5</b> Plumbing installation .....	<input type="checkbox"/> 5
<b>SECTION 6</b> Electrical installation .....	<input type="checkbox"/> 6
<b>SECTION 7</b> Fit to the wall & connect the shower supplies .....	<input type="checkbox"/> 7
<b>SECTION 8</b> Fitting the cover .....	<input type="checkbox"/> 8
<b>SECTION 9</b> <b>ONLY Commission the shower in the way described</b> .....	<input type="checkbox"/> 9
<b>SECTION 10</b> Familiarise yourself with the user operating instructions .....	<input type="checkbox"/> 10

## 1 GENERAL

- 1.1 Isolate the electrical and water supplies before removing the cover.
- 1.2 Read all of these instructions and retain them for later use.
- 1.3 **DO NOT** take risks with plumbing or electrical equipment.
- 1.4 Isolate electrical and water supplies before proceeding with the installation.
- 1.5 The unit must be mounted onto the finished wall surface (on top of the tiles). **DO NOT** tile up to or seal around **ANY PART** of the unit using silicone sealer after fixing to the wall. Special care must be taken **NOT TO BLOCK OR SEAL ANY PRD VENTS ON THE UNIT.**
- 1.6 Contact Customer Service (*see back page*), if any of the following occur:
  - a) *If it is intended to operate the shower at pressures above the maximum or below the minimum stated.*
  - b) *If the unit shows a distinct change in performance.*
  - c) *If the shower is frozen.*
- 1.7 If it is intended to operate the shower in areas of hard water (above 200 ppm temporary hardness), a scale inhibitor may have to be fitted. For advice on the Scale Inhibitor, contact Customer Service.
- 1.8 The showerhead must be cleaned regularly with descaler to remove scale and debris, otherwise restrictions to the flow on the outlet of the unit will result in higher temperatures and could also cause the (PRD) Pressure Relief Device in the unit to operate.
- 1.9 This product is not suitable for mounting into steam rooms or steam cubicles.

## 2 PLUMBING

- 2.1 The plumbing installation must comply with Water Regulations, Building Regulations or any particular regulations as specified by Local Water Company or Water Undertakers and should be in accordance with BS EN 806.
- 2.2 The supply pipe must be flushed to clear debris before connecting to the shower unit.

- 2.3 **DO NOT** solder pipes or fittings within 300mm of the shower unit, as heat can transfer along the pipework and damage components.
- 2.4 **DO NOT** fit any form of outlet flow control as the outlet acts as a vent for the heater can.
- 2.5 **DO NOT** use excessive force when making connections to the flexible hose or showerhead, finger tight is sufficient.
- 2.6 All plumbing connections must be completed before making the electrical connections.
- 2.7 This appliance **MUST** not be connected to the inlet supply by a hose-set.

## 3 ELECTRICAL

- 3.1 The installation must comply with BS 7671 'Requirements for electrical installations' (IEE wiring regulations), building regulations or any particular regulations as specified by the local Electrical Supply Company.
- 3.2 This appliance **MUST** be earthed.
- 3.3 In accordance with 'The Plugs and Sockets etc. (Safety) Regulations 1994', this appliance is intended to be permanently connected to the fixed wiring of the electrical mains system.
- 3.4 Make sure all electrical connections are tight to prevent overheating.
- 3.5 A 30mA residual current device (RCD) **MUST** be installed in all UK electric and pumped shower circuits. This may be part of the consumer unit or a separate unit.
- 3.6 Switch off immediately at isolating switch if water ceases to flow during use.
- 3.7 Other electrical equipment i.e. extractor fans, pumps must not be connected to the circuits within the unit.
- 3.8 Switch off at isolating switch when not in use. This is a safety procedure recommended with all electrical appliances.

- 3.9 As with all electrical appliances it is recommended to have the shower and installation checked at least every two years by a competent electrician to ensure there is no deterioration due to age and usage.

## WARNING

This appliance can be used by children aged from 8 years and above and persons with reduced physical, sensory or mental capabilities or lack of experience or knowledge if they have been given supervision or instruction concerning use of the appliance in a safe way and understand the hazards involved. Children may not play with the appliance. Cleaning and user maintenance shall not be made by children without supervision.

## GENERAL ADVICE TO USERS

The following points will help you understand how the shower operates:

- a.** The electric heating elements operate at a constant rate at your chosen power setting. It is the rate of the water passing through the heater can which determines the water temperature. (The slower the flow, the hotter the water becomes; the faster the flow, the cooler the water).
- b.** During winter, the mains water supply will be cooler than in the summer. The flow rate will vary between seasons at any one temperature setting. At different times of the year you may have to adjust the position of the temperature control to maintain your desired temperature setting.
- c.** The stabiliser valve minimises variations in shower temperature during mains water pressure changes. If changes in shower temperature are experienced during normal use, it will most likely be caused by the water pressure falling near to or below the minimum level. The drop in pressure may be due to water being drawn off at other points in the house whilst the shower is in use. If pressure drops appreciably below the minimum, the heating elements will automatically cut out.

**NOTE:** *The 'display screen' is a representation of the showering temperature, and not an 'absolute' temperature reading. The display has a temperature tolerance of 2°C.*

**NOTE:** *If ever the water becomes too hot and you cannot obtain cooler water, first check that the sprayplate in the showerhead has not become blocked.*

**DO NOT** place items such as soap or shampoo bottles on top of the unit. Liquid could seep through the joint between the cover and backplate.

## IMPORTANT ADVICE TO USERS

### COMISSIONING ADVICE

**When first installed the unit will be empty. It is essential the unit should contain water before the elements are switched on. It is vital that the commissioning procedure is followed. Failure to carry out this operation will result in damage to the unit and will invalidate the guarantee.**

### ADVISORY - CLEANING

It is recommended that all products are cleaned using warm, soapy water.

**DO NOT** use abrasive or aggressive chemical cleaning products as this may affect the product surface finish and invalidate your guarantee.

## CONTENTS

Page

INTRODUCTION	
IMPORTANT SAFETY INFORMATION ( <i>please read</i> )	
Installation check list ( <i>please follow &amp; complete</i> )	
GENERAL GUIDANCE NOTES	
GENERAL ADVICE TO USERS - CLEANING ADVICE	
SPECIFICATIONS.....	2
DIMENSIONS & CABLE/WATER ENTRY POINTS .....	3
ELECTRICAL REQUIREMENTS .....	4 - 5
<b>INSTALLING THE SHOWER.....</b>	<b>6 - 14</b>
Siting of the shower .....	6 - 7
Plumbing installation.....	8
Electrical installation .....	9
Fit to the wall & connect shower supplies.....	9 - 11
Fitting the cover .....	12
<b>COMMISSIONING PROCEDURE .....</b>	<b>13 - 14</b>
Connecting the PCB cable.....	14
<b>USER OPERATING INSTRUCTIONS.....</b>	<b>15 - 17</b>
Operating functions.....	17
Cleaning the filter - installers & service engineers only .....	18
Fault finding/Troubleshooting.....	19 - 20
Spare parts .....	21
<b>SHOWER CONTROLS - QUICK USER GUIDE .....</b>	<b>Inside rear cover</b>
UK Service Policy/UK Guarantee .....	Rear cover

To check the product suitability for commercial and multiple installations, please contact Triton's specification advisory service before installation.

Telephone: 0844 980 0730

Facsimile: 0844 980 0744

E mail: [technical@tritonshowers.co.uk](mailto:technical@tritonshowers.co.uk)

<b>ELECTRICAL</b>	
Nominal power - rating at 240V	Nominal power - rating at 230V
<b>8.5kW</b> – (40A MCB rating)	7.8kW – (40A MCB rating)
<b>9.5kW</b> – (40A MCB rating)	8.7kW – (40A MCB rating)
<b>PLUMBING</b> (see page 6 & 7 for water regulations)	
Supply Source	Mains pressure cold water only
Minimum running pressure and flow to the inlet of the shower for full performance	100kPa (1 bar) at 8 litres per minute
Maximum static pressure	1000 kPa (10 bar)
Maximum inlet temperature	28°C
Minimum inlet temperature	2°C
Inlet connection	15mm diameter
Outlet connection	½" BSP male thread
<b>MATERIALS</b>	
ABS	Backplate, cover, controls, showerhead
Acetal	Sprayplate
Minerally insulated corrosion resistant metal sheathing	Elements
<b>STANDARDS and APPROVALS</b>	
Splashproof rating	IPX4
Safety	Complies with the requirements of current British and European safety standards for household and similar electrical appliances
BEAB	Complies with requirements of the British Electrotechnical Approvals Board (BEAB)
CE	Meets with Compliance with European Community Directives (CE)

**Fig.1**

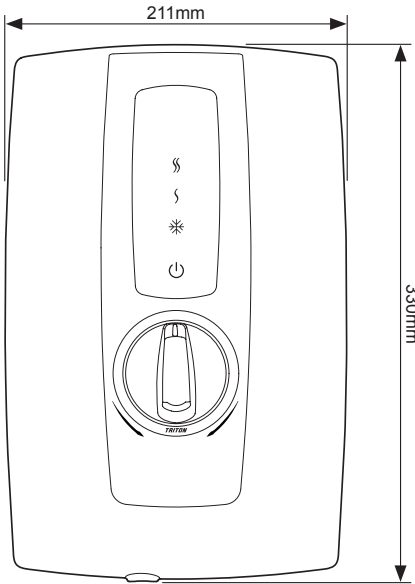

**DIMENSIONS**

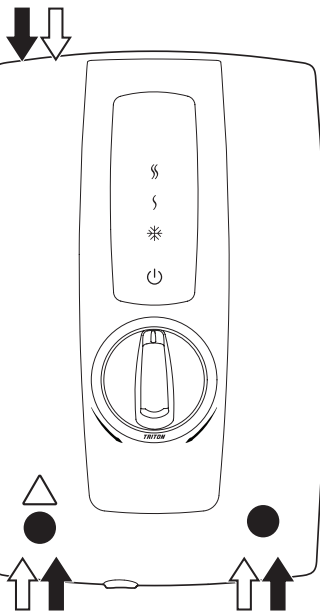
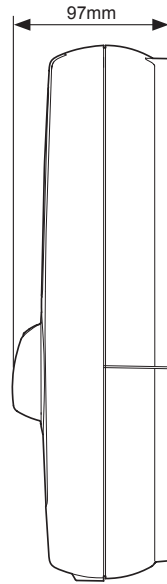

**ENTRY POINTS**

**WATER** ● = Back ➔ = Others

**Left:** Top, Bottom, Back.

**Right:** Bottom, Back.

**CABLE** △ = Back ➔ = Others

**Left:** Top, Bottom, Back.

**Right:** Bottom.

**PLEASE NOTE:** Deviation from the approved entry points will invalidate product specifications and warranty.

**Fig.2**

## ELECTRICAL REQUIREMENTS

**WARNING!****THIS APPLIANCE MUST BE EARTHED**

The installation, supply cable and circuit protection must conform with BS 7671 (IEE wiring regulations) and be sufficient for the amperage required.

**The following notes are for guidance only:**

- 1** The shower must only be connected to a 230-240V ac supply. If you are installing a shower with a kilowatt rating above 9kW, it is advisable to contact the local electricity supply company.
- 1.1** The electrical rating of the shower is shown on the rating label (**Fig.3**) within the unit.
- 2** Before making any sort of electrical connection within the installation make sure that no terminal is live. If in any doubt, switch off the whole installation at the mains supply and remove the correct fuse.
- 3** The shower must be connected to its own independent electrical circuit. **IT MUST NOT** be connected to a ring main, spur, socket outlet, lighting circuit or cooker circuit.
- 3.1** The electrical supply must be adequate for the loading of the unit and existing circuits.
- 4** Check your consumer unit (main fuse box) has a main switch rating of 80A or above and that it has a spare fuse way which will take the fuse or Miniature Circuit Breaker (MCB) necessary for the shower (**Fig.4**).
- 4.1** If your consumer unit has a rating below 80A or if there is no spare fuse way, then the installation will not be straightforward and may require a new consumer unit serving the house or just the shower.
- 4.2** You will need to contact the local electricity company. They will check the supply and carry out what is necessary.
- 5** For close circuit protection **DO NOT** use a rewirable fuse. Instead use a suitably rated Miniature Circuit Breaker (MCB) or cartridge fuse (**see Table A**).
- 5.1** A 30mA residual current device (RCD) **MUST** be installed in all UK electric and pumped shower circuits. This may be part of the consumer unit or a separate unit.

**Fig.3**

<b>TRITON</b>		Triton Showers, Triton Road, Nuneaton, Warwickshire, CV11 4NR	
MODEL	XXXX		
230-240V X.X - X.XKW	~	BEAB Approved	IPX4
MAX. SUPPLY HEAD	10 METRES		
MIN. SUPPLY HEAD	0.08 METRES		
MAX. HEAD	32 METRES		
RATED PRESSURE	0 PA		XX/XX
SERIAL NO. 000000			No. XXXXXXXXXX

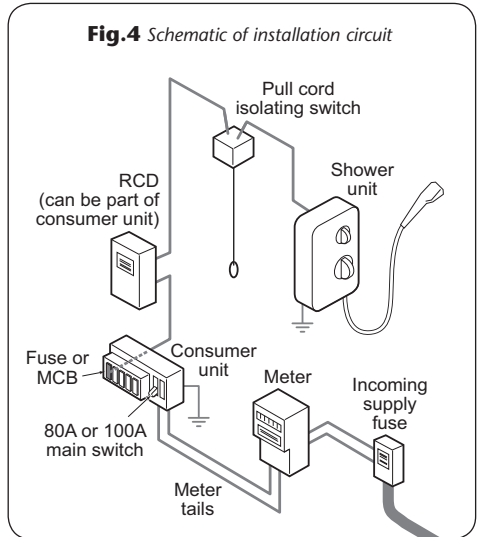
**Fig.4** Schematic of installation circuit**Table A**

CIRCUIT PROTECTION		
unit rating	MCB	cartridge fuse
7.0kW	30/32A	30A
7.5kW	32A	35A
8.0kW	40A	35A
8.5kW	40A	45A
9.0kW	40A	45A
9.5kW	40/45A	45A
10.5kW	45A	45A



- 6 A 45 amp double pole isolating switch with a minimum contact gap of 3 mm in both poles must be incorporated in the circuit.
- 6.1 It must have a mechanical indicator showing when the switch is in the OFF position, and the wiring must be connected to the switch without the use of a plug or socket outlet.
- 6.2 The switch must be accessible and clearly identifiable, but out of reach of a person using a fixed bath or shower, except for the cord of a cord operated switch, and should be placed so that it is not possible to touch the switch body while standing in a bath or shower cubicle. It should be readily accessible to switch off after using the shower.
- 7 Where shower cubicles are located in any rooms other than bathrooms, all socket outlets in those rooms must be protected by a 30mA RCD.
- 8 The current carrying capacity of the cable must be at least that of the shower circuit protection (**see Table B**).
- 8.1 To obtain full advantage of the power provided by the shower, use the shortest cable route possible from the consumer unit to the shower.
- 8.2 It is also necessary to satisfy the disconnection time and thermal constraints which means that for any given combination of current demand, voltage drop and cable size, there is a maximum permissible circuit length.
- 9 The shower circuit should be separated from other circuits by at least twice the diameter of the cable or conduit.
- 9.1 The current rating will be reduced if the cabling is bunched with others, surrounded by thermal loft or wall insulation or placed in areas where the ambient temperature is above 30°C. Under these conditions, derating factors apply and it is necessary to select a larger cable size.
- 9.2 In the majority of installations, the cable will unavoidably be placed in one or more of the above conditions. This being so, it is strongly recommended to use a minimum of 10mm cabling throughout the shower installation.
- 9.3 In any event, it is essential that individual site conditions are assessed by a competent electrician in order to determine the correct cable size and permissible circuit length.

Table B

**Twin and earth PVC insulated cable  
Current carrying capacity**

Installed in an insulated wall	In conduit trunking	Clipped direct or buried in a non-insulated wall
6mm <sup>2</sup> 32A	6mm <sup>2</sup> 38A	6mm <sup>2</sup> 46A
10mm <sup>2</sup> 43A	10mm <sup>2</sup> 52A	10mm <sup>2</sup> 63A
16mm <sup>2</sup> 57A	16mm <sup>2</sup> 69A	16mm <sup>2</sup> 85A

**Note:** Cable selection is dependent on derating factors

**\*The method below may be used by installers to determine the approximate size of the incoming cable.**

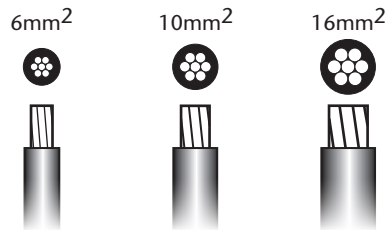

1. Measure the width of an individual strand, and half that measurement to find  $(r)$ , e.g:  $1.34\text{mm} \div 2 = (r) 0.67\text{mm}$
2. Multiply  $(r) \times (r) \times 3.14$ , e.g:  $(r) 0.67 \times (r) 0.67 \times 3.14 = 1.41\text{mm}^2$
3. Multiply this by the number of wire strands (usually 7), e.g:  $1.41\text{mm}^2 \times 7 = 9.87\text{mm}^2$ .
4. The number obtained would suggest  $10\text{mm}^2$  wiring.

**\*PLEASE NOTE:** If unsure, consult a qualified Electrician.

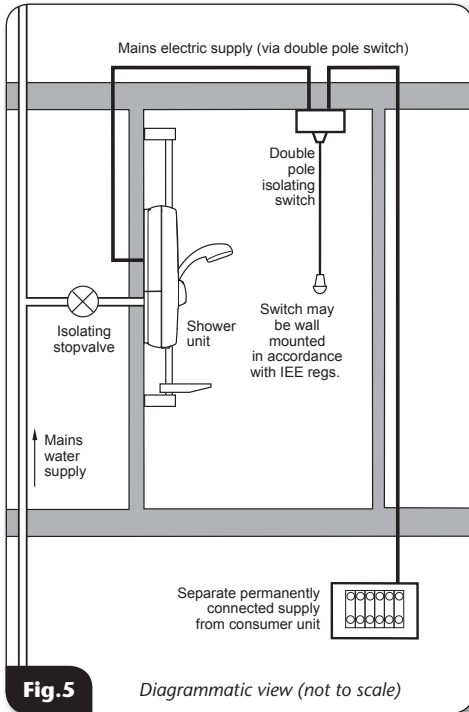

Fig.5

Diagrammatic view (not to scale)

### SITING OF THE SHOWER

The installation must be in accordance with Water Regulations/Bylaws - **see page 2 for water specifications**

- If it is intended to operate the shower at pressures above the maximum or below the minimum stated, contact Customer Service for advice.
- If the stated flow rates are not available, it may not be possible to achieve optimum performance from the unit throughout the year.
- During periods of high ambient temperatures it may be necessary to select the economy power setting to achieve your preferred shower temperature.

**Fig.5** shows a typical system layout.

- Refer to **(fig.6)** for the correct siting of the shower. Position the unit where it will **NOT** be in direct contact with water from the showerhead. Position the shower unit vertically.
- Allow enough room between the ceiling and the shower to access the cover top screws.
- Mark out entry points and routing of the water and electric supplies into the shower.

**IMPORTANT: Water regulations (fig.6)**

- It is required that the showerhead be 'constrained by a fixed or sliding attachment so that it can only discharge water at a point not less than 25mm above the spill-over level of the relevant bath, shower tray or other fixed appliance'.
- If the riser kit is supplied with a 'soapdish hose retainer' or bespoke 'hose retainer', it will in most cases meet this requirement. If the showerhead can still be placed within a bath, basin or shower tray within the 25mm limit, then a double check valve, or similar, **MUST be fitted in the supply pipework to prevent back-flow.**

**Pressure relief safety device**

- A pressure relief device (PRD) is designed into the shower unit which complies with European standards. The PRD provides a level of appliance protection should an excessive build up of pressure occur within the shower.

**DO NOT operate the shower with a damaged or kinked shower hose, or a blocked showerhead. This may cause the PRD to operate.**

- When commissioning, the showerhead must be removed from the flexible hose. Failure to follow this procedure may cause the PRD to operate.
- Make sure the shower is positioned over a bath or shower tray. If the PRD operates, then water will eject from the bottom of the unit. Should this happen, turn off the electricity and water supplies to the shower at the isolating switch and stopvalve. Contact Customer Service for advice on replacing the PRD.

**⚠ WARNING**

The shower **MUST NOT** be positioned where it will be subjected to freezing conditions.

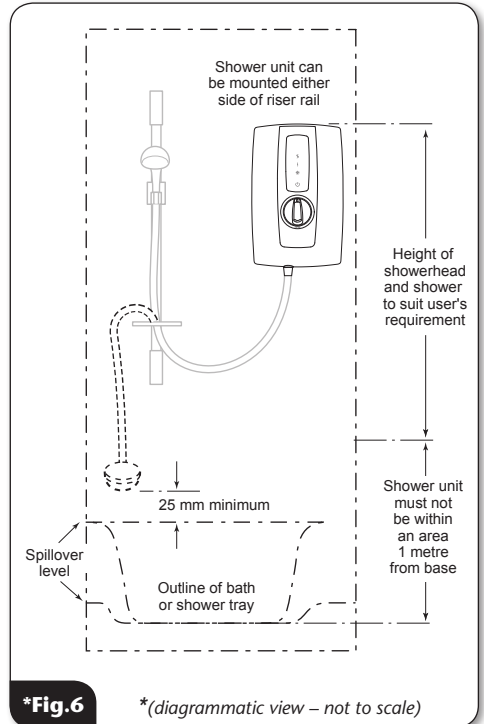

**IMPORTANT: If installing onto a tiled wall, ALWAYS mount the unit on the surface of the tiles. NEVER tile up to the unit.**

**IMPORTANT: The unit must be mounted on a flat surface which covers the full width and length of the backplate. It is important that the wall surface is flat otherwise difficulty may be encountered when fitting the cover and subsequent operation of the unit may be impaired.**

Fig.7

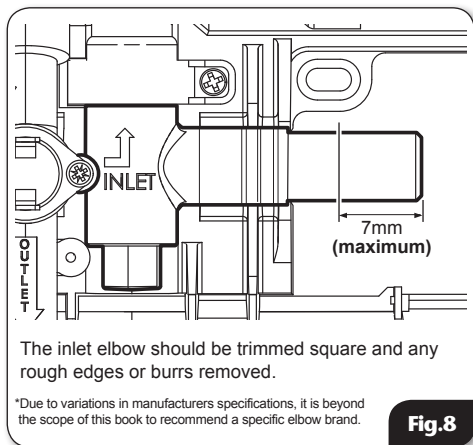
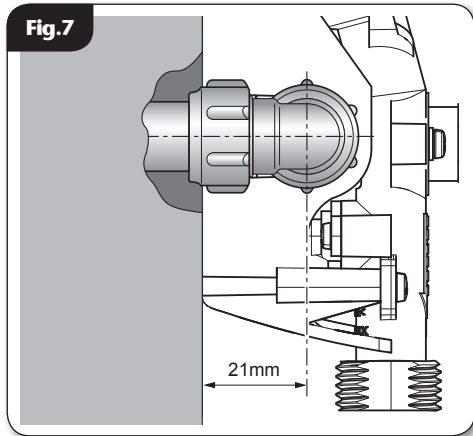

The inlet elbow should be trimmed square and any rough edges or burrs removed.

\*Due to variations in manufacturers specifications, it is beyond the scope of this book to recommend a specific elbow brand.

Fig.8

### IMPORTANT INFORMATION

The outlet of the shower acts as a vent and must not be connected to anything other than the hose and showerhead supplied.

### IMPORTANT!

The water inlet **MUST ONLY** be used in the 'Left' or 'Right' entry position. Under **NO CIRCUMSTANCES** should the water inlet fitting be used at 90° to the backplate to emulate a 'Rear Entry' installation.

## PLUMBING INSTALLATION

### Plumbing to be carried out before wiring

- **DO NOT** use jointing compounds on any pipe fittings for the installation.
- **DO NOT** solder fittings near the shower unit as heat can transfer along the pipework and damage components.
- Compression fittings **MUST** be used to connect to the inlet of the shower (**fig.7**). (Push-on fittings must **NOT** be used as full engagement cannot be guaranteed).
- If installing a feed pipe from the back or bottom, the centre of the inlet valve to the wall surface is 21mm (**fig.7**).
- **IMPORTANT LEFT OR RIGHT REAR ENTRY FITTING INFORMATION (fig.8).** Depending on the manufacturer of the \*90° compression fitting, the water inlet pipe may need to be trimmed (**by a maximum of 7mm**) to allow the main trim to be fitted correctly once the compression fitting is in place. It is advised to check positioning of the 90° compression fitting and main trim fit before any fittings are tightened.

**NOTE:** If entry is from the back, the nut of the compression fitting will be partially behind the surface of the wall. This area **MUST** be left clear when plastering and tiling around the pipework in order to make the nut accessible for future adjustments.

**NOTE:** An additional stopvalve (complying with Water Regulations) **MUST** be fitted in the mains water supply to the shower as an independent means of isolating the water supply should maintenance or servicing be necessary.

**IMPORTANT:** Before completing the connection of the water supply to the inlet of the shower, flush out the pipework to remove all swarf and system debris. This can be achieved by connecting a hose to the pipework and turning on the mains water supply long enough to clear the debris to waste.

**ELECTRICAL INSTALLATION**

**IMPORTANT:** Switch off the electricity supply at the mains before proceeding.

- The supply cable **MUST** be secured either by routing through conduit, in trunking, or by embedding in the wall, in accordance with IEE regulations.

**NOTE:** Conduit entry can only be from rear.

**NOTE:** Deviations from the designated entry points will invalidate product approvals. The cable entry points are listed on page 3.

- Seal around rear entry cable to prevent water ingress into the wall.

**FIT TO THE WALL & CONNECT THE SHOWER SUPPLIES****Pipe/Electrical access points**

Please see page 3 (fig.2) for specified inlet points.

- (fig.9) - Numbers 1, 2 and 3 are removable water/electrical entry trims.

**NOTE:** If top or bottom electrical entry is chosen with no water entry at that point, the removable trim should be cut to the shape of the incoming sheathing to minimise water ingress

**Fitting Procedure**

- Turn off water supply either at the mains stopvalve or the isolating stopvalve.
- Temporarily connect the mains water supply to the inlet of the shower using a 15mm x 15mm compression fitting.

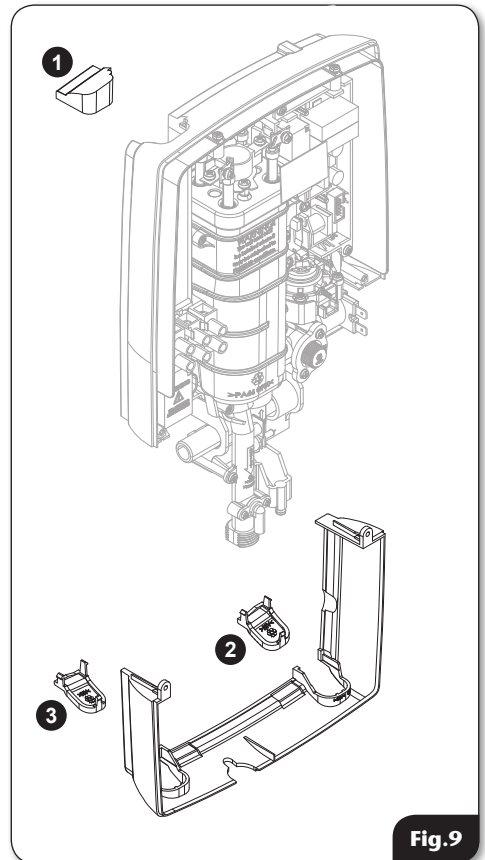
**Fig.9**

**PLEASE NOTE:** NONE of the 'cut outs' are designed to 'snap out'. **ONLY** a junior hacksaw or suitable knife should be used. Excessive damage to the backplate may invalidate product specifications and warranty.

Fig.10

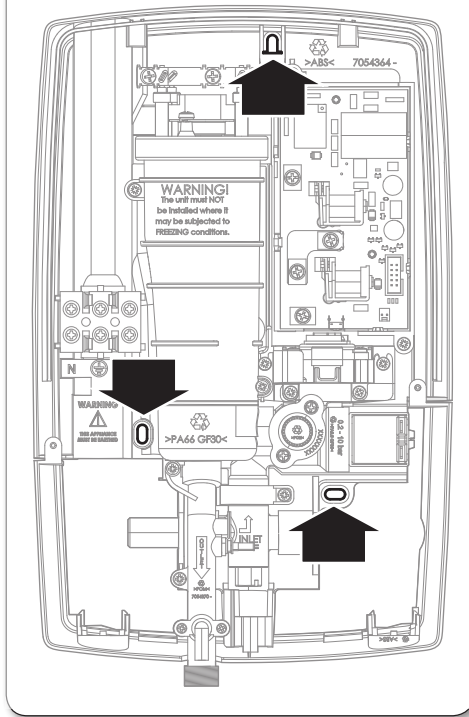

## ! WARNING

Check there are no hidden cables or pipes before drilling holes for wall plugs. Use great care when using power tools near water. The use of a residual current device (RCD) is recommended when using power tools.

- Remove the unit from the wall. Drill and plug the wall. (An appropriate drill bit should be used. If the wall is plasterboard or a soft building block, appropriate wall plugs should be fitted).
- Screw the top fixing screw into position leaving the base of the screw head protruding 6mm out from the wall.
- Hook the backplate over the top screw and fit the remaining fixing screws into position, but **DO NOT** fully tighten the screws at this stage. The fixing holes are elongated to allow for out of square adjustment after the plumbing connection has been completed.
- Connect the mains water supply to the inlet **DO NOT** use excessive force when making the connection.
- Make sure the backplate is square on the wall and tighten the retaining screws which hold it to the wall.
- Turn on the mains water supply and check for leaks in the pipework connection to the shower.

**NOTE:** At this stage no water can flow through the unit.

**IMPORTANT:** A suitable sealant should always be used to seal around the incoming pipework to prevent water entering the wall.

- Route the cable into the shower unit for connection to the terminal block (**fig.11**) as follows:

**Neutral** cable to terminal marked **N**

**Earth** cable to terminal marked 

**Live** cable to terminal marked **L**

- Once the cables have been installed the two triplates will need to be fitted.
- (**fig.12**) shows a schematic wiring diagram.

**IMPORTANT:** When connecting the cable fully tighten the terminal block screws and make sure that no cable insulation is trapped under the screws. Loose connections can result in cable overheating.

**NOTE:** The supply cable earth conductor must be sleeved. The outer sheath of the supply cable must be stripped back to the minimum.

- The use of connections within the unit or other points in the shower circuit to supply power to other equipment i.e. extractor fans, pumps etc. will invalidate the guarantee.
- DO NOT** switch on the electricity supply until the shower cover has been fitted.

**NOTE:** The elements on UK models are to 240V specification and will give a lower kW rating if the voltage supply is below 240V.

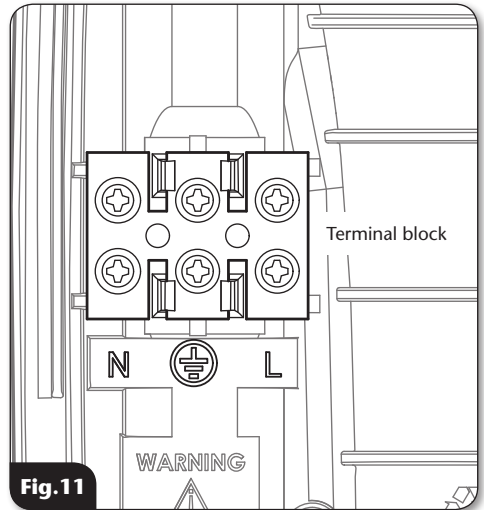

**Fig.11**

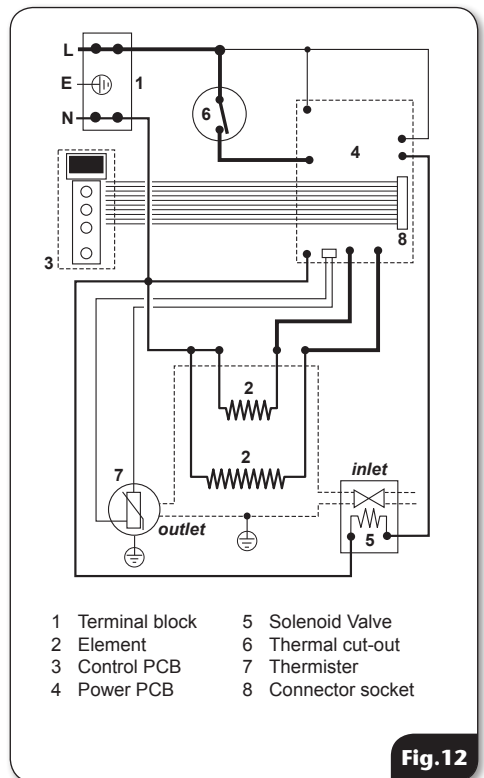

**Fig.12**

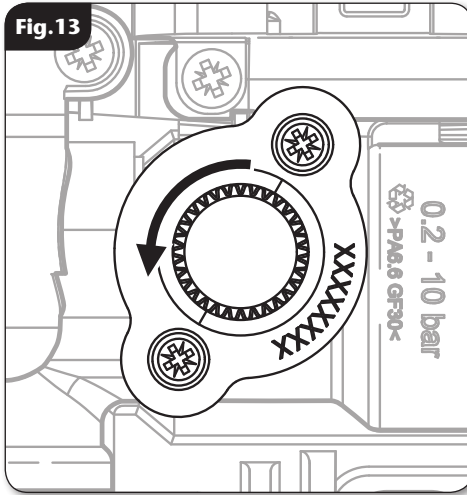

Fig. 13

**PLEASE NOTE**

Before normal operation of the shower, it is essential the following commissioning procedure is completed correctly.

**⚠ IMPORTANT ⚠**

**DO NOT** connect the 10-way ribbon cable before the commissioning procedure has been completed.

**FITTING THE COVER****Fitting The Cover - valve & knob positions**

- Turn the valve spindle anti-clockwise until it stops (**fig.13**).
- Fit the trimplate.
- Turn the temperature control on the cover fully anti-clockwise until it stops (**fig.14**).
- Offer the cover to the unit.
- Carefully locate the cover tags into the guide pockets on the backplate and make sure the wires are not trapped.
- Guide the cover into position so that the control spindle locates correctly (minor adjustment may be necessary to align the control and spindle).
- Should any difficulty arise, recheck the points above.
- While applying slight pressure to the front cover, secure in position with the retaining screws.
- Fit the flexible hose to the shower outlet making sure the outlet of the hose is directed to waste. Check the supplied sealing washer is in place.
- **DO NOT attach the showerhead at this stage.**

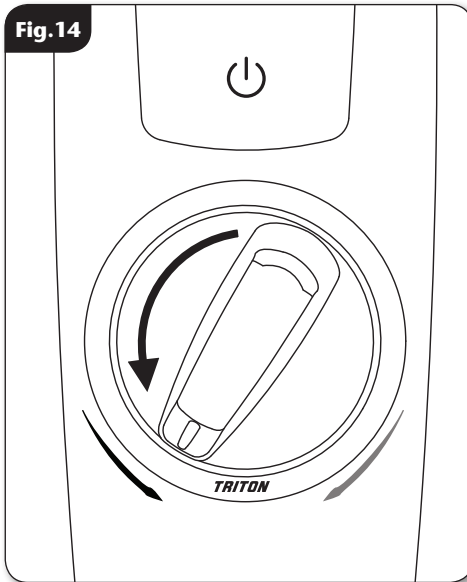

Fig. 14

**⚠ WARNING ⚠****COVER RETAINING SCREWS**

**ONLY** the **SUPPLIED SCREWS** should be used. The use of none supplied screws **WILL** invalidate product specifications & warranty.



**WARNING**

Before normal operation of the shower, it is essential the following commissioning procedure is completed correctly.

**COMMISSIONING PROCEDURE**

The first operation of the shower is intended to flush out any remaining unit debris, and to make sure the heater unit contains water before the elements are switched on.

This operation **MUST** be carried out **WITH** the flexible hose screwed to the outlet but **WITHOUT THE SHOWERHEAD ATTACHED**. Make sure the outlet of the flexible hose is directed to waste.

**IMPORTANT:** The Temperature control **MUST** be turned fully **clockwise** as shown in (fig.15) - **Failure to do this could make the PRD operate.**

- Turn on the water supply to the shower at the isolating stop valve.
- Switch on the electricity supply to the shower at the isolating switch.
- Wait until water starts to flow from the flexible hose.
- Slowly rotate the temperature control fully anti-clockwise as in (fig.16).
- It will take about thirty seconds for a smooth flow of water to be obtained while air and any debris is being flushed from the shower
- When a smooth flow of water is obtained, turn the temperature control fully clockwise and anti-clockwise and back again several times to release any trapped air from within the unit.
- Once the flushing out has been completed, switch off the electricity to the shower at the isolating switch. The water will cease to flow.
- Unscrew the top and bottom retaining screws again, and lift the cover from the backplate.

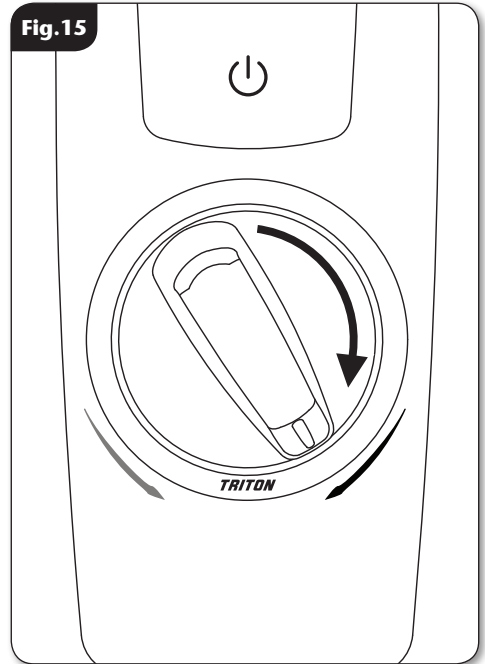
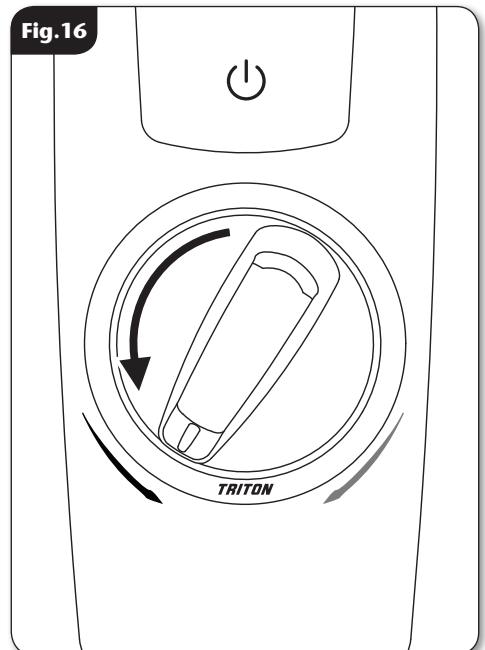
**Fig.15****Fig.16**

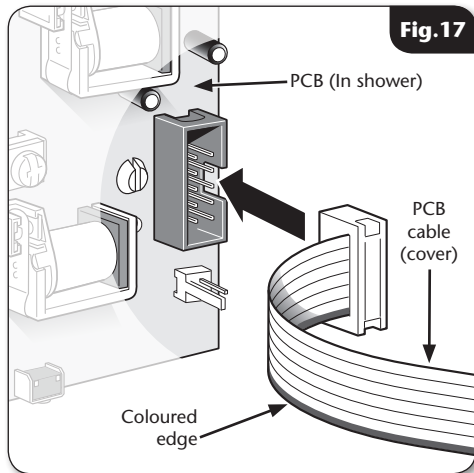

## CONNECTING THE PCB CABLE & REFITTING THE COVER

**IMPORTANT:** After connecting the PCB cable, please check the following before refitting the cover:

1. All plumbing connections are watertight.
  2. Terminal block screws are fully tightened.
  3. Make sure the pipe and cable entering the unit do not prevent the cover locating correctly onto the backplate.
  4. Check that the top rubber seal is in place on the inside of the cover.
- See (fig.13 & 14 on page 12) for the correct positions of the temperature spindle and temperature knob.
  - **Attached to the display PCB, inside the cover, is a 10-way ribbon cable. The ribbon cable connector must be plugged into the socket located at the right of the power PCB situated inside the unit (fig.17).**
  - **The cable connector can only be fitted into the socket in one way. The ribbon cable has a coloured edge which is lowermost when correctly fitted to the socket.**
  - Guide the cover into position so that the knob spindle locates correctly (minor adjustment may be necessary to align the knob and spindle). Should any difficulty arise, re check the points above.
  - While applying slight pressure to the cover, secure in position with the retaining screws.
  - Turn the electric supply back on at the isolating switch. The 'Power on' indicator will light.
  - Water will **NOT** flow until the Start/Stop icon is touched.
  - It is recommended that the water and electric supplies to the shower are turned off while the riser rail kit is being installed.
  - The flexible hose can be left attached to the shower outlet. Make sure the supplied sealing washer is fitted.

**OPERATING THE SHOWER**

**PLEASE NOTE**

The touch controls will run a calibration cycle for a few seconds when the 'power on' indicator ring illuminates.

The start/stop icon will not activate the shower until calibration has finished.

**To start the shower (fig.18)**

- Switch the power on at the isolating switch. The **power 'on'** indicator ring of light around the Start/Stop icon will illuminate.
- Touch the Start/Stop icon and the Display Screen will illuminate and 'Hello' will be displayed for a few seconds. The display will then change to show the showering temperature. The shower will start on the **High (Max)** setting. The 'Mode Indicator' bars will illuminate either side of the High (Max) icon.
- Once the shower is running, the **Economy (Eco)** or **Cold** icon may be touched to change the setting from the default startup of High (Max).
- When a new temperature selection is made, the 'Mode Indicator' bars illuminate next to the appropriate icon and the screen will display 'Cold', 'Eco' or 'Max' to denote the selection before displaying the showering temperature.
- If at any point the icon with the lit 'Mode Indicator' bars is touched again, it will display the appropriate word for the setting for a few seconds.

**To stop the shower**

- The shower should be stopped by touching the **Start/Stop** icon. When touched, the words 'shutting down' will begin to flash on the Display Screen and water will cease to flow after a few seconds. (see *phased shutdown process, P17*).
- The Display Screen will then display 'goodbye' and the Display Screen will turn itself off.
- After shutdown the unit **MUST** be isolated via the 45amp-isolating switch.

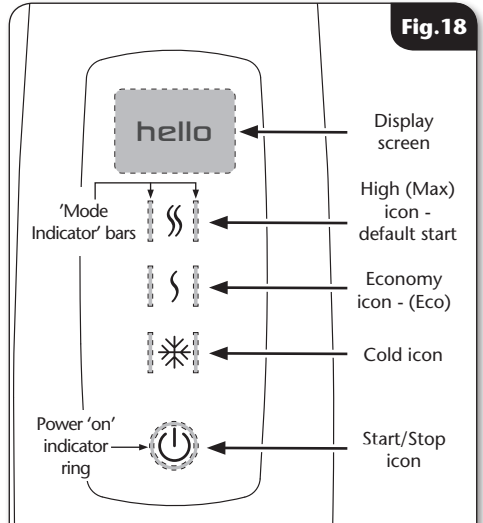

**PLEASE NOTE:** The Power 'on' indicator ring will only become visible once the isolating switch power is turned on to the shower.

The 'Mode Indicator' bars for the temperature settings and the 'Display Screen' will NOT be visible until the Start/Stop icon is touched and the shower has been started.

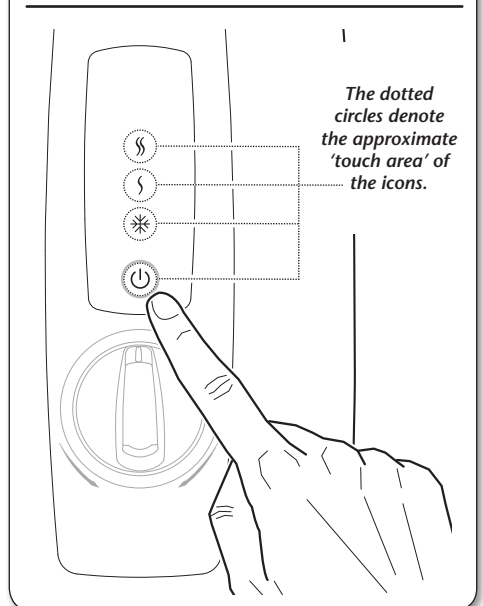

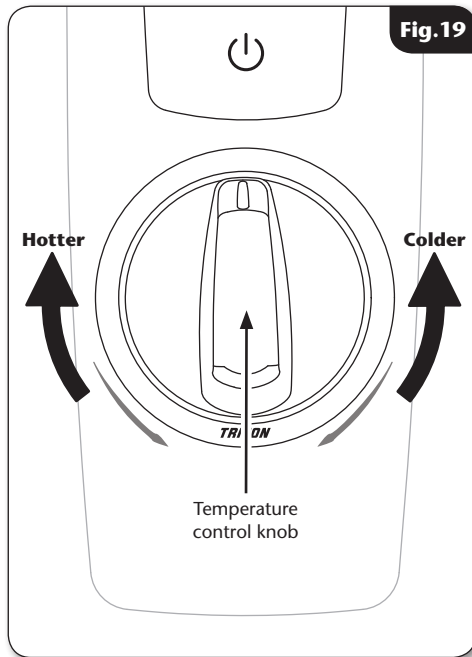

**Cold setting** - blue indicator

- **Cold:** No heat is applied to incoming water.

**Economy (Eco) setting** - single red indicator

- **Economy:** Only one of the elements within the heater can be used.

**High (Max) setting** - double red indicator

- **High:** Both of the elements within the heater can be used.

**IMPORTANT:** *it will take a few seconds for the temperature to stabilise once changes have been made.*

**To adjust the shower temperature - Economy (Eco) and High (Max) settings only (fig.19)**

- The water temperature is altered by increasing or decreasing the flow rate of the water through the shower via the temperature control knob.
- After obtaining your showering temperature, the knob can be left as the normal setting and should only need altering to compensate for seasonal changes in ambient water temperature.

**NOTE:** *The preferred knob position on ECONOMY will give a different temperature to the same position on HIGH.*

**To decrease the shower temperature**

- Turn the temperature control knob **anti-clockwise** - this will increase the flow of water through the shower and make the water **colder**. The Display Screen will display the drop in temperature.

**To increase the shower temperature**

- Turn the temperature control **clockwise** - this will decrease the flow of water through the shower and make the water **hotter**. The Display Screen will display the increase in temperature.

**NOTE:** *It is advisable that the showering temperature is satisfactory by testing with your hand before stepping under the showerhead. There will always be a time delay of a few seconds between selecting a flow rate and the water reaching the stable temperature for that flow rate.*

## OPERATING FUNCTIONS

### Power 'on' indicator ring (fig.20)

- When the electricity supply to the shower is switched on at the isolating switch, the power indicator ring that surrounds the Start/Stop icon will light up and become visible.

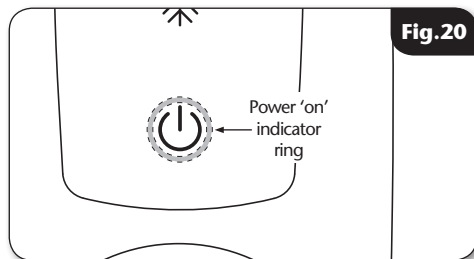

Fig.20

### Low pressure indication (fig.21)

If the water pressure has fallen below the minimum required for correct operation of the shower, the following will happen.

- The power to the heating elements will be switched off, preventing any undue temperature rises.
- The shower will operate on the COLD setting and the Display Screen will flash 'low pressure'.
- When there is adequate water pressure, the unit automatically restores the power to the elements and returns to the original setting selected. The Display Screen will revert to the water temperature again.

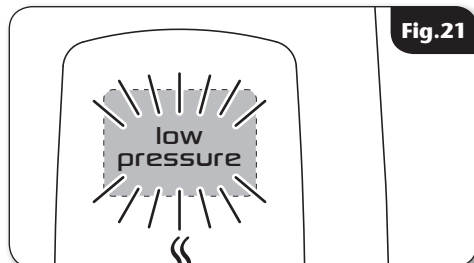

Fig.21

### Phased shutdown (fig.22)

- When the shower is in use and the **Start/Stop** icon is touched, power is switched off to the elements. Water will continue to flow for a few seconds, flushing out any remaining hot water. This makes sure the next immediate user will not receive a slug of hot water if standing under the showerhead when starting the shower. While the phased shutdown operation is in progress, the Display Screen will flash 'shutting down'.
- When the operation is complete, the Display Screen will show the word 'goodbye'. The word will gradually fade, and the Display Screen will turn off.

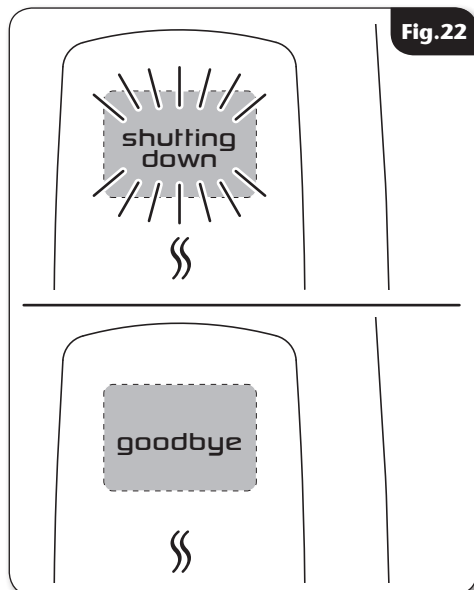

Fig.22

### \*Safety cut-out

- The unit is fitted with an over-temperature safety device. In the event of abnormal operation which could cause unsafe temperatures within the unit, the device will disconnect the heating elements.

### Lo/Hi Out of temperature range message

- If the display shows the words 'Lo' or 'Hi' at any time, it means that the showers is outside optimum showering temperatures. Wait until the screen shows the appropriate temperature before continuing to shower.

### \*PLEASE NOTE

It will require a visit from a qualified engineer to identify the nature of the fault and replace the safety device.

## Instructions for installers and service engineers only

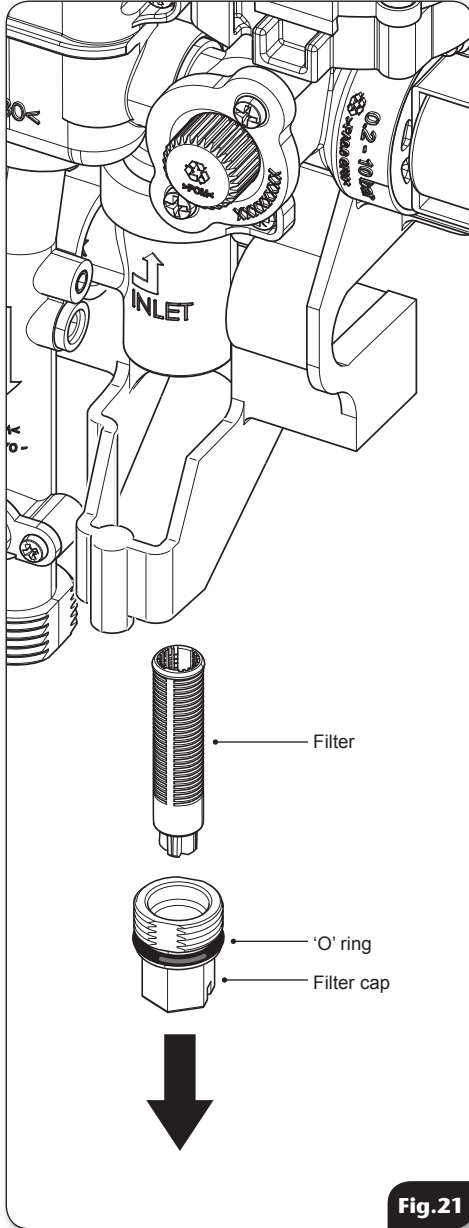

### CLEANING THE FILTER

It is recommended that the filter is periodically cleaned in order to maintain the performance of the shower. It is essential that this operation is carried out by a competent person.

- **SWITCH OFF** the electricity and water supply at the mains.
- The inlet filter is situated inside the water inlet fitting (**fig.21**).
- To gain access to the filter, remove the cover and bottom trimplate.
- Unscrew the filter cap from the bottom of the inlet pipe.
- Inspect the 'O' ring for damage when the filter cap is removed.
- When cleaning the filter, **DO NOT** use a sharp object, as it will cause damage. It is preferable to use an old toothbrush or similar.
- To reassemble, follow the procedure in reverse.
- Make sure that the sealing 'O' ring is in place.
- **DO NOT** over tighten the filter cap on reassembly.

## FAULT FINDING/TROUBLESHOOTING

**Important:** Switch off the electricity at the mains supply and remove the circuit fuse before attempting any fault finding inside the unit.

Problem/Symptom	Cause	Action/Cure
<b>1</b> Shower inoperable, no water flow.	<b>1.1</b> Interrupted power supply.	<b>1.1.1</b> Blown fuse or circuit breaker. Check supply Renew or reset fuse or circuit breaker. If it fails again, consult a qualified electrician.
	<b>1.2</b> Unit malfunction.	<b>1.2.1</b> Power cut? Check other appliances and if necessary, contact local Electricity Supply Co.
		<b>1.2.2</b> Have unit checked. Ring Customer Service.
	<b>1.3</b> Thermal cut-out operated.	<b>1.3.1</b> The thermal cut-out safety device has operated. Have the unit checked by a suitably qualified service engineer or contact Customer Service.
<b>2</b> Water too hot.	<b>2.1</b> Not enough water flowing through the shower.	<b>2.1.1</b> Increase flow rate via temperature control.
		<b>2.1.2</b> Blocked showerhead — clean or replace blocked sprayplate in showerhead.
	<b>2.2</b> Blockage in supply.	<b>2.2.1</b> Check if stop valves are fully open. Check if a blockage in the inlet filter.
	<b>2.3</b> Increase in ambient water temperature.	<b>2.3.1</b> Readjust flow rate to give increased flow.
		<b>2.3.2</b> Select 'economy' power.
<b>3</b> Water too cool or cold.	<b>3.1</b> Too much flow.	<b>3.1.1</b> Reduce flow rate via temperature control.
	<b>3.2</b> Water pressure below minimum required ( <i>see rating label</i> ).	<b>3.2.1</b> Is water supply mains or tank fed?
		<b>3.2.2</b> If tank fed, replumb to mains water supply or <i>see 3.2.4</i> .
		<b>3.2.3</b> If mains fed, make sure that mains stopvalve is fully open and that there are no other restrictions in the supply while shower is in use, or <i>see 3.2.4</i> .
		<b>3.2.4</b> Fit pump to give minimum pressure ( <i>see rating label</i> ). Contact Customer Service for advice.

## FAULT FINDING/TROUBLESHOOTING

**Important:** Switch off the electricity at the mains supply and remove the circuit fuse before attempting any fault finding inside the unit.

Problem/Symptom	Cause	Action/Cure
3 Water too cool or cold - <i>continued</i>	3.3 Reduction in ambient water temperature.	3.3.1 Readjust flow rate to give reduced flow. 3.3.2 Select 'high' power.
	3.4 Electrical malfunction.	3.4.1 Have unit checked by suitably qualified electrician or contact Customer Service.
	3.5 Safety cut-out operated.	3.5.1 Thermal safety cut-out device has operated. Have the unit checked by a suitably qualified engineer or contact Customer Service.
4 Pressure relief device has operated.	4.1 Blocked showerhead.	4.1.1 Clean sprayplate and then fit a new PRD.
	4.2 Twisted/blocked flexible shower hose.	4.2.1 Check for free passage through hose. Replace hose if necessary and then fit new PRD.
	4.3 Showerhead not removed while commissioning.	4.3.1 Fit new PRD. Commission unit with showerhead removed.
5 'Low Pressure' flashing on Display Screen.	5.1 Low pressure condition.	5.1.1 Insufficient water flow available. 1. Check filter is not blocked. 2. Check water supply to shower is adequate

**NOTE:** *Identify cause of operation before fitting new PRD unit.  
When fitting a new PRD, follow the commissioning procedure.*

**It is advised all electrical maintenance/repairs to the shower should be carried out by a suitably qualified person.**

**In the unlikely event of a fault occurring please contact Triton Customer Service.  
DO NOT remove the shower from the installation.**



**SPARE PARTS**

- 1. Thermal cut-out (TCO) .....22012750
- 2. Heater & deflector assembly  
8.5kW.....83314510  
9.5kW.....83314520
- 3. Solenoid & .....P27410800  
valve assembly
- 4. Pressure switch assembly .....P26810803
- 5. Pressure relief.....82800450  
device assembly
- 6. Terminal block.....S82201270  
& wires assembly
- 7. Inlet filter assembly.....S27411001
- 8. Outlet pipe assembly.....S85000280
- 9. Trimplate  
White.....7054365
- 10. Power PCB.....7073742
- 11. Cover & PCB assembly  
White.....S80000017
- Bottom LH pipe trim  
White.....7054373
- Bottom RH pipe trim  
White.....7054374
- Top pipe trim  
White.....7054371

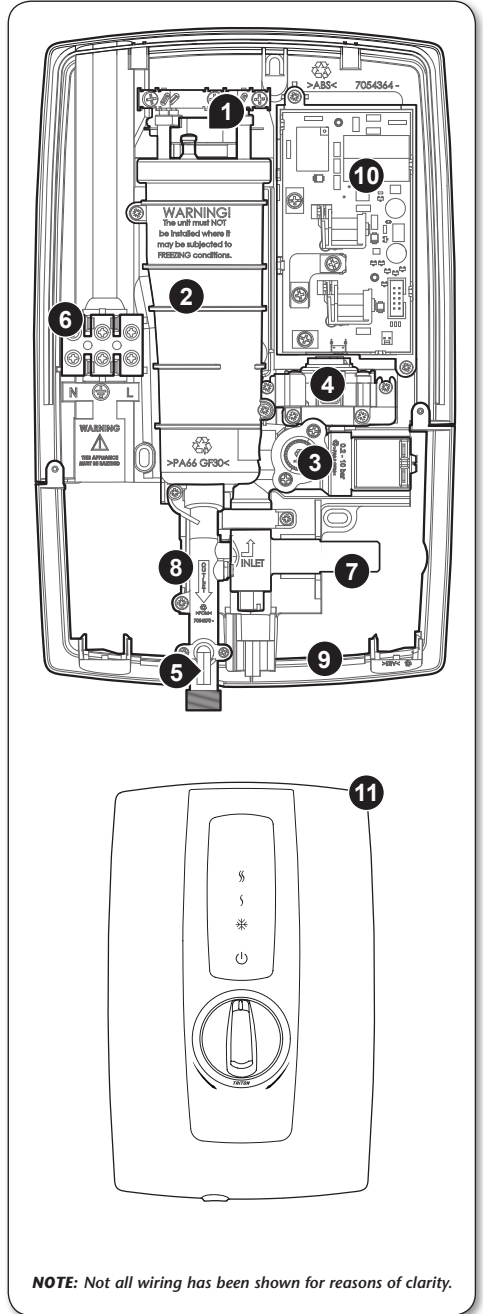

**NOTE:** Not all wiring has been shown for reasons of clarity.

## WEEE Directive – Policy Statement

As a producer and a supplier of electric showers, Triton Showers is committed to the protection of the environment via our own environmental policy and the compliance with the **WEEE directive**.

Triton Showers is fully registered with the Environment Agency under the following schemes:

Repic: Producers take-back scheme (PTS), registration number WEE/EJ3466QV

Valpak: Distributor take-back scheme (DTS), registration number 9659

All our electric products are labelled accordingly with the crossed out wheeled bin symbol. This indicates, for disposal purposes at end of life, that these products must be taken to a recognised collection points, such as local authority sites/local recycling centres; this will be free of any charges. **Do not return to Triton Showers.**



# SHOWER CONTROLS - QUICK USER GUIDE

## To START or STOP your shower.

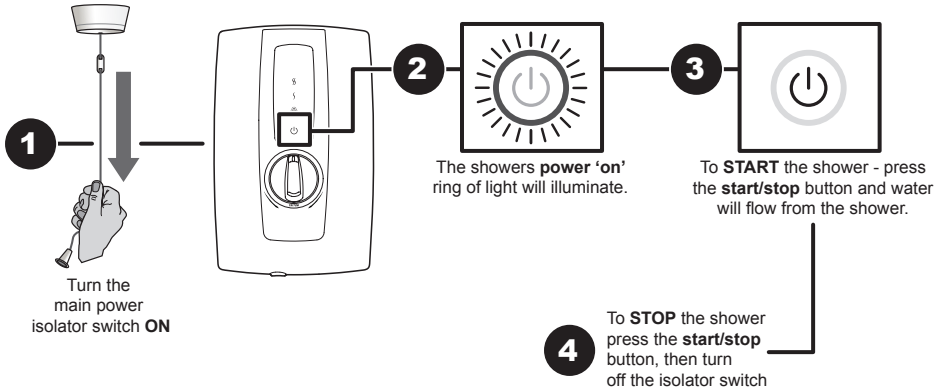

## To alter the FLOW and TEMPERATURE of your shower.

### Select a Temperature Button setting

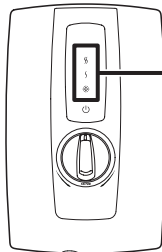

HIGH (Max) default setting



=

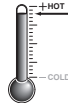

ECONOMY (Eco)



=

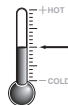
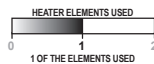

COLD water



=

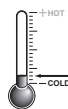
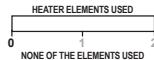

### Select a Temperature Knob setting

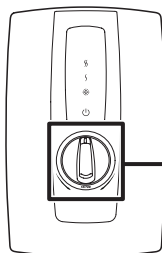

HOTTER (slower flow)



=

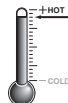

COLDER (faster flow)



=

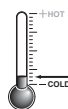

## UK SERVICE POLICY

In the event of a product fault or complaint occurring, the following procedure should be followed:

1. Telephone Customer Service on **0844 980 0750** having available, your details including post code, the model number and power rating of the product, together with the date of purchase and, where applicable, details of the particular fault.
2. If required, the Customer Service Advisor will arrange for a qualified engineer to call.
3. All products attended to by a Triton service engineer must be installed in full accordance with the Triton installation guide applicable to the product. *(Every product pack contains an installation guide, however, they can also be bought via our Customer Service Spares Department).*
4. Our engineer will require local parking and if a permit is required this must be available to the engineer on arrival at the call.
5. It is essential that you or an appointed representative (*who must be over 18 years of age*) is present for the duration of the service engineer's visit. If the product is in guarantee you must produce proof of purchase.
6. Where a call under the terms of guarantee has been booked and the failure is not product related (*i.e. scaling and furring, incorrect water pressure, pressure relief device operation or electrical/plumbing installation fault*) a charge will be made. A charge will also be issued if nobody is at home when the service engineer calls or adequate parking/permit is not available.
7. If the product is no longer covered by the guarantee an up front fixed fee will be charged before the site visit.
8. Should proof of purchase not be available on an "in-guarantee" call, or should the service engineer find that the product is no longer under guarantee, the engineer will charge the same fixed price and the customer will be expected to pay the engineer before he leaves. If payment is not made on the day an administration charge will be added to the fixed charge.
9. If a debt is outstanding from a previous visit, or from any other Triton purchase, Triton reserves the right to withhold service until the debt has been settled.
10. Triton takes the health, safety and wellbeing of its employees very seriously and expects customers to treat all staff members with respect. Should any employee feel threatened or receive abuse, either verbally or physically, Triton reserves the right to withhold service and will support the employee with a legal prosecution.

## Replacement Parts Policy

**Availability:** It is the policy of the manufacturer to maintain parts availability for the duration of production and a period of five years thereafter, in accordance with industry standards.

Spare parts are available via our website, [www.tritonshowers.co.uk](http://www.tritonshowers.co.uk), or by telephoning Triton Customer Service Spares Department. Payment should be made by credit/debit card (excluding American Express or Diners Card). Payment can also be made by pre-payment of a pro forma invoice by cheque or money order.

Telephone orders are based on information given during of the call.

**Before contacting Triton, please verify your requirements using the information contained in the supplied user guide. Triton cannot accept liability for incorrect part identification.**

## TRITON STANDARD GUARANTEE

With the exception of accessories, Triton guarantee the product against all manufacturing defects for a period of **2 years** (for domestic use only) from the date of purchase, provided that it has been installed by a competent person in full accordance with the fitting instructions.

All accessories such as shower heads, hoses and riser rails carry a **1 year** parts only guarantee against manufacturing defects.

Any part found to be defective during this guarantee period we undertake to repair or replace at our option without charge so long as it has been properly maintained and operated in accordance with the operating instructions, and has not been subject to misuse or damage. This product must not be taken apart, modified or repaired except by a person authorised by Triton. This guarantee applies only to products installed within the United Kingdom and does not apply to products used commercially. This guarantee does not affect your statutory rights.

### What is not covered:

1. Breakdown due to: **a)** use other than domestic use by you or your resident family; **b)** wilful act or neglect; **c)** any malfunction resulting from the incorrect use or quality of electricity, gas or water or incorrect setting of controls; **d)** failure to install in accordance with this installation guide
2. Claims for missing parts once the product has been installed.
3. Repair costs for damage caused by foreign objects or substances.
4. Total loss of the product due to non-availability of parts.
5. Compensation for loss of use of the product or consequential loss of any kind.
6. Call out charges where no fault has been found with the appliance.
7. The cost of repair or replacement of pressure relief devices, showerheads, hoses, riser rails and/or wall brackets, isolating switches, electrical cable, fuses and/or circuit breakers or any other accessories installed at the same time.
8. The cost of routine maintenance, adjustments, overhaul modifications or loss or damage arising therefrom, including the cost of repairing damage, breakdown, malfunction caused by corrosion, furring,
9. Call out charges where the water supply cannot be isolated, this includes consequential losses arising from unserviceable supply valves.

**For the latest Terms & Conditions, please see:**  
[www.tritonshowers.co.uk](http://www.tritonshowers.co.uk)

Triton Showers  
Triton Road  
Nuneaton  
Warwickshire CV11 4NR

*Triton is a division of Norcross Group (Holdings) Limited*

**Customer Service:** ☎ **0844 980 0750**

**Trade Installer Hotline:** ☎ **0844 980 0730**

**Fax:** **0844 980 0744**

[www.tritonshowers.co.uk](http://www.tritonshowers.co.uk)

**E-mail:** [serviceenquiries@tritonshowers.co.uk](mailto:serviceenquiries@tritonshowers.co.uk)

**Extended Warranty AVAILABLE NOW. Call 0844 980 0740 for more details.**