

Erbauer®

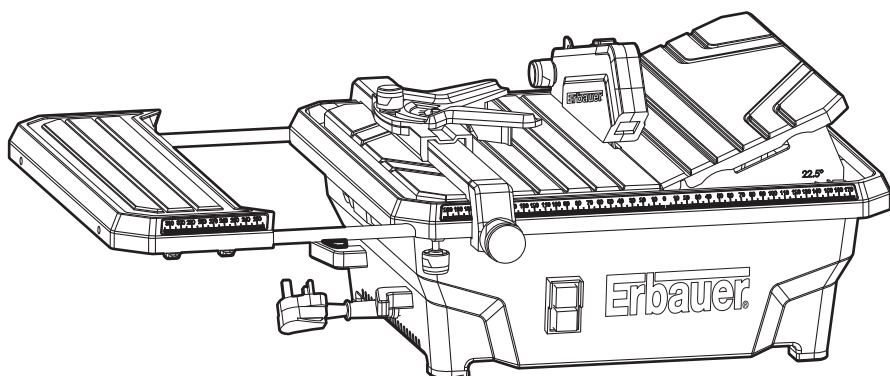

ERB337TCB

2 WARRANTY
YEARS

Original Instructions

SAFETY AND OPERATING MANUAL

ERBAUER 750W TILE CUTTER



Erbauer®

Congratulations on your purchase of a quality power tool from Erbauer (UK) Ltd. This product should give you reliable service but for your peace of mind this Erbauer power tool does carries a 24-month guarantee, the terms of which are detailed below.

If this product develops a fault within the guarantee period contact your retailer.

Please retain this handbook in case you need to refer to safety, care or guarantee information in the future.

GUARANTEE

This Erbauer product carries a guarantee of 24 months. If your product develops a fault within this period, you should in the first instance contact the retailer where the item was purchased.

This guarantee specifically excludes losses caused due to:

- Fair wear and tear
- Misuse or abuse
- Lack of routine maintenance
- Failure of consumable items (such as batteries)
- Accidental damage
- Cosmetic damage
- Failure to follow manufacturer's guidelines
- Loss of use of the goods

This guarantee does not affect your statutory rights. This guarantee is only valid in the UK.

For further technical advice, spare parts or repair service (outside of guarantee) please contact your retailer quoting your Erbauer model number

GENERAL SAFETY INSTRUCTIONS



WARNING! Read all instructions Failure to follow all instructions listed below may result in electric shock, fire and/or serious injury. The term "power tool" in all of the warnings listed below refers to your mains operated (corded) power tool or battery operated (cordless) power tool.

SAVE THESE INSTRUCTIONS

- 1. Keep work area clear.** Cluttered areas and benches invite injuries.
- 2. Consider work area environment Do not expose tools to rain. Do not use tools in damp or wet locations. Keep work area well lit.** Do not use tools in the presence of flammable liquids or gases.
- 3. Guard against electric shock Avoid body contact with earthed or grounded surfaces (e.g. pipes, radiators, ranges, refrigerators).**
- 4. Keep other persons away.** Do not let persons, especially children, not involved in the work touch the tool or the extension cord and keep them away from the work area.
- 5. Store idle tools.** When not in use, tools should be stored in a dry locked-up place, out of reach of children.
- 6. Do not force the tool.** It will do the job better and safer at the rate for which it was intended.
- 7. Use the right tool. Do not force small tools to do the job of a heavy duty tool.** Do not use tools for purposes not intended; for example do not use circular saws to cut free limbs or logs.
- 8. Dress properly. Do not wear loose clothing or jewellery, they can be caught in moving parts. Non-skilled footwear is recommended when working out doors.** Wear protective hair covering to contain long hair.
- 9. Use protective equipment. Use safety glasses.** Use face or dusk mask if working operations create dust.
- 10. Connect dust extraction equipment.** If the tool is provided for the connection of dust extraction and collecting equipment, ensure these are connected and properly used.
- 11. Do not abuse the cord. Never yank the cord to disconnect it from the socket.** Keep the cord away from heat, oil and sharp edges.
- 12. Secure work. Where possible use clamps or a vice to hold the work.** It is safer than using your hand.
- 13. Do not overreach.** Keep proper footing and balance at all times.
- 14. Maintain tools with care. Keep cutting tools sharp and clean for better and safer performance. Follow instruction for lubricating and changing accessories. Inspect tool cords periodically and if damaged have them repaired by an authorised service facility. Inspect extension cords**

periodically and replace if damaged. Keep handles dry, clean and free from oil and grease.

- 15. Disconnect tools.** When not in use, before servicing and when changing accessories such as blades, bits and cutters, disconnect tools from the power supply.
- 16. Remove adjusting keys and wrenches.** Form the habit of checking to see that keys and adjusting wrenches are removed from the tool before turning it on.
- 17. Aboid unintentional starting.** Ensure switch is in "off" position when plugging in.
- 18. Use outdoor extension leads.** When the tool is used outdoors, use only extension cords intended for outdoor use and so marked.
- 19. Stay alert.** Watch what you are doing, use common sense and do not operate the tool when you are tired.
- 20. Stay alert. Check damaged parts. Before further use of tool, it should be carefully checked to determine that it will operate properly and perform its intended function. Check for alignment of moving parts, binding of moving parts, breakage of parts, mounting and any other conditions that may affect its operation. A guard or other part that is damaged should be properly repaired or replaced by an authorised service centre unless otherwise indicated in this instruction manual. Have defective switches replaced by an authorised service centre.** Do not use the tool if the switch does not turn it on and off.
- 21. Warning.** The use of any accessory or attachment other than one recommended in this instruction manual may present a risk of personal injury.
- 22. Have your tool repaired by a qualified person. This electric tool complies with the relevant safety rules.** Repairs should only be carried out by qualified persons using original spare parts, otherwise this may result in considerable danger to the user.

ADDITIONAL SAFETY RULES FOR TILE CUTTERS

- The machine must be supplied through a residual current device (RCD) having a rated residual operating current not exceeding 30 mA.
- Do not use diamond discs which are damaged or deformed.
- Replace table insert when worn.
- Use only diamond discs recommended by the manufacturer.
- Take care that the selection of the diamond discs is suitable for the material to be cut.
- Wear suitable personal protective equipment when necessary, this could include hearing protection to reduce the risk of induced hearing loss, respiratory protection to reduce the risk of inhalation of harmful dust, wear gloves when handling diamond discs and rough material.
- Never use blades on this machine.
- Use only diamond discs for which the maximum possible speed is not less than

the maximum spindle speed of the tool and the material to be cut.

- Faults in the machine, including guards or diamond discs, should be reported as soon as they are discovered. Never use the machine without the guard in position.
- Maximum size of working piece should be 1m².
- This tile cutter should be used with limitations on ambient conditions (between 15°C and 30°C).

Wear goggles

Wear ear defenders

Wear a breathing mask

Wear gloves

SYMBOLS

The rating plate on your tool may show symbols. These represent important information about the product or instructions on its use.



Wear hearing protection.
Wear eye protection.
Wear respiratory protection.



WARNING – To reduce the risk of injury, user must read instruction manual.



Conforms to relevant safety standards



Caution, risk of cutting



Use only non fragmented discs



Hand protection shall be worn

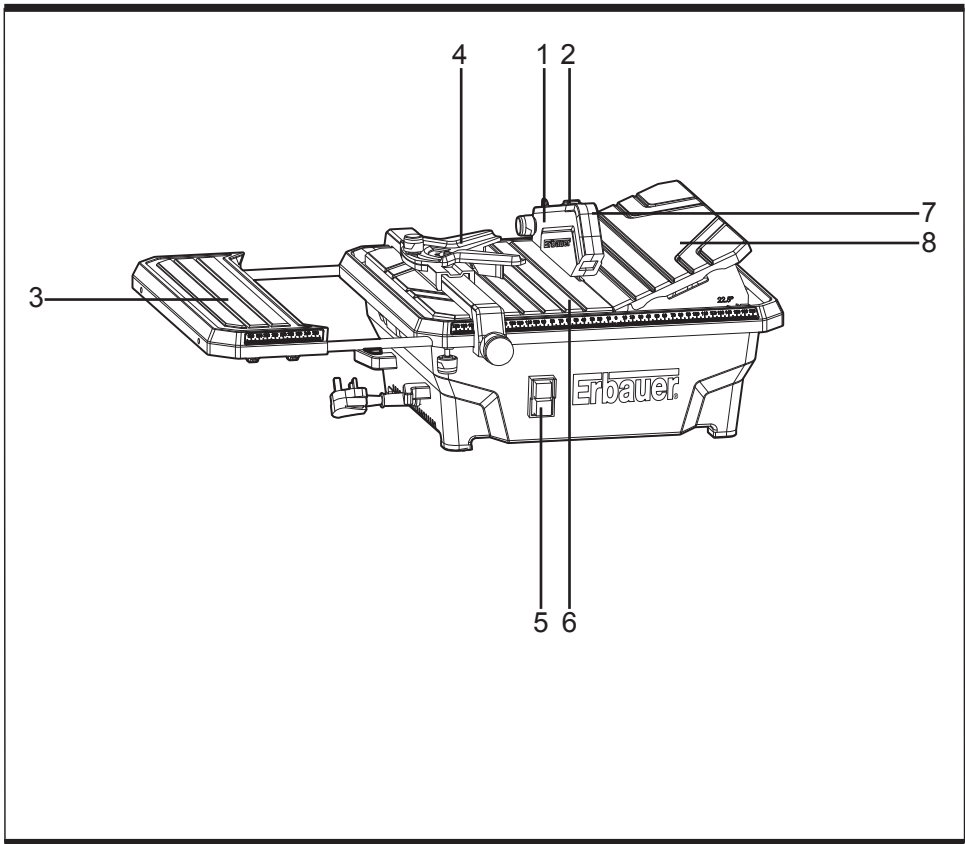

1. Protective guard

2. Laser light On/Off switch

3. Extension table

4. Mitre cutting guide

5. On/Off switch

6. Working table

7. Laser battery box

8. Vertical fence

CARACTERISTIQUES TECHNIQUES

Rated voltage and frequency	230-240V~50Hz
Rated power	750W S2:10min
No load speed	3000/min
Insulation class	Class I
Dimensions of the diamond disc	ø180mmx2.4mmxø22.2mm
Weight	12.0kg
Working table size	380x400mm
Working table with extension table size	440x580mm
Maximum cutting depth	30mm
Laser Class	II
Laser wave length	650nm

NOISE

A weighted sound pressure LpA	93.5dB(A)
A weighted sound power: LwA	103.2db(A)
Uncertainty	3dB(A)

The sound intensity level for the operator may exceed 85dB(A) and sound protection measures are necessary.

ACCESSORIES

The tile cutter is supplied with following accessories:

Mitre cutting guide	1pc
Parallel guide	1pc
45° vertical fence	1pc
Blade	1pc
Spanners	2pc
Water reservoir plug	1pc
Extension work table	1pc

OPERATION INSTRUCTIONS

This tile cutter shall be used only to cut tiles to a required size or shape. It shall not be used to cut inflammable, explosive or toxic materials. Other uses for the machine will lead to the damage of the machine and a series of dangers to the operator. This appliance is for private and household use, not for professional or industrial ones. Only identical accessories as the ones provided with the tile cutter are authorised. Never use the appliance in the rain or other wet conditions.

1. UNPACKING

The tool is packed complete in one carton. When unpacking and checking the contents of the carton, separate all the parts from the packing material and check each one against the pack contents shown below to make sure that all items are accounted for. If any parts are missing, do not attempt to assemble, or use the tile cutter until the missing parts are obtained and installed correctly. Any missing parts should be reported immediately to the store from which you purchased the tool.

2. ASSEMBLY

INSTALLATION OF THE METAL BRACKET

- Unplug the tile cutter from the mains supply.
- Remove the cover (45° vertical fence) of the water reservoir.
- Remove the two screws and washers from the top of the deck, slide the metal bracket into the desired position (Fig 1) and then fix in place re-using the two screws and washers. Ensure the bracket is perpendicular to the deck and positioned inline with the blade. Loosening these screws allows some minor adjustment to ensure the bracket does not foul the tile when cutting, or if the laser needs slight re-alignment.
- Put the cover (45° vertical fence) back into position.

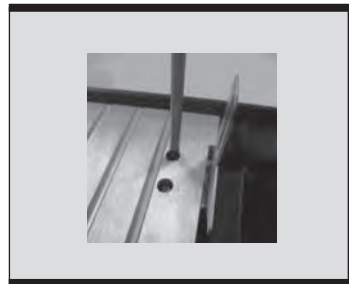

Fig 1

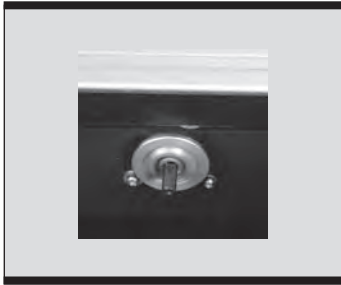

Fig 2

INSTALLATION OF THE DIAMOND DISC

- Unplug the tile cutter from the mains supply.
- Remove the cover (45° vertical fence) of the water tank.
- Insert the inner flange, the diamond disc and the outer flange on the spindle (Fig 2) then tighten the bolt clockwise with the two spanners provided (Fig 3).
- Insert the blade lower guard with the chain into the notches then tighten the screw (Fig 4).
- Put the metal cover back into position.



Fig 3

INSTALLATION OF THE PROTECTIVE GUARD

- Unplug the tile cutter from the mains supply.
- Place the guard onto the metal bracket and fix in place using the screw and washer (Fig 5). Push the cover cap over the nut.
- Cover the diamond disc with the guard.
- Ensure that protective guard can move freely and that it cannot touch the disc.
- Do not over tighten the protective guard when fixing it. The guard should be free to rise and fall as the workpiece is pushed towards the disc.

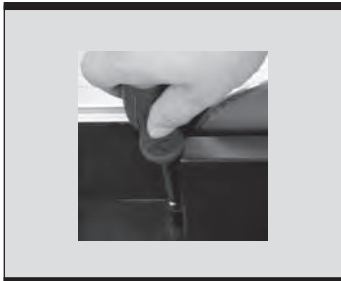

Fig 4

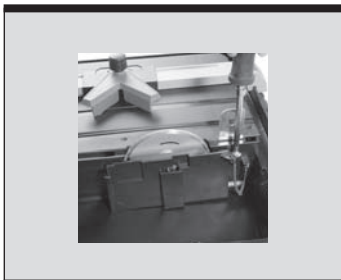

Fig 5

INSTALLATION OF THE PARALLEL GUIDE

- Unplug the tile cutter from the mains supply.
- Insert spring, clamp, washer and knob to the bolt of parallel guide (Fig 6), then tighten the knob to fix this part in parallel (Fig 7).
- Put the parallel guide onto the work table and fix it using the plastic securing knob (Fig 8).
- Mitre cutting can be performed by using the mitre cutting guide. The angle can be adjusted from 0° to 45° by unscrewing the plastic screw (Fig 9).
- To perform 22.5° or 45° bevel cutting, raise one side of the table, lever out the support and locate the tabs into the corresponding holes in the deck (Fig 10). Ensure that the deck is correctly secured before working.

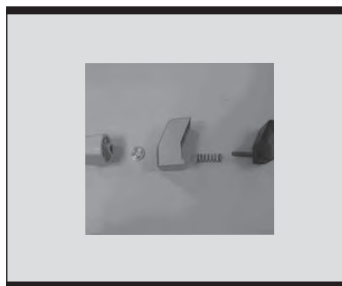

Fig 6



Fig 7



Fig 8

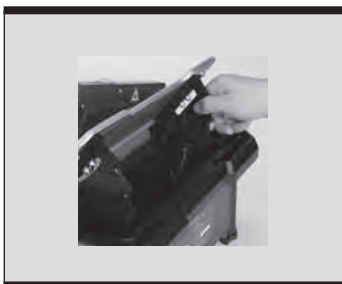

Fig 10

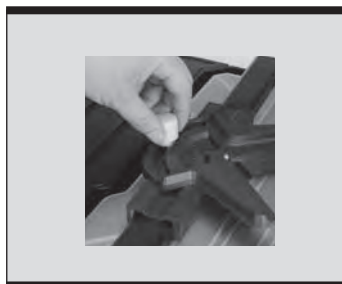

Fig 9



Fig 11



Fig 12

EXTENSION OF THE WORKING TABLE

- Unplug the tile cutter from the mains supply.
- Pull out the table extension to the required length and then secure using the screw shown in (Fig 11).

FILLING THE WATER TANK

Before cutting, the tank must be filled with water:

- Unplug the tile cutter from the mains supply.
- Remove the metal cover from the working table
- Fill the tank with water in order to just cover the disc edge (ensure that no more than $\frac{1}{4}$ of the disc is submerged in water).
- When you have finished cutting, remove the plug inside the tank to drain the water (Fig 12).

WARNING: Do not add chemicals or detergents to the water.

LASER LINE GENERATOR

The laser line generator emits an intense narrow beam of pure red light to guide you as you cut. It improves operator cutting vision, enables faster set up, increase accuracy and improves safety. To fit the 2 LR03 (AAA) 1.5V batteries (not supplied). First remove the lid to battery box. Place the batteries in the box, taking care to note the correct polarity and replace the lid.

To turn on the laser, slide the laser light on/off switch (2) up. To turn off the laser, slide the laser light on/off switch (2) down.

Should the laser line not line-up with the blade cutting path some re-adjustment is possible by slackening the screws holding the guard assembly in place (photo 1).

Ensure the screws are re-tightened after adjustment.

WARNING: Always switch the laser off when it is not being used. We also recommend that you remove the batteries from the compartment when the saw is not used for extended periods.

CONNECTION TO THE ELECTRICAL SUPPLY

Before switching on, make sure that the voltage of the mains supply is the same as indicated on the rating plate. This product is designed to operate on 230-240V~50Hz. Connecting it to any other power source may cause damage.

This appliance must be earthed. If in doubt, please

consult a qualified electrician.

The mains supply shall be fed via a 10A fuse min.
This machine must be supplied through a residual current device (RCD).

3. OPERATION

Put the tile cutter on a clean, stable and flat surface.

 **WARNING!** Before switching the tile cutter on, make sure that you have read and understood all of the safety instructions. Make sure also that the machine has been correctly assembled and adjusted. Make sure that the mains is disconnected from the supply when the tile cutter is not being used or adjustments are being made.

 **WARNING!** This machine must be supplied through a residual current device (RCD).

- Plug the mains cable into the mains supply.
- Press the green switch marked I.
- The machine will now start. Always allow the disc to reach full speed before performing any cutting operations.
- To switch off the machine, push the red switch marked 0. The tile cutter will now stop.

 **WARNING!** The disc will continue to rotate for a few seconds after the machine has been switched off. Wait for the disc to stop before removing the workpiece or making any adjustments.

Stop the machine immediately if there is undue vibration or some other fault. If this situation continues, check the machine to find the origin of the fault.

MAKING A STRAIGHT CUT

Adjust the parallel guide to the desired width. Use the securing knob to loosen or adjust the guide. Position the tile firmly against the parallel guide and through the blade in a smooth action. Hold the edges of the tile and press down firmly to prevent the tile lifting during the cut.

MAKING A MITRE OR DIAGONAL CUT

Follow the same procedure for a straight cut but use the mitre cutting guide in conjunction with the parallel guide.

The mitre cutting guide simply clips onto the parallel guide.

Make sure that the tile is held firmly in the guide before making the cut.

CUTTING AN ANGLE OR BEVEL

Use the 45° vertical fence if you wish to cut an angle or bevel on the tile edge. lift the 45° vertical fence inserting the plastic tabs into the corresponding holes on the table. Then make the cut as before.

Internal or external bevel cuts can be made by turning the tile face up or down (internal - eg.wall corner; external - eg. window reveal).

MAINTENANCE

Ensure that appliance is disconnected from supply before installation, before cleaning and maintenance operations.

Apart from diamond discs there are no other user serviceable parts inside this tile cutter. Refer to qualified service personnel if internal maintenance is required. Any worn, or damaged parts should be replaced immediately by qualified personnel. Keep discs in good condition. Poor condition or worn discs can increase the noise level emitted. Do not allow dust to accumulate inside, or on the product. After use, clean all excess dust from the table and the area around the table. Frequently clean the machine using a soft brush or vacuum cleaner.

If the supply cable is damaged, it should be replaced by the same type of cable as the one provided and recommended by the manufacturer (H05 VV-F 3G0.75 mm²). The supply cord of the tool and any extension cord used should be checked frequently for damage. If damaged, have the cordset replaced by an authorised service facility. Replace the extension cord if necessary.

PLUG REPLACEMENT

If you need to replace the fitted plug then follow the instructions below.

IMPORTANT: The wires in the mains lead are coloured in accordance with the following code:

Blue – Neutral

Brown – Live

Green/Yellow – Earth

As the colours of the wires in the mains lead of this appliance may not correspond with the coloured markings identifying the terminals in

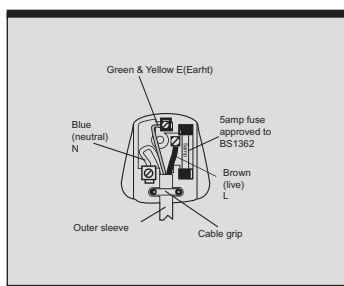



Fig 13

your plug, proceed as follows. The wire, which is coloured blue, must be connected to the terminal which is marked with an N or coloured black. The wire, which is coloured brown, must be connected to the terminal which is marked with an L or coloured red. The wire, which is coloured green/yellow, must be connected to the remaining terminal which is marked with an E or 

WARNING: Never connect live or neutral wires to the earth terminal of the plug. Only fit an approved 3 Amp BS1363/A plug and the correct rated fuse.

NOTE: If a moulded plug is fitted and has to be removed take great care in disposing of the plug and severed cable, it must be destroyed to prevent engaging into a socket.

ENVIRONMENTAL PROTECTION



Waste electrical products should not be disposed of with household waste.

■ Please recycle where facilities exist.

Check with your Local Authority or retailer for recycling advice. For further information visit www.recyclemore.co.uk

Erbauer®

Declaration of Conformity

We, Importer
Erbauer (UK) LTD BA22 8RT

Declare that the product
**ERBAUER 750W TILE CUTTER
ERB337TCB**

Complies with the following Directives:

Machine Directive **2006/42/EC**
and/or Low voltage directive **2006/95/EC**
EMC directive **2004/108/EC**

2002/95/EC Restrictions of the Use of Certain Hazardous Substances in
Electrical and Electronic Equipment

2002/96/EC and **2003/108/EC** Waste Electrical and Electronic
Equipment (WEEE)

Standards and technical specifications referred to:

EN61029-1(2009)
EN 55014-1(2006)
EN 55014-2(1997)+A1(2001)+A2(2008)
EN 61000-3-2(2006)
EN61000-3-3(2008)

Authorised Signatory and technical file holder

Date: 14/06/10

Signature: P.C. Harries

Name: Peter Harries

Erbauer (UK) Ltd
Quality Manager



2010

Erbauer®

ERBAUER 750W TILE CUTTER