

29/11/2010

# Instruction pack

R7a

# Caledonian

## 4190x4190(14x14)

28mm log

**NO OTHER PARTS REQUIRED**

**CHECK ALL PARTS BEFORE ASSEMBLY OR  
EMPLOYING TRADESPEOPLE**



LOG SHEET

Building: **Caledonian**  
 Building Size: **4190x4190(14x14)**  
 Date: **08-Nov-10**

LOG 28mm |MM

**ID no** see packing sheet



Log	Length	Quantity
A	4190	48
A1	4190	2
A2	4190	1
C	1352	16
C1	1352	2
D	390	16
E	262	16
G	4315	2
H	4440	2
I	4565	2
J	4690	2
	0	0
	0	0
	0	0
	0	0
	0	0
	0	0
	0	0
	0	0
	0	0
	0	0
	0	0
	0	0
	0	0
	0	0
	0	0
	0	0
	0	0
	0	0
	0	0
	0	0
	0	0
	0	0
	0	0
	0	0
	0	0
	0	0
	0	0
	0	0
	0	0
	0	0
	0	0

SPARE LOGS	
A	0 2
C	0 2
D	0 1

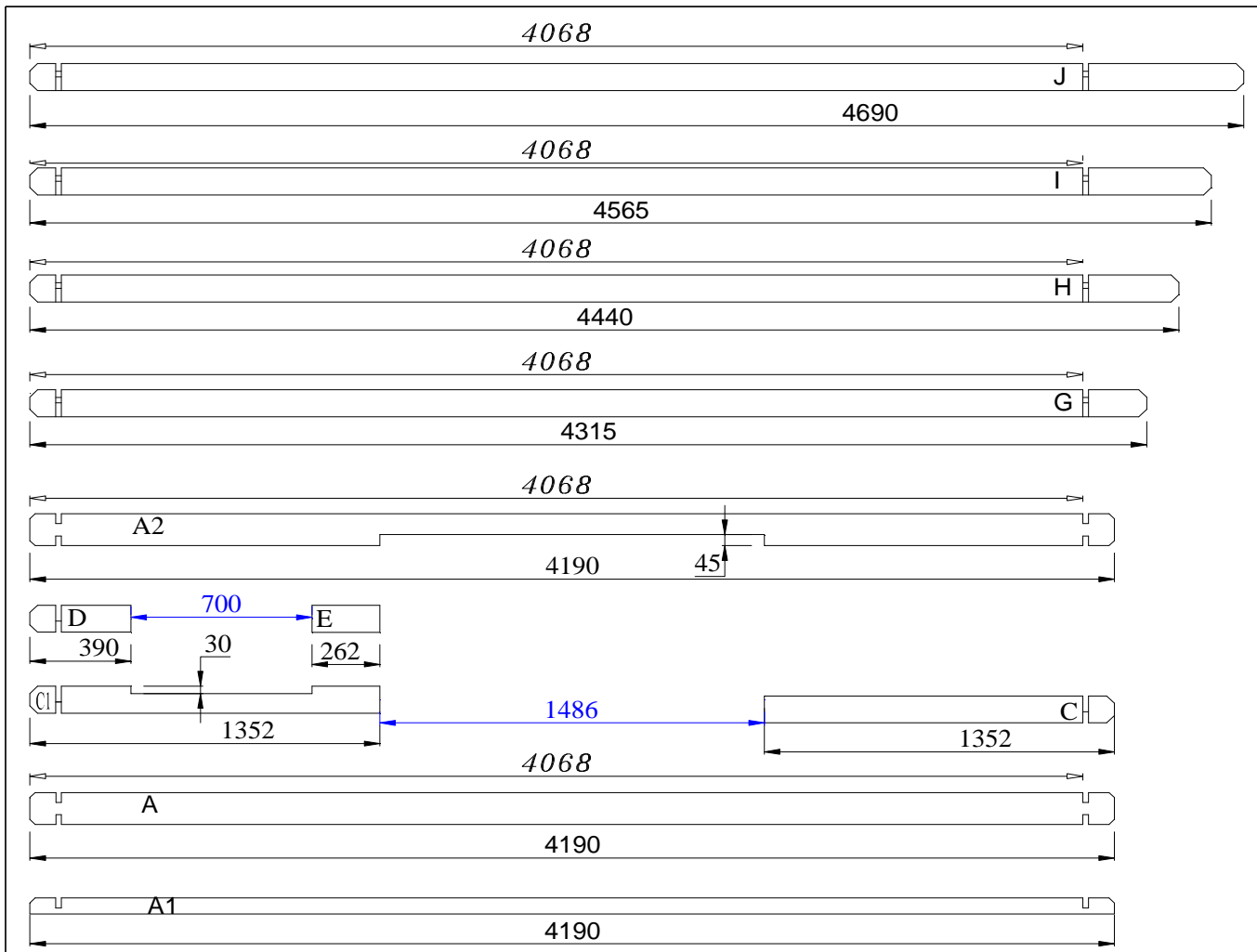

**120X40 JOISTS**

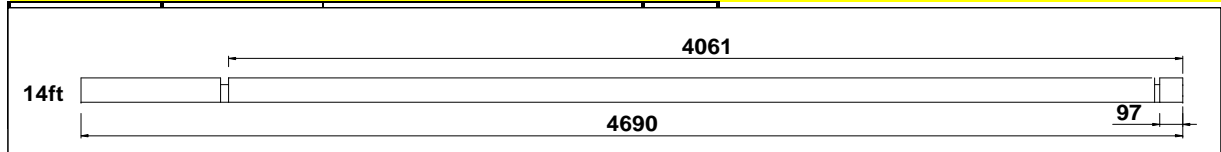



# SHIRE

BUILT AROUND OUR REPUTATION

## 34/44/70 DOUBLE DOOR -INNER FRAME ASSEMBLY

SCREW  
HERE  
T

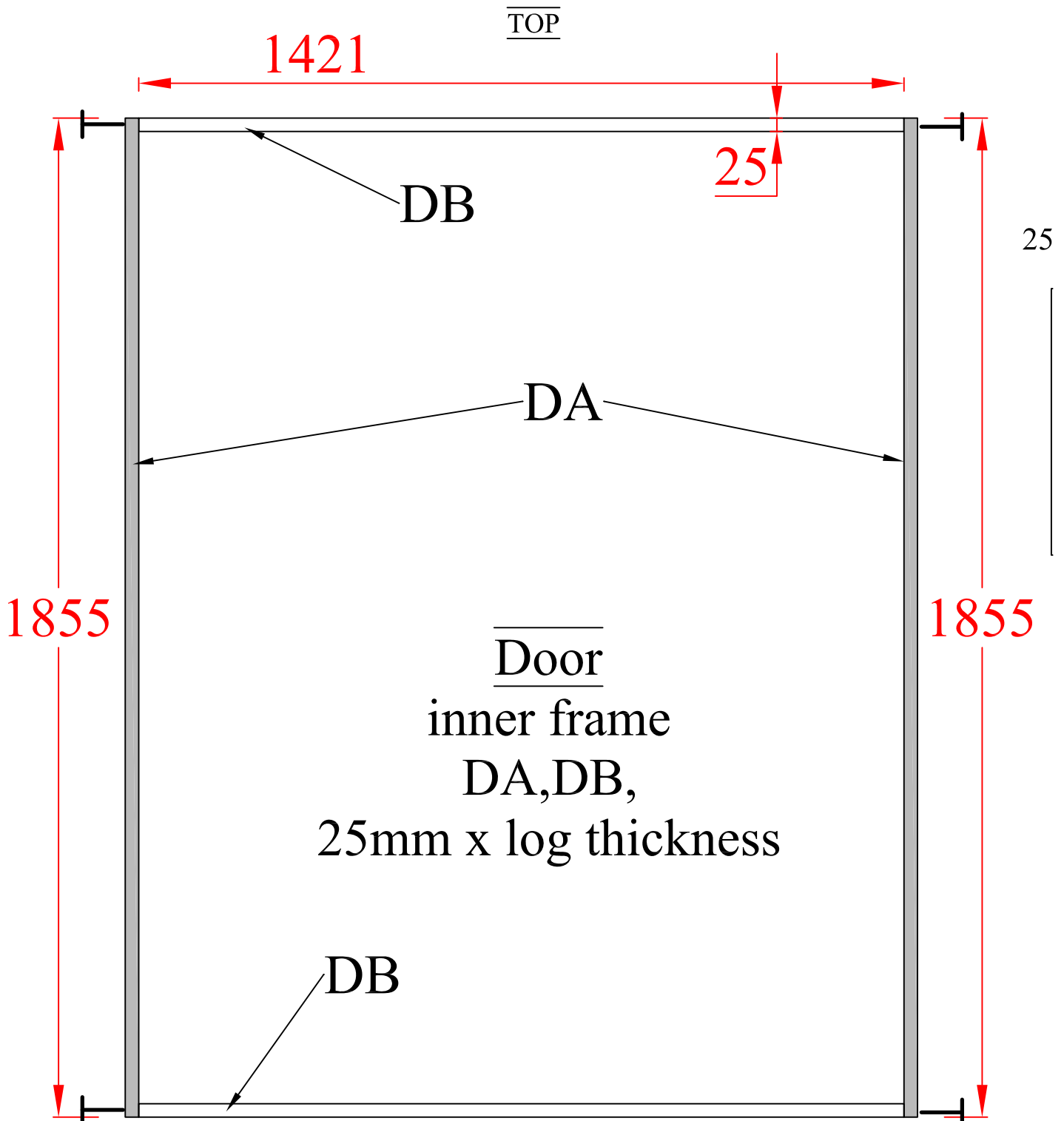

1777-2		1421-2	rubber
1600			drip bar

## 34/44/70 DOUBLE DOOR OUTER FRAME ASSEMBLY

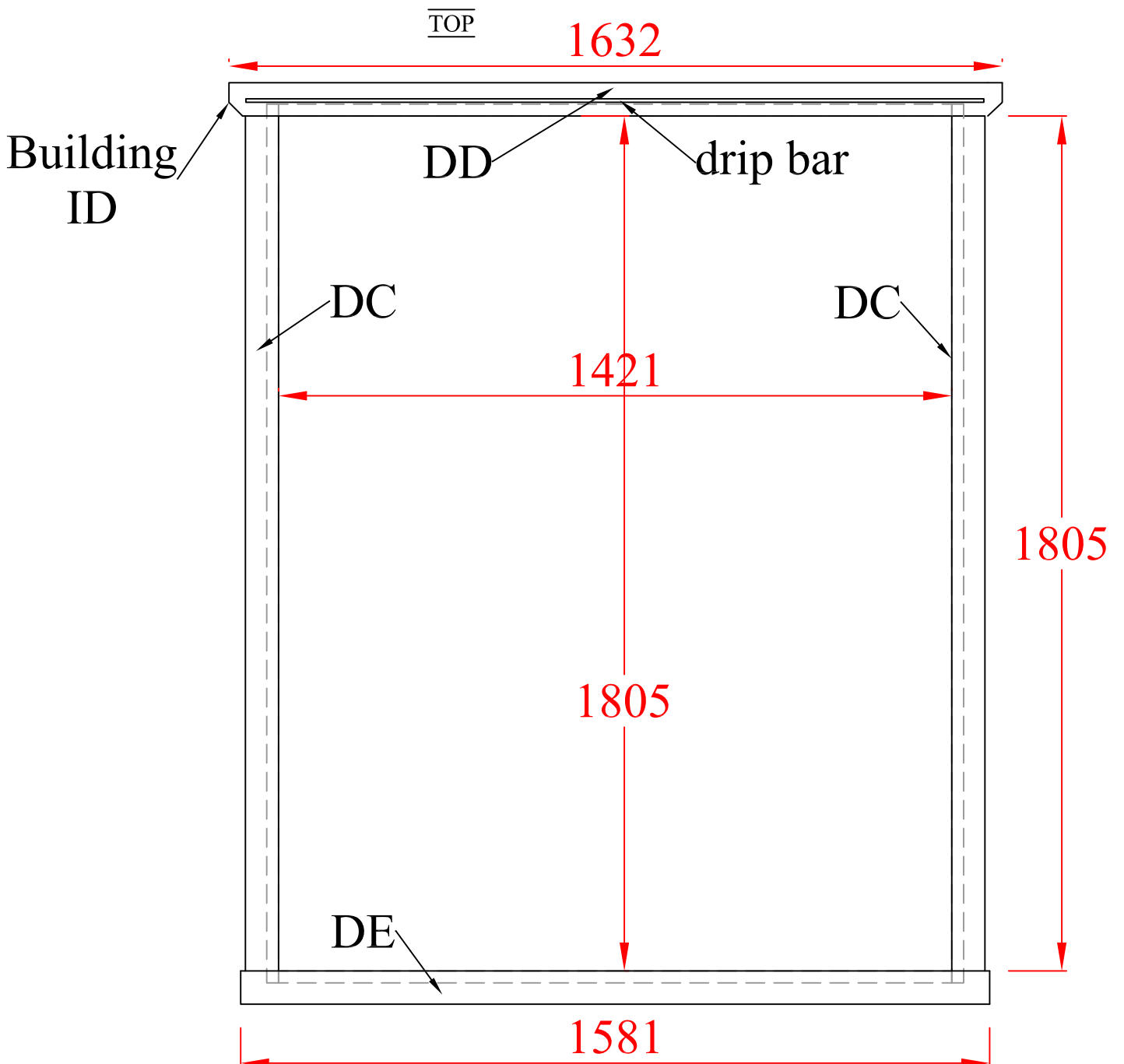

W4-S  
WINDOW

-INNER FRAME ASSEMBLY

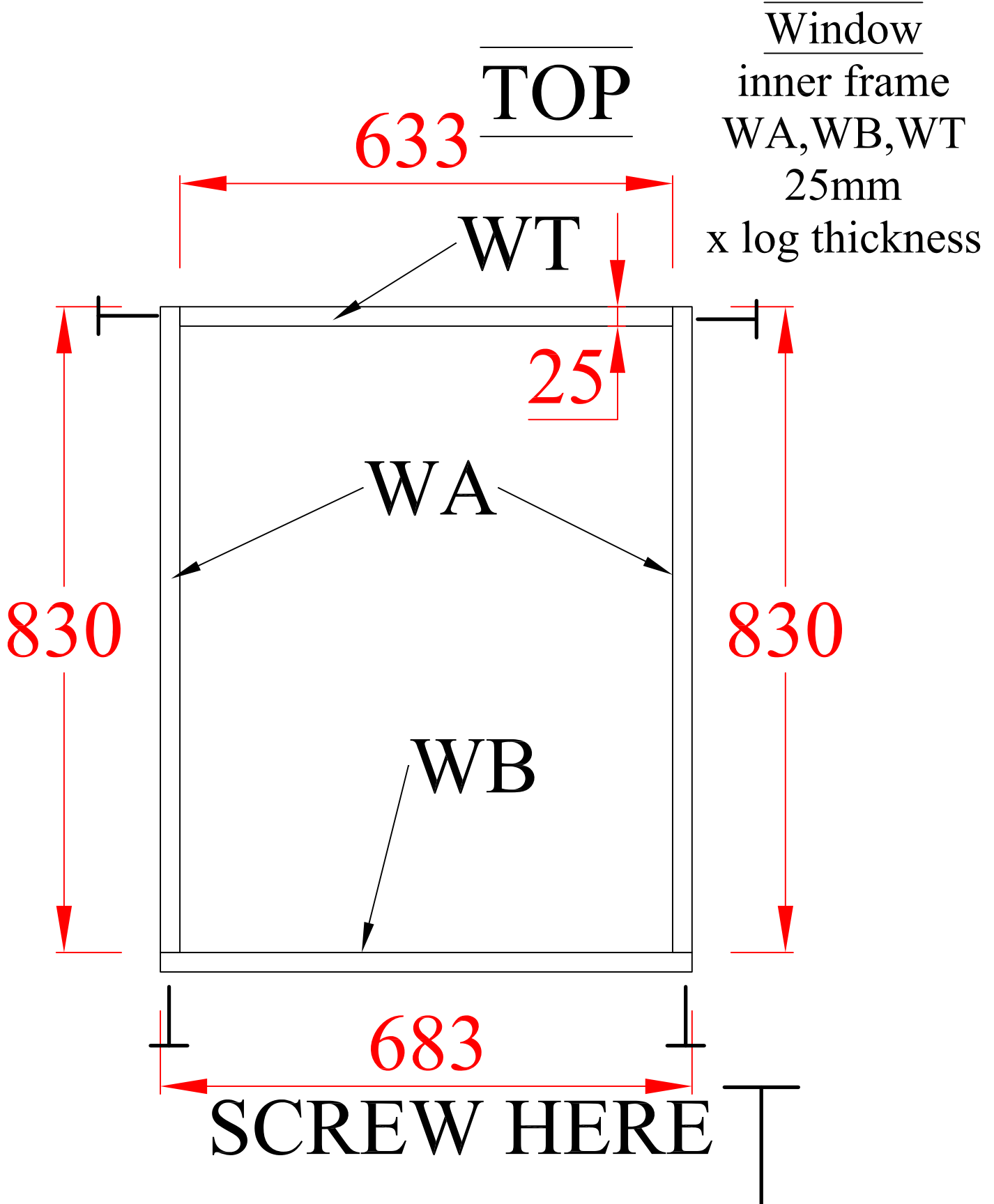

# SHIRE

BUILT AROUND OUR REPUTATION

633-2	776-2	rubber
800		drip bar

## W4-S WINDOW- OUTER FRAME ASSEMBLY

### TOP

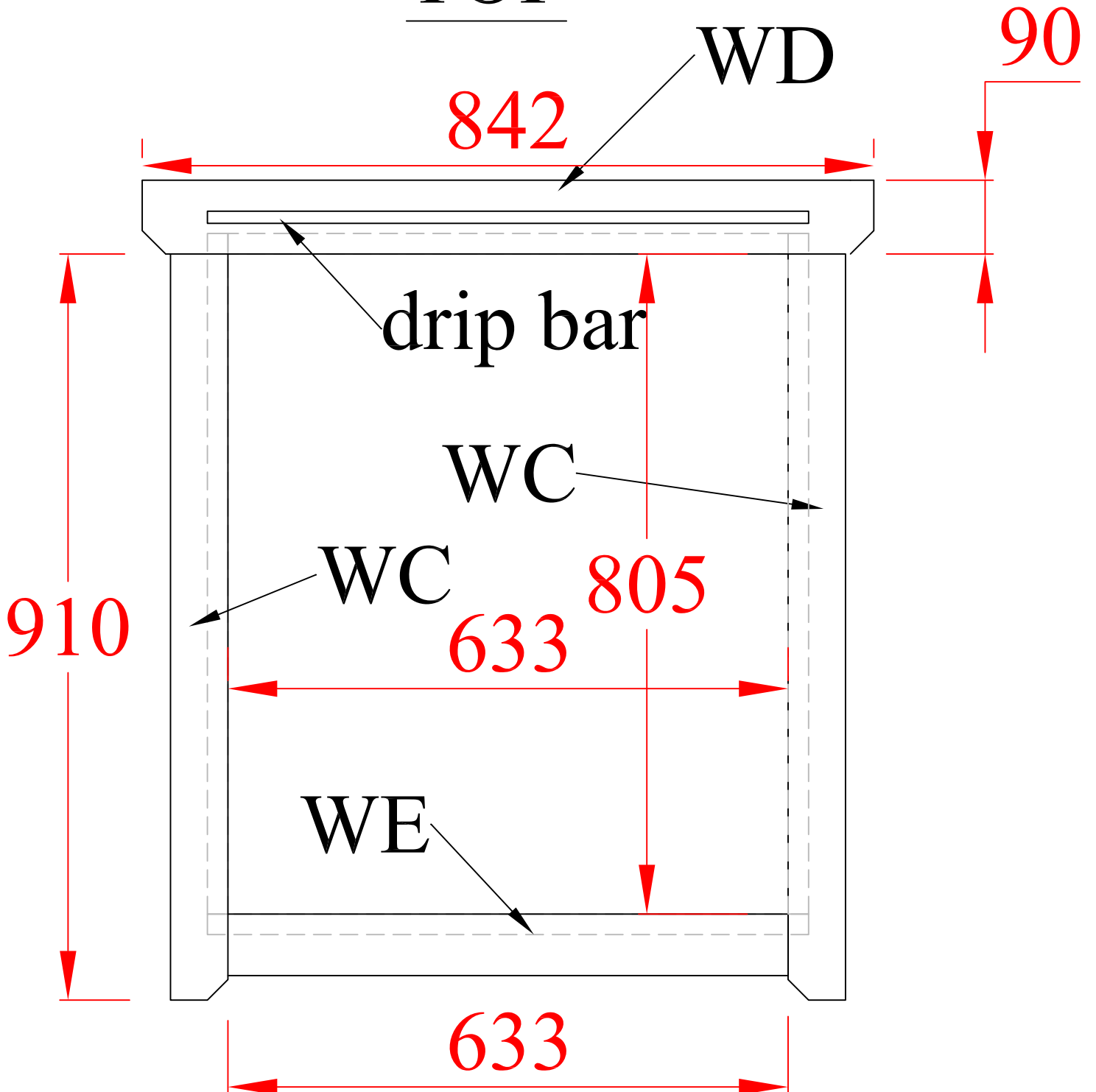



# SHIRE

BUILT AROUND OUR REPUTATION

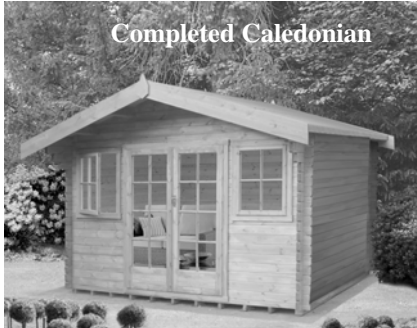

Completed Caledonian

## Tools required

- . Hammer
- . Rubber mallet
- . Spirit level
- . Stepladder
- . Battery-powered drill/screwdriver
- . 8mm drill
- . 3mm drill
- . Tape measure
- . Gloves
- . Sharp knife and saw
- . string
- . Oil for lock

## IMPORTANT!

1. **Check all components before commencing with the construction of your Caledonian**
2. **Keep all timber dry or your building will not fit together.**
3. **We also recommend that you seal the corner log joints with silicone sealant (not supplied).**
4. **We recommend a minimum of two people required for assembly.**
5. **Read through all the instructions before constructing your pine lodge.**
6. **You will see there is a set of lettered drawings showing each side of the building. You will find these letters printed at one end of each log or in the slot.**

## PLEASE NOTE

Wood is a natural product and is therefore prone to changes in appearance, including some warping, movement and splitting, particularly during unusual climatic conditions (long hot or wet spells of weather). As a natural occurrence this is not covered by a guarantee.

## Assembly of Caledonian 4190x4190 (14x14) ©

Thank you and congratulations on the purchase of your Shire pine lodge. We believe that this product will give you many years of excellent service. This is a natural product manufactured to a high standard therefore if you have any queries or experience any difficulties then please contact our customer service hotline on **01945 46 89 10 01945 46 89 11 01945 46 89 12**

Normal office hours: 8.30am to 5.00pm Monday to Friday. Answer phone all other times.

## Preparation of base

The base onto which you build your Cabin needs to be flat and level. We only recommend you use concrete that is a minimum of 10 cm thick  
**Base size at least 3996mm x 3996mm**  
 Please refer to section D and drawing pages 1 & 2 .  
 Please note that the corner joints protrude over the edge of the base.

## Treatment/care of your pine lodge

All timber must be dry to apply the timber treatment. Treat with a suitable decorative wood finish immediately. We recommend that you treat the door, window glazing rebates and beading with a top quality timber treatment before assembly and treat the entire building as soon as assembly is complete, we further recommend that all pieces are treated and again within 3 months of assembly and again at least annually or as frequently as the instructions on the product used recommends.

**Note** the back of the door and window units unscrew so they can be removed for painting We would also remind you that you would rarely (if ever) be able to re-treat the underside of the floor boards following assembly.

We strongly recommend that the underside of the floor is treated an absolute minimum of twice. The floor bearers are pressure treated and don't need to be treated although you may if you wish. We also recommend that you seal the external corner joints (fig D4) with silicone sealant (not supplied) **LUBRICATE LOCK It is extremely important that you lubricate your lock through the key hole and all moving parts as soon as possible after assembly and at least at monthly intervals thereafter . Also ensure that you regularly operate the lock especially during the winter or when not in use.**

## Parts list

See drawings for log quantities.

PLEASE LAY OUT PARTS AND CHECK OFF AGAINST CHECK LIST BELOW:

These details may be repeated in the drawing sheets.

BUILDING ASSEMBLY PARTS		QTY	DESCRIPTION-	CODE
<b>FLOOR-</b>	<b>QTY DESCRIPTION- sizes in mm unless stated</b>	<b>W4</b>	<b>WINDOW FRAME KIT -TAPED TOGETHER-</b>	<b>IN SETS- 2 SETS REQ- QTY PER SET</b>
12	Pressure treated floor bearers 3996	2	Window frame 25x28x830	<b>WA</b>
30	Floor boards 139x16x3942	1	Window frame 25x28x683	<b>WB</b>
3	Skirting 25x40x4000	1	Window frame 25x28x633	<b>WT</b>
2	Skirting 25x40x1300	4	Architrave 70x20x910	<b>WC</b>
<b>ROOF-</b>		2	Architrave 70x20x842	<b>WD</b>
*	<i>Note the Angled eaves edging, Eaves fascia &amp; roof edging may be supplied in shorter lengths.</i>	2	Architrave 70x20x633	<b>WE</b>
3	Rolls felt 10m	1	Drip bar 800	
1	Roll felt 6m	2	Draught excluders 25x40x776	<b>W4-DL</b>
4	Fascia boards 143X22x2350	2	Draught excluders 25x40x633	<b>W4-DS</b>
2	Diamond	2	Window insert	<b>W4-I</b>
2	Angled eaves edging 44x24x 4690*	2	Casement stays with 2 pins and screw sets	
2	Roof edging 60x4x 46090*	2	Set Brass leaver night vent fasteners	
68	Roof boards 139x16x2300	22	Glazing- toughened 268x352	
7	Roof bearers 44x70 x4690	44	Short Beading	
<b>DOORS &amp; WINDOWS-</b>	<b>CODE</b>	44	Long Beading	
1pair	External doors	<b>DD1</b>	<b>HARDWARE-</b>	
<b>DOOR FRAME KIT -TAPED TOGETHER-</b>		10	100mm door & window hinges	
2	Door frame 25x28x1855	85	25mm screws	
2	Door frame 25x28x1421	152	40mm screws	
4	Architrave 70x20x1805	110	50mm screws	
2	Architrave 70x20x1632	40	80mm screws	
2	Architrave 70x20x1584	195	Panel pins	
2	Draught excluders -door 25x40x1777	415	Felt nails	
2	Draught excluders -door 25x40x1421	75	25mm oval head nails	
1	Drip bar 1500	745	40mm round head nails	
1 set	Brass leaver handle set for doors	690	40mm oval head nails	
2	Door keys-taped to glazing bars	14	70mm nails	
2	Sets cranked door bolts			

## IMPORTANT!

The only parts that require cutting are the angled eaves edgings , final roof and floor boards and the skirting.

**DO NOT CUT ANYTHING ELSE**

**IMPORTANT SAFETY INFORMATION**

- We recommend the wearing of non-slip protective gloves throughout the assembly process. We also recommend the wearing of steel capped protective shoes, protective head gear, safety glasses and full length clothing. If step ladders are to be used we recommend one person holds the ladder whilst the other is using them. If necessary a third person should be used. Do not attempt to erect the building in windy conditions. Follow any safety precautions quoted by the manufacturer for any equipment you use.
- Every precaution has been taken to ensure that your building has no element incorrectly placed or possibly hazardous. However prior to use please check for raised grain or splinters and sand if necessary. Check that all elements are secure against reasonable force.

**A Window Frame**

1. Refer to the window drawing page and to letter codes in contents table. The **WT** and **WD** parts will be at the top of the window frame.
2. To be sure you can lay all the pieces, including inserts together without fixing to familiarise yourself with the assembly.
3. Make sure the window insert fits inside the frame with a 5mm gap all around.
4. Lay out the parts **WA** and **WB** and **WT** as in the inner frame assembly drawing. The narrowest (25mm) edge to the work bench and the side the size is the same as the log thickness as shown in fig A1 . Part **WT** must be inside parts **WA** and part **WB** underneath the two **WA** parts (Fig A1) .
5. Pre drill 2 3mm holes at one end of the **WA** only and at both ends of the **WB** parts ( see drawing )and screw together at each corner,10mm in from the edge (ensuring each corner is flush) with 2x50mm screw (fig A1).

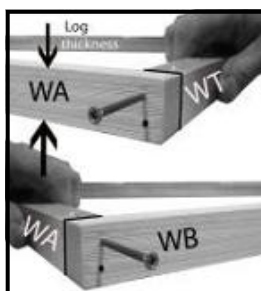

Fig A1

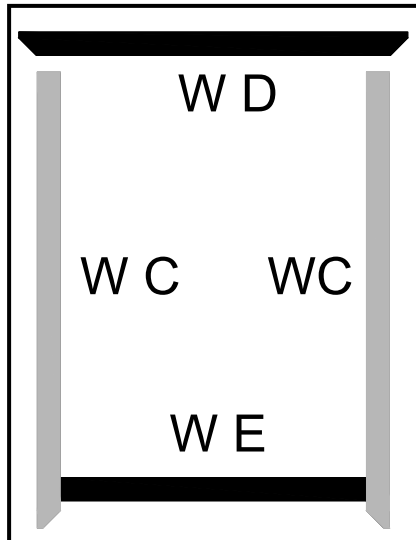

Fig A2

7. Layout parts **WC** ,**WD** & **WE** as in fig A2 & drawing on top of the frame from steps 1-6 flush with the inner edge of the frame .



Fig A3

8. Mark the first hole position 30mm from the end of part **WC** that is next to part **WD** , at the other end mark the hole central to the **WB** underneath and then the rest at approximately 260mm centres between these holes.
9. Note the **WC** ,**WD** & **WE** pieces fitted to the opposite side must be drilled off-set to this side to ensure the screws miss each other.
10. Place the other **WC** part underneath and drill through both pieces with a 3mm drill (fig A3).

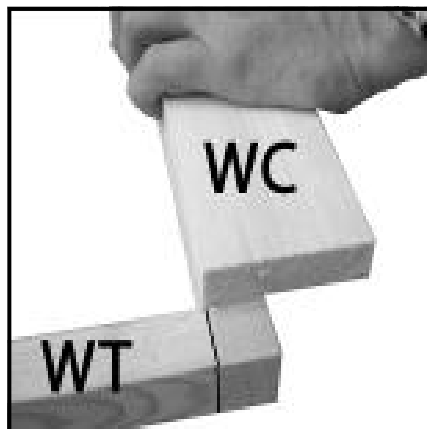

Fig A4

11. Place one of the **WC** parts on top of the **WA** parts level with the inside of the frame and the bottom of the **WT** part (fig A4).
12. Fix to part **WC** to **WA** with 40mm screws (fig A5 & A6)
13. **important** fix at both ends first ensuring that they stay flush then the screws in between again ensuring that parts **WA** & **WC** are flush as you go.

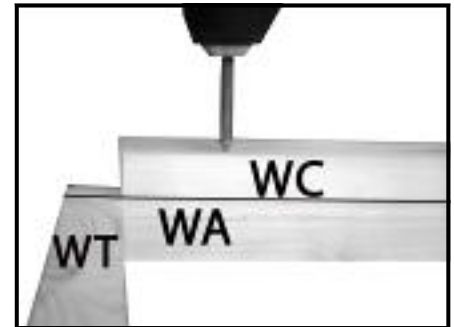

Fig A5

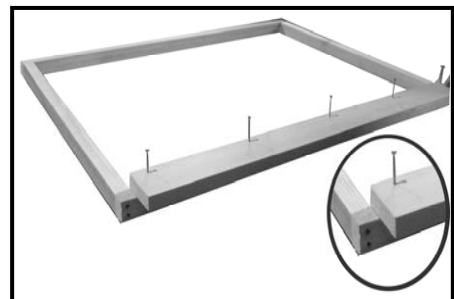

Fig A6

14. Place a **WD** part on top of a **WB** part. The **WD** part is positioned so there is an even overhang (fig A7). Mark out and drill fix as steps 8 to 10. But start at 100mm from the end of part **WD**.



Fig A7

15. Drill (not too deep) and screw in each corner with 40mm screws (fig A8).



Fig A8

16. With a pencil mark the screw centres on the inside long edge of the frame to help ensure the hinge screws will miss these screws.
17. Turn frame over and repeat steps 4 to 12 on the other side (fig A9 & A10).
18. **Note offset drilled holes from first side to ensure they miss each other** first hole part **WC** =30mm part **WD** =100mm



Fig A9

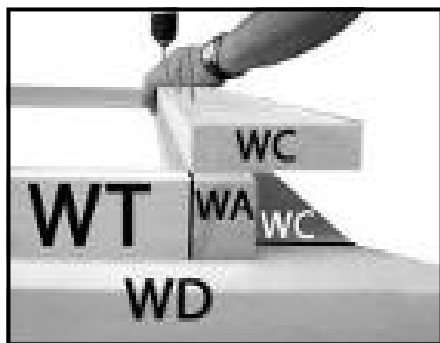

Fig A10

20. **Window insert.** Place one hinge on the inner rebate part of the window; approx. One hinge width along from the rebate edge **on the top side**. The rounded part of the hinge should sit above the outer edge of the window. Screw the inner piece into position
21. ( fig. A11 & A12) using the pre drilled holes in the hinge and 3 x 25mm screws. Repeat with the other hinge. And close the hinges together.

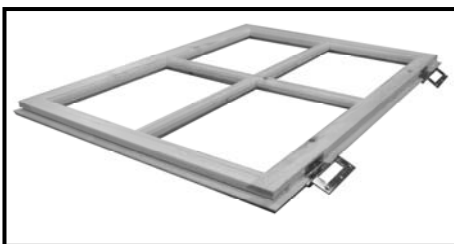

Fig A11- STYLE MAY VARY



Fig A12

22. Place the window into the aperture (fig A13 ) **ensure that part WD** ( FIG A13) is against the hinges (TOP HUNG )**or** against the **WC** (side hung ) .
23. Secure the window to the panel using 3x 25mm screws per hinge, (fig. A14 ) again through the predrilled holes in the hinge.
24. Repeat.

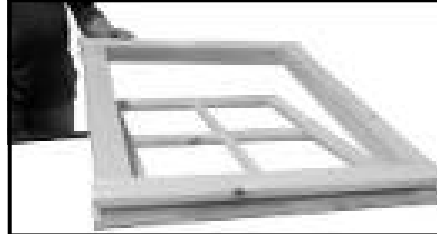

Fig A13

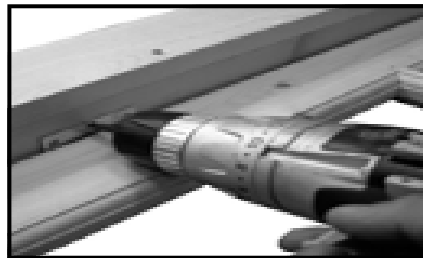

Fig A14

25. Open the window fully in order to fit a further 2x 25mm screws per hinge ( Fig. A15).

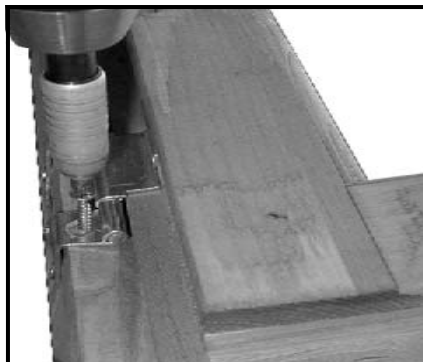

Fig A15

26. **Fitting the draught excluder. This must be done before fitting the casement stays and latches.**



Fig A16

27. Lay the assembled window unit with the opening insert downwards onto your work surface (Fig A16).
28. Position the draught strips so the rubber is against the opening insert and fix with 4x25mm oval nails per strip (Fig A16).

29. **Fitting the Casement Stays.** Place the casement stay evenly on the inside of the window (Fig A17 ) on top of the draught excluder.
30. Place the 2 pins under each casement stay. Position so that it is not resting on the window frame and not so high that the pins are of no use.



Fig A17

31. Fit the Casement Stay (fig A18) on the window using 2x 25mm screws.

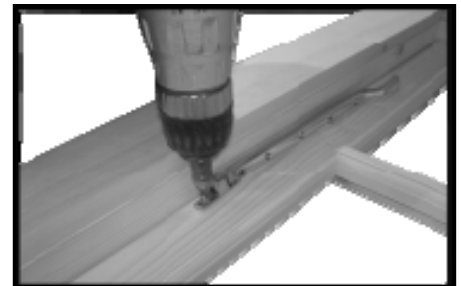

Fig A18

32. Mark where the 'pins' will be placed.

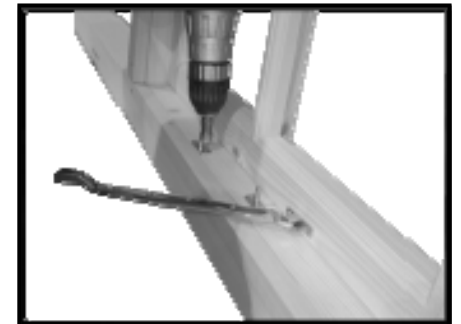

Fig A19

33. Secure into position using 4x 25mm screws - 2 in each pin.

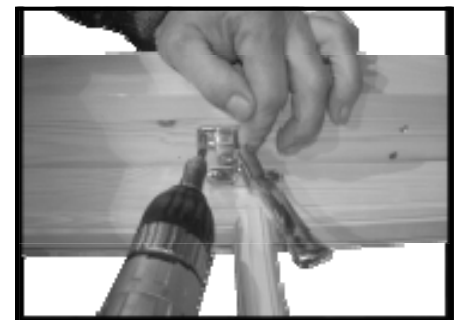

Fig A20

34. **Latch** Along side one of the horizontal bars in the window insert place the side latch on top of the draught excluder. (fig A20)
35. Use the pin to correctly place the lever and secure using 2x25mm screws for each part (Fig A20).
37. **Drip bar.** Turn the window unit over so the opening insert is uppermost .



Fig A21

38. Position the drip bar he drip bar by measuring 45mm down from the top of the **WD** part above the hinges and fix the drip bar with 3x25mm screws. Repeat with the other window unit
39. Put the completed units to one side until required .
40. **Note** do not glaze until all parts have been treated and the units fitted in the building

### B Double door assembly

1. Refer to letter codes in the table on the front page.
2. Lay out the parts **DA** and **DB** as in fig B1 and **see drawings**
3. The 25mm edge to your work surface , Parts **DB** must be inside parts **DA**.
4. Screw together at each corner, 10mm in from the edge (ensuring each corner is flush) with 2x50mm screws (fig B2).

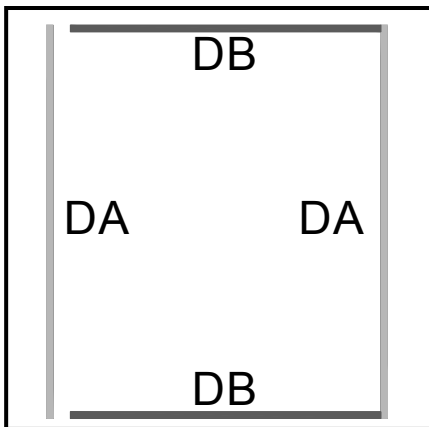

Fig B1

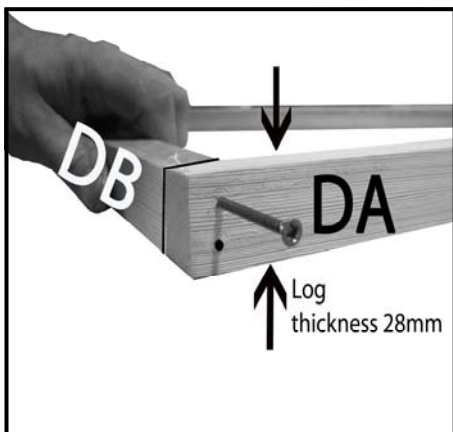

Fig B2

5. **REF.** This frame is set out similar to the pre-constructed window frame.

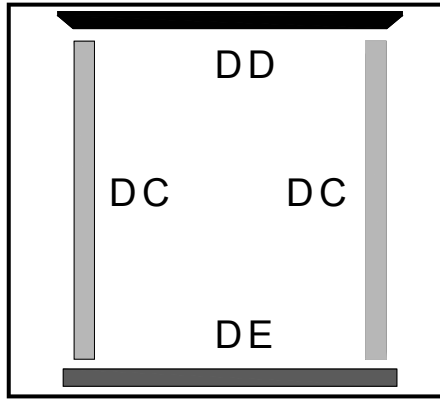

Fig B3

6. Layout parts **DC**, **DD** & **DE** as in fig B3.
7. Mark the first hole position 30mm from each end of part **DC** and then the rest at approximately 200mm centres.
8. Note the **DC**, **DD** & **DE** pieces fitted to the opposite side must be drilled offset to this side to ensure the screws miss each other.

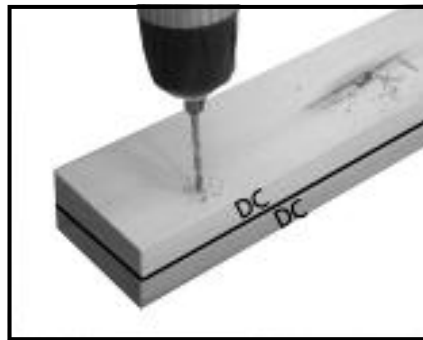

Fig B4

9. Place the other **DC** part underneath and drill through both pieces with a 3mm drill (fig B4)



Fig B5

10. Place one of the **DC** parts on top of the **DA** parts level with the inside of the frame (fig B5)

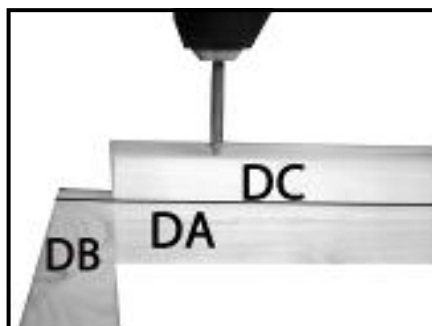

Fig B6

11. Fix to part **DC** to **DA** with 40mm screws (fig B6 &B7) important fix at both ends first ensuring that they stay flush then the screws in between again ensuring that parts **DA** &**DC** are flush as you go.

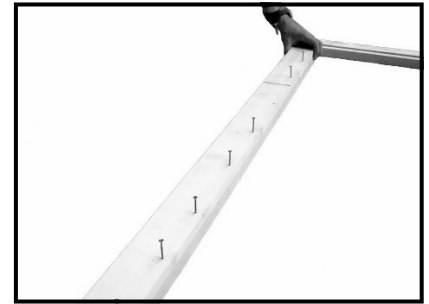

Fig B7

12. Place the **DD** part on top of a **DB** part. The **DD** part is positioned so there is an even overhang (figB8). Mark out and drill fix as before. But start at 100mm from the end of part **DD**.



Fig B8

13. Drill (not too deep) and screw in each corner with 40mm screws (fig B9).



Fig B9

14. With a pencil mark the screw centres on the inside long edge of the frame to help ensure the door hinge screws will miss these screws.
15. Turn frame over and repeat steps 9 to 14 on the other side (fig B10&B11).
16. **Note** offset drilled holes from first side to ensure they miss each other first hole part **DC**=40mm part **DD** 110mm part **DC**=40mm part **DD** =110mm

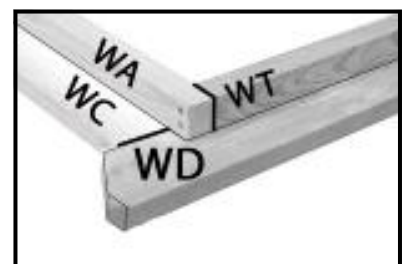

Fig B10

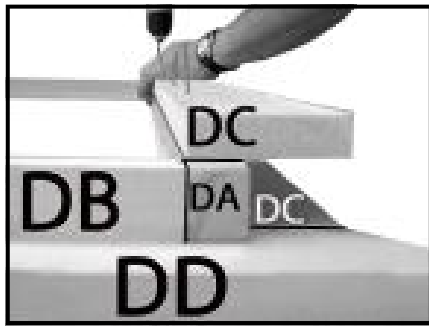

Fig B11

**C Doors**

1. Lay doors on the floor, as you would view them from the inside of the building. Make sure the door with the lock is situated on the left when viewed from the bottom.
2. Lay the outer frame in position (fig C1).
3. The hinges are fitted on the longest outside edge of the doors.
4. Make a visual judgement to the gap top and bottom of the doors then transfer the screw centre marks (see step B 14) to the doors. This is to ensure the hinge screws miss the frame screws.
5. Lift off the outer frame making note of which way around you have put it.
6. Place the hinges as shown in fig C1. Screw the inner piece of the hinge to the door with 3 x 25mm screws.

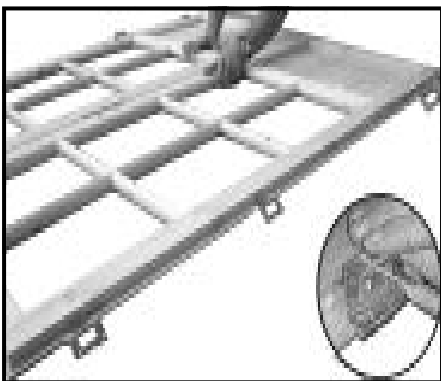

Fig C1

7. Close the hinges and lay the frame assembly over the doors (fig C2).



Fig C2

8. Make a visual judgement to set an even gap top/bottom of the doors and secure each hinge with 1x25mm screws (fig C3). Ensure the hinges are tight against the face of the doorframe.

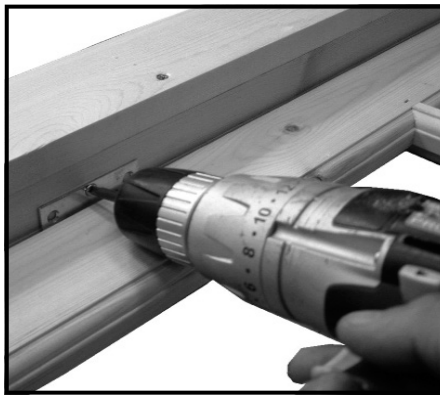

Fig C3

9. Stand the assembly up. Note two people needed for this step. Open the doors and secure hinges with remaining 4x25mm screws per hinge
10. **Fitting the draught excluder. This must be done before fitting the door bolts.**
11. Lay the assembled unit with the doors downwards onto your work surface (see Fig A17 window assembly).
12. Position the draught strips so the rubber is against the opening insert and fix with 3x25mm oval nails per strip (Fig A17 window assembly).



Fig C4

13. Fit two bolts on the door without the lock (fig C4). The top bolt should be positioned just below the draught excluder. Fix with 4x10mm screws.
14. Extend the bolt to meet the frame and mark then drill an 8mm hole (not through the frame) to take the bolt.
15. Put the door assembly to one side until required.

**D Floor bearers & first logs**

**See drawing pages 1&2**

Read the Following the instructions below fully and study the drawing pages before you assemble your building up to and including the gables



Fig D1

1. Take four bearers and place them in pairs with the longest faces together and nail at an angle with 4 70mm nails each. These are for the outer bearers.
2. Take the half height log (A1) that sit on the bearers so that you see the bearer ends and mark the floor bearer centres, but not the outer bearers, from one end (fig D1 & drawing pages

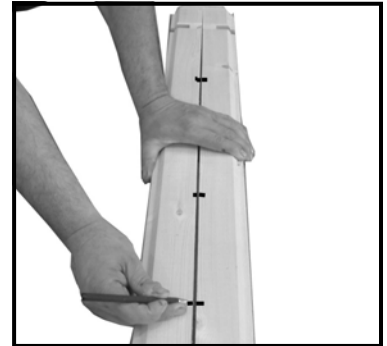

Fig D2

3. Place the 'A1' logs against each other and transfer all the lines across (fig D2).
4. The bearers stand with the narrowest edge to the floor (fig D3) and their ends level with the A1 logs face. Do not fix until step 11.



Fig D3

5. Assemble the first row of logs on top of the bearers by placing the half height (A1) logs in position and then the first of the logs (A) from each wall that run parallel to the bearers on top of them. (See drawing page 1 and section E4). DO NOT FIX YET.
6. **The logs are assembled with the tongues upwards**
7. Position the outer bearers so the outer log sits 5mm in from the outer face (fig D3 & D4) of the side log and level with the front and back logs.



Fig D4

8. Cut notches out of the tongues on the **A1** logs ( fig D5 & D6 ) at centre marks (previous steps ) and drill through for fixing to the bearers .
- 9. Important**
10. Measure corner to corner, as building must be square
11. Also measure length at the centre of the building from wall to wall (**A1 to A1**) to ensure correct length before fixing to joists with 1x 80mm screw (fig D5 & D5) at each bearer .

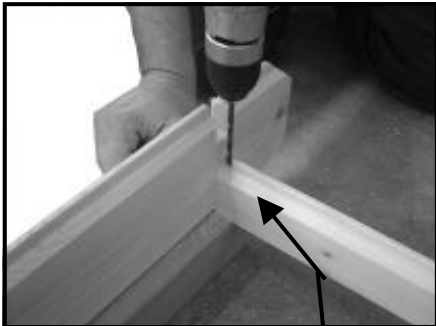

Fig D5

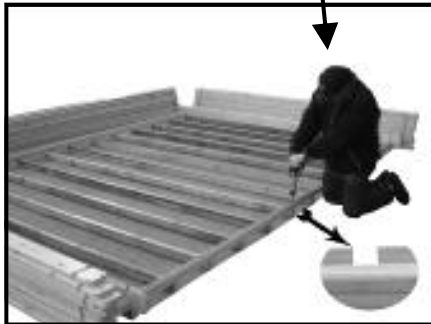

Fig D6

12. This is the bottom of all four walls now ready to be built upon.

### E Walls

#### See drawing pages

1. Using parts list for each wall layout correct quantity (fig E1) of each component for relevant wall (i.e. front, back) in suitable position for ease of assembly.

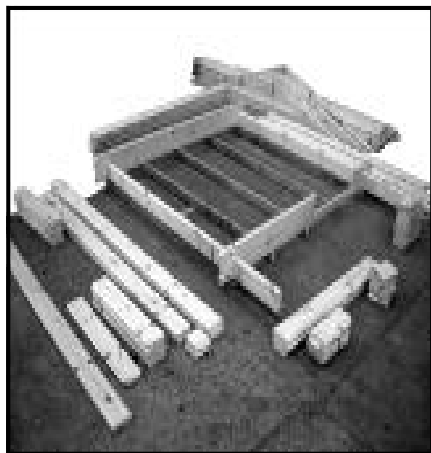

Fig E1-example

2. The walls can now be assembled as per drawing pages above. Start building walls by placing all the logs from front to back and then from side to side

3. **The logs are assembled with the tongues upwards**
4. Each log needs to be tapped home to log below using timber block supplied and a rubber mallet (E2).

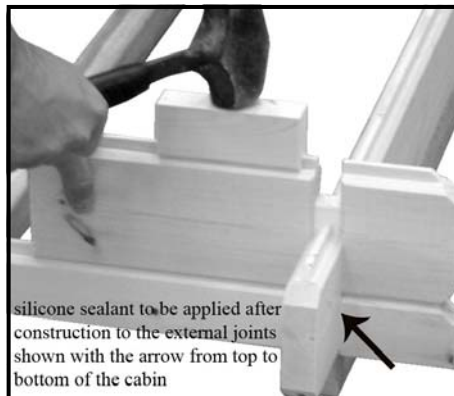

Fig E2

### F Inserting windows and doors

**UNDER NO CIRCUMSTANCES MUST THE DOOR OR WINDOW FRAMES BE NAILED TO THE LOGS. The logs must be free to move within the frame lots to allow for expansion and contraction. AS SOON AS YOU FIT DOOR UNIT FIT HANDLES AND UNLOCK DOOR**

1. Door unit must be placed into position after the first two layers of full logs have been assembled
2. Slide unit into aperture from above (Fig F1 & F2) ensuring unit is completely down and in position.



Fig F1 EXAMPLE



Fig F2

3. Window units are fitted as above (fig F3) when you have built up to the correct height



Fig F3 example

4. **Note** Door and window units do not require fixing to the logs
5. Once the door and window units are in place continue assembling the walls as before but slide the logs into the door or window frame (fig 54) from above then tap them down.



Fig F4

6. Continue building until you get to the height were the gable starts.
- 7.

### G Gables

#### See drawing pages

1. Assemble the gables as with the walls.
2. Once gables are in place knock down all the walls again as in fig E2 to ensure all the walls are fully home
3. Fix the gable with 1x80mm screw at each end (fig G1 and as shown on the drawing pages (Some screws may go into roof joists)
- 4.

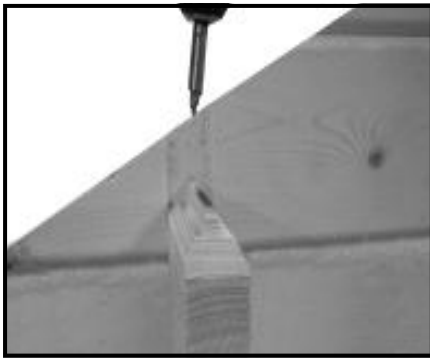

Fig G1

### H Roof joists

1. Fit roof bearers into slots provided in the gable sections (fig H1 & H2).



Fig H1

2. Measure the distance between each roof bearer and the roof bearers and walls to ensure all components are fully home before continuing.
- 3.



Fig H2 example

### I Roof boards

1. There are eaves edging strips for the building (2 places) (These may need cutting to fit).
2. Position the eaves edging strips ( fig I1 & I2) level at both ends with the gable angle (front and back walls) and screw to the wall with 50mm screws at approximately 400 centres.



Fig I1



Fig I2

3. The first roof board is now ready to be positioned (fig I3). **Bevels downwards**
4. **NOTE** only the final boards need trimming.

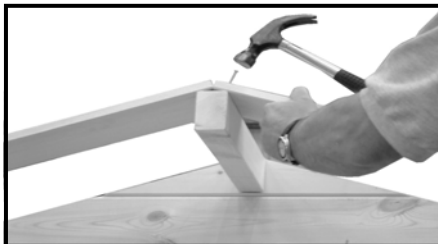

Fig I3

5. Start at the front, place the board level with the end of the roof bearers and central over the middle bearer to produce an even overhang (fig I3).
6. Fix into place at the roof bearers and angled eaves edgings using two 40mm ROUND HEAD nails at each bearer & eaves edging



Fig I4

7. The final roof board will need to be cut. Place it in position and measure the distance between the end of the roof bearers and the edge of the board. This will tell you how much you need to cut off (fig I4).
8. Next fit the roof edgings to the outer edges of the roof boards with 50 mm screws at approximately 300mm centres (Fig. I5).



Fig I5

### J Felt Roof

1. Measure the length of the roof and layout a roll and cut into lengths 20cm longer than the roof.(Fig J1).You can use a board as a straight edge.
2. Repeat with all the felt.



Fig J1

4. Starting at the lower edge (eaves) place 1 piece from front to back of the building.
5. An overhang of approximately 50mm should be allowed at the front and the back (all felt strips) and the length of the eaves edgings at the side (Fig J2 & J3).

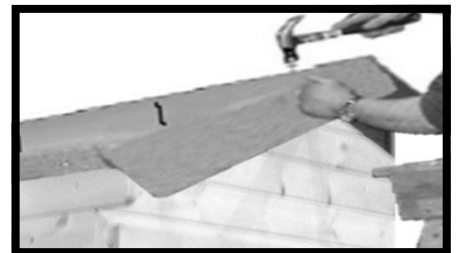

Fig J2

6. Secure with felt nails at approximately 100mm spacing. But only a couple along the high edge at this time (nailed with overlap).

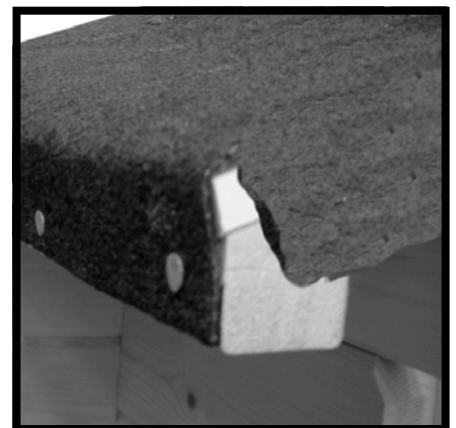

Fig J3

7. Repeat on the other side.
8. Place the next piece of felt over the high point of the roof (ridge) overlapping the lower pieces either side then nail as before.
15. Nail with felt nails at each roof bearer leaving space for fixing the Fascia's (either side of the ridge ).

## K Fascia

1. Fascia boards can now be drilled and screwed ( fig K1 ) with 1x 50mm screw at each roof bearer and the roof edgings.

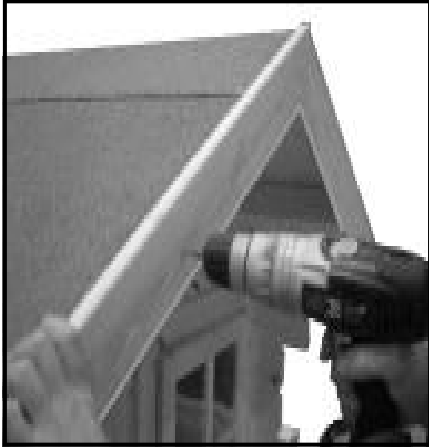

Fig K1

2. Drill diamond and screw with 2x50mm screws . (fig K2)

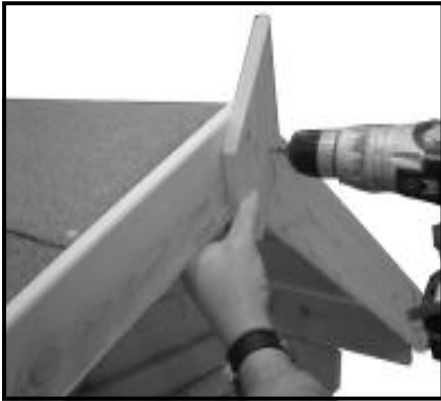

Fig K2

## L Floor

1. The floor is fitted working from front to back with 40mm nails **Bevels downwards**.
2. Position the first floorboard under the doorframe (Fig L1), with the groove against the wall.



Fig L1

3. Fix into position with two nails at each floor bearer (Fig L2 & L3).



Fig L2



Fig L3

4. Continue with remaining floorboards until you have three remaining.
5. Place these in position without nailing them down, as the last floorboard will require trimming.
6. Measure the distance between the last full board and the wall (Fig L4). This measurement is then marked on the final board and then cut to Fit , **leaving the groove on the board** .



Fig L4

7. Curl the boards up ( fig L5 ) to put it into position and nail the remaining boards before



Fig L5

8. Cut the skirting boards to suit and fix with 40mm oval nails at approx 400mm centres (fig L6)



Fig L6

## M Glazing

### After painting

1. **NOTE** ensure that you have treated the beading and the rebate where the glass fits before fixing the glazing.
2. Place glazing material into the aperture of each window.
3. Hold into position with four pieces of beading . The beading may need to be swapped around to get the best fit. When satisfied secure into position using 2x15mm panel pins per piece of beading. ( fig M1 )Repeat for all window and door apertures.

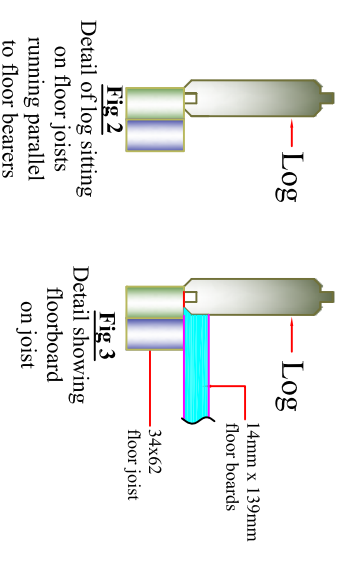
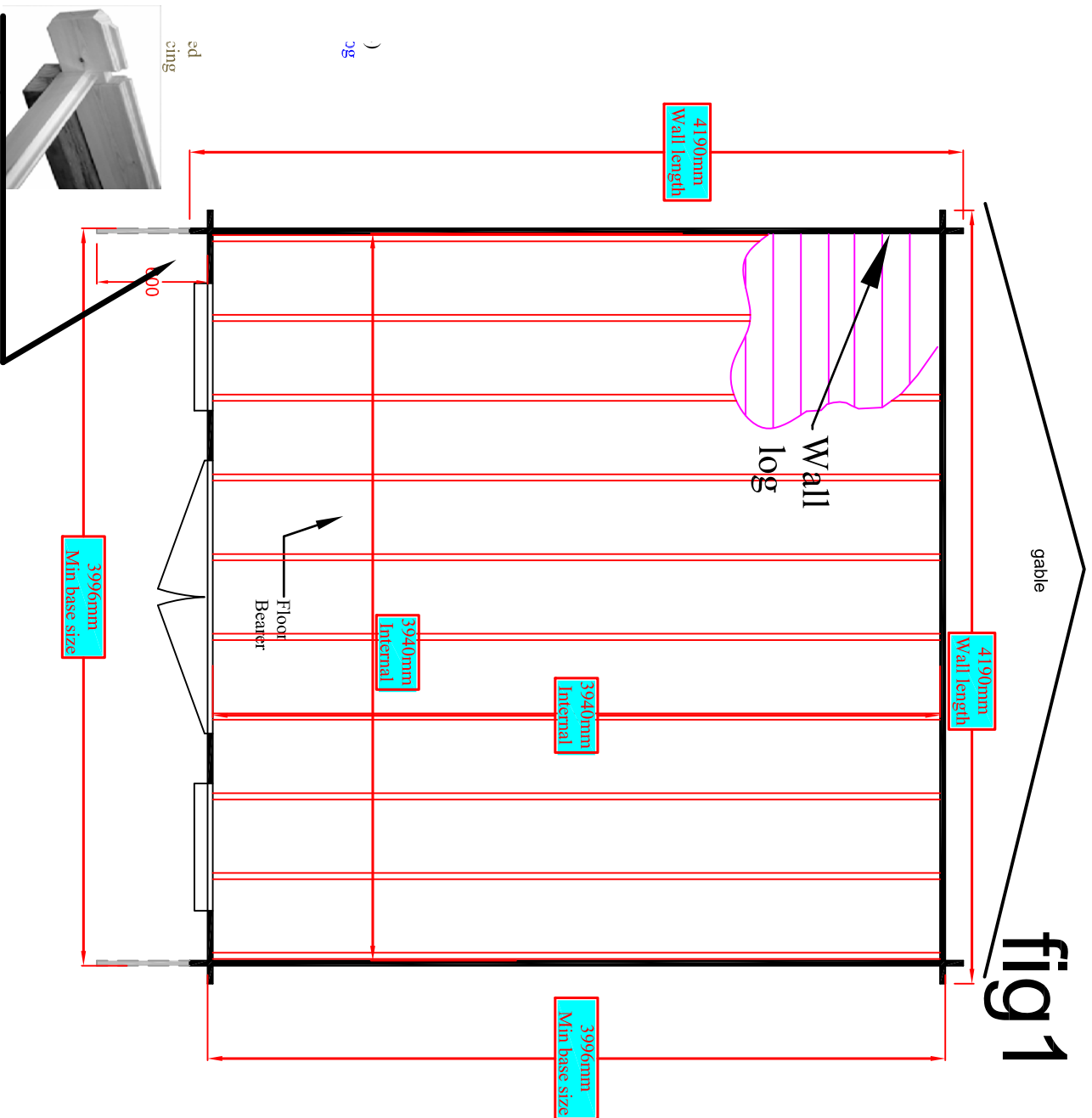

Fig M1



# Base details & Floor bearer layout

see page 2 for spacing



4190 x4190(14x14)

Caledonian 28mm log

FLOOR PLAN

Pressure treated

floor joists 38x63

12 x 3996

Floor boards

29 x 3940

Bearers may be joined

See front view for spacing

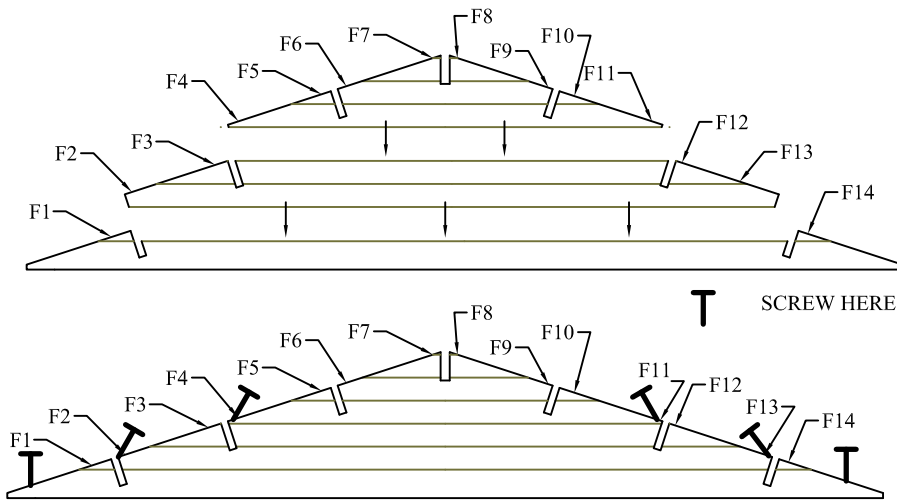

4190 x4190(14x14)  
Caledonian 28mm log

### FRONT

#### Parts list

- A1x1
- A2x1
- Cx16
- C1x2
- Dx16
- Ex16

## Front view

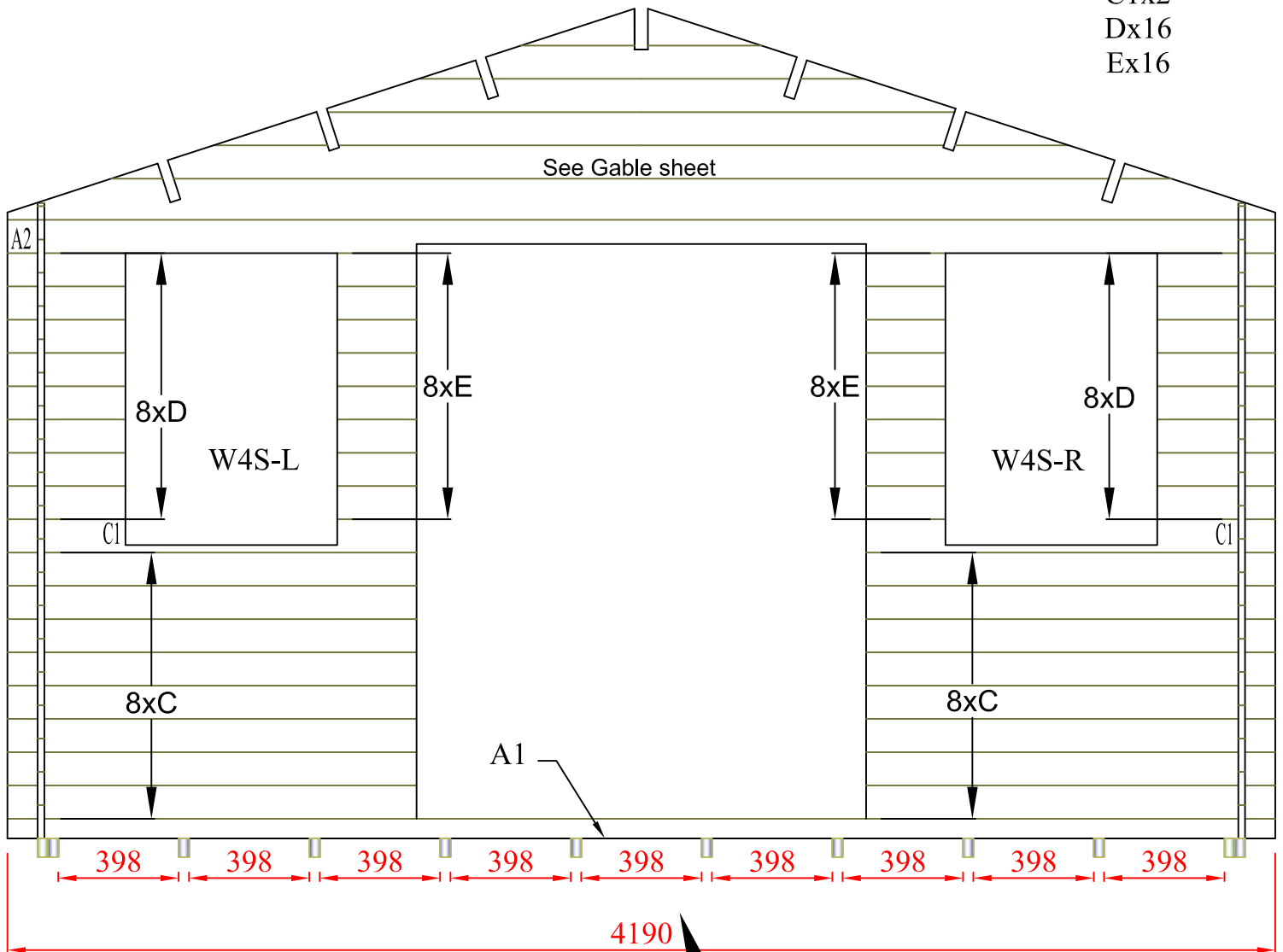

bearer spacing

# Back View

page3

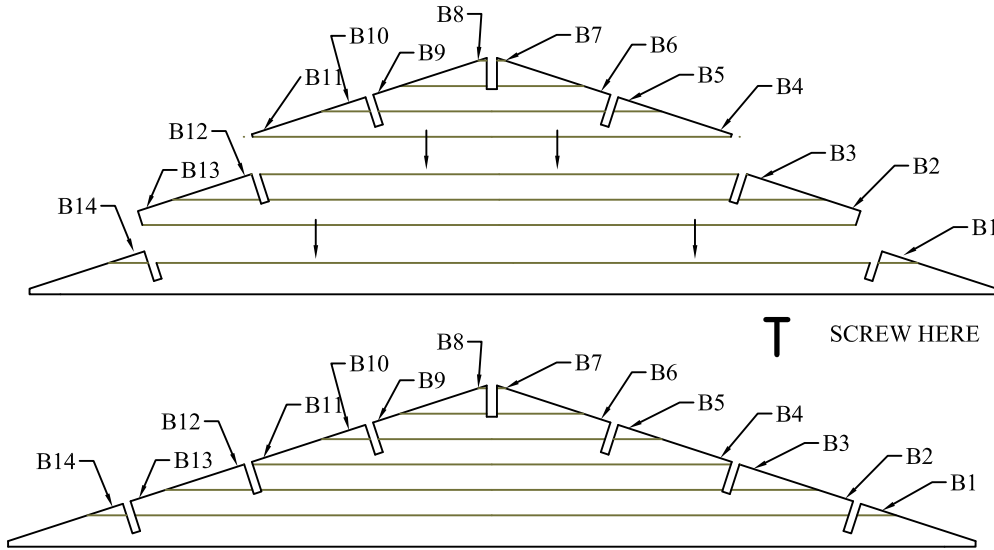

4190 x4190(14x14)  
Caledonian 28mm log

BACK  
Parts list  
A X 18  
A1 X 1

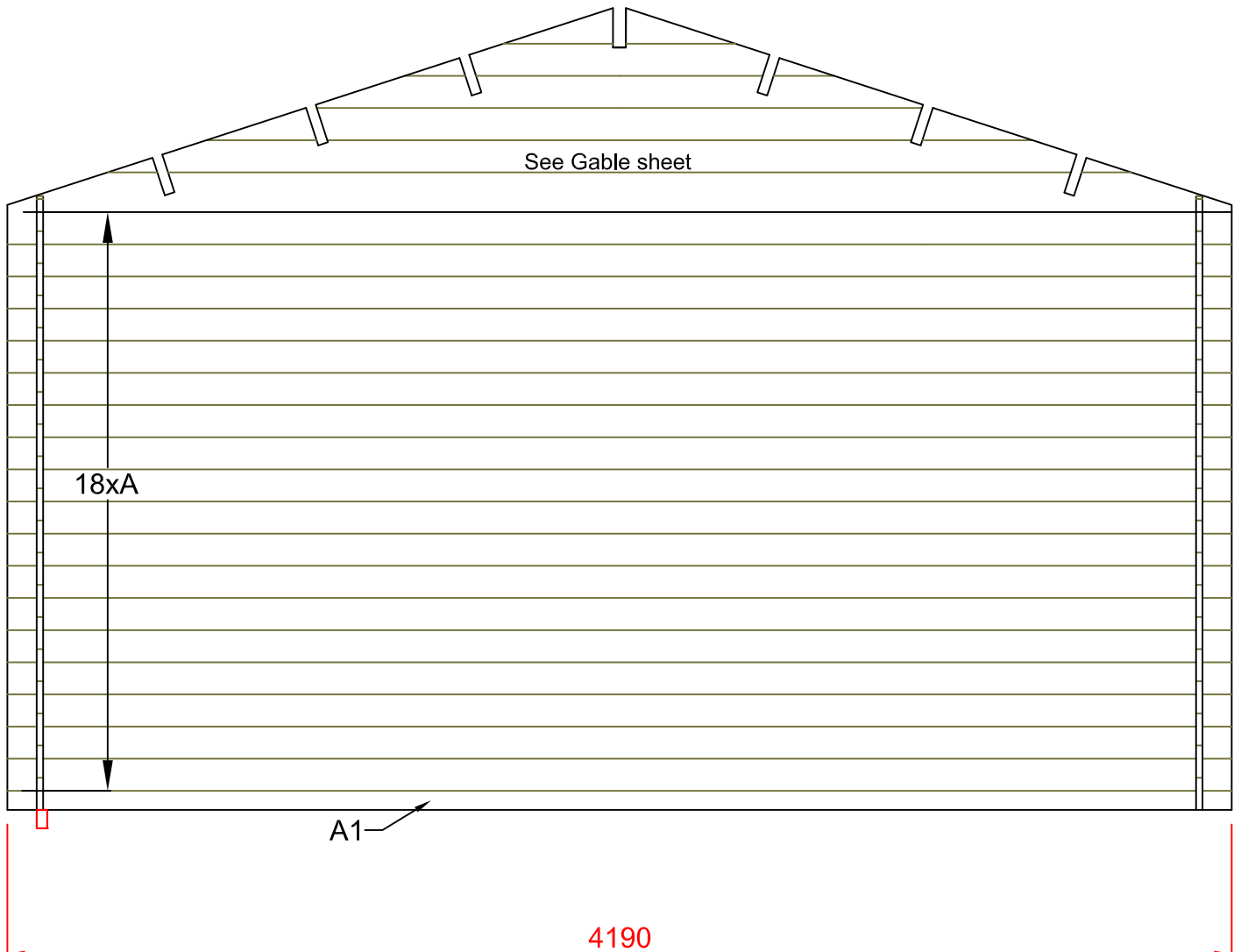

## LH side view

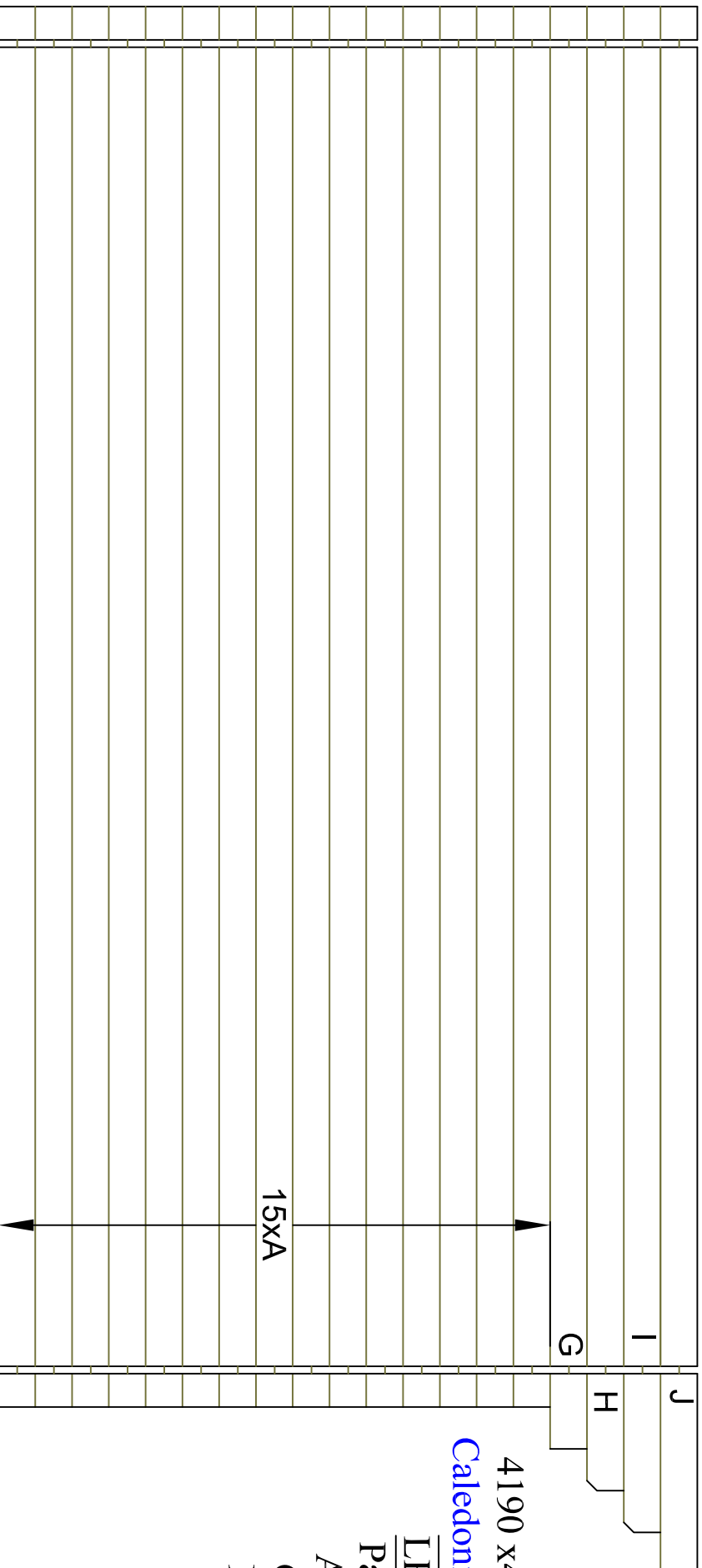

4190 x4190(14x14)

[Caledonian 28mm log](#)

- LH SIDE
- Parts list
- AX 15
- G X 1
- H X 1
- I X 1
- J X 1

4190

4068

# RH Side view

pages 5

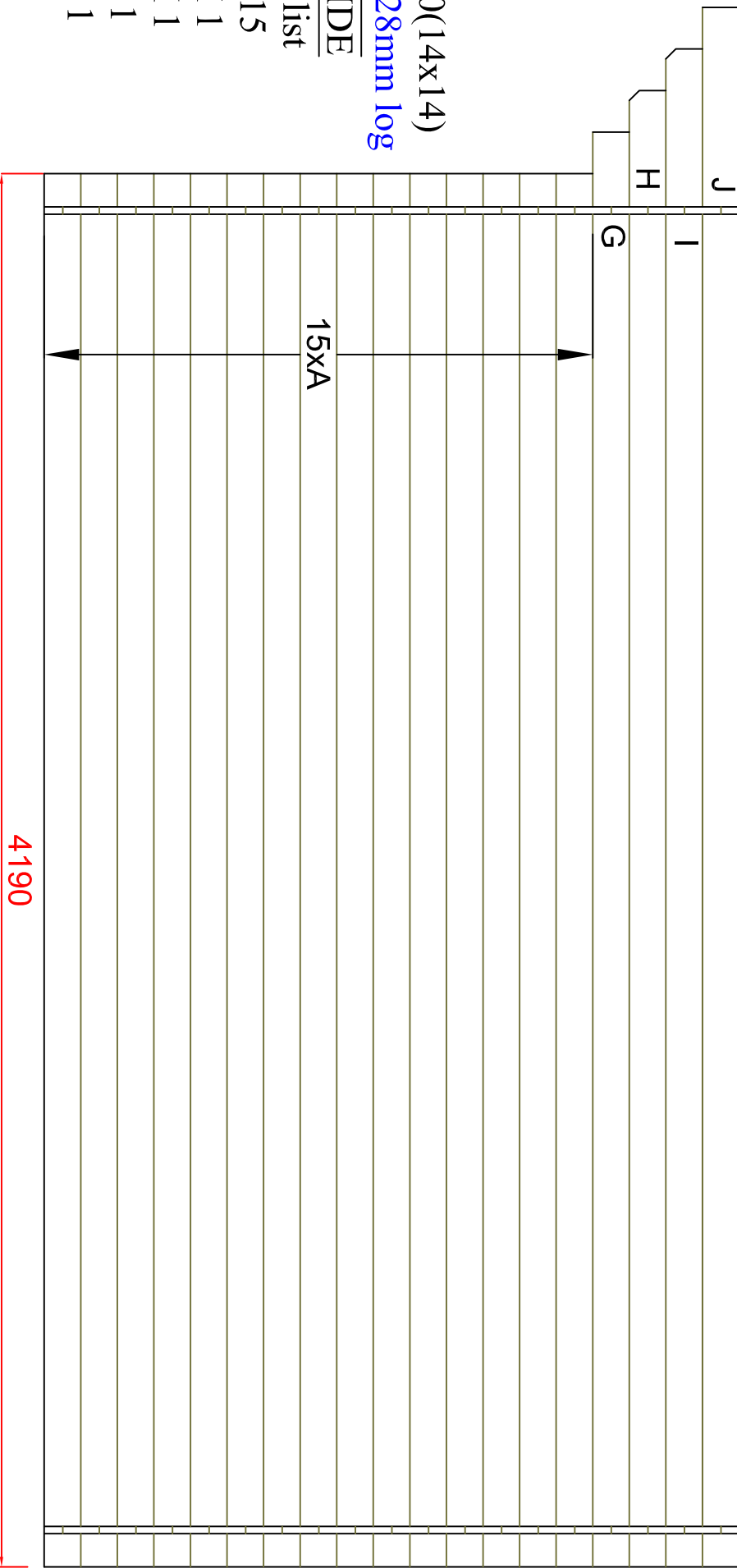
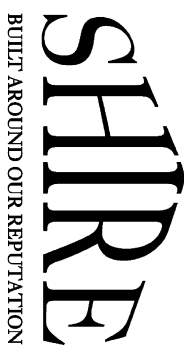

4190 x4190(14x14)

Caledonian 28mm log

- RH SIDE
- Parts list
- AX 15
- GX 1
- HX 1
- IX 1
- JX 1

# SHIRE

BUILT AROUND OUR REPUTATION

page6

## Roof Materials

4190 x4190(14x14)

[Caledonian 28mm log](#)

ROOF ASSY

Parts list

**7 Roof bearers**

**2 Angled eaves  
edging strips**

**2 Angled roof edgings**

68 Roof boards

2300 long

