

7x7 PRESSURE TREATED OVERLAP DOUBLE DOOR APEX SHED WITH 2 WINDOW SIDES - ASSEMBLY INSTRUCTIONS

ISSUE 0110REM



IMPORTANT:
ASSEMBLY OF THIS SHED REQUIRES TWO PEOPLE

SHOULD YOU REQUIRE ANY ADDITIONAL GUIDANCE WITH THE ASSEMBLY OF YOUR SHED PLEASE CONTACT OUR TECHNICAL HELP LINE ON 0844 248 9853. **IMPORTANT NOTICE:** THIS STANDARD FIXING PACK IS UTILISED WITH SEVERAL DIFFERENT BUILDINGS. PLEASE ENSURE THAT YOU ARE USING THE CORRECT INSTRUCTION DOCUMENT FOR ASSEMBLY OF THE SHED YOU HAVE PURCHASED.

IMPORTANT: RETAIN FOR FUTURE REFERENCE: READ CAREFULLY!

Thank you for choosing this garden building manufactured by the UK's largest manufacturer of timber garden products. In order to gain the most benefit from it, please note the following:
- Exercise particular care and follow instructions whilst cutting the roofing felt. If it is cut incorrectly, additional roofing felt can be inexpensively purchased from most good DIY retailers or garden centres.

- This building is pre-treated to ensure longevity of all timber components and protect against rot. This may leave a colour difference on some parts that will even out as the moisture contents stabilises.

- If there are any technical queries with the product, please contact our customer help line on 0844 248 9853 between the hours of 8.30 am and 5.00 pm Monday to Friday.

- Please ensure that you thoroughly check all component parts for quantity and quality before you commence building the product. If there are any missing parts, please contact the help line as shown immediately. The manufacturer cannot be held liable for damaged items once any part of the product has been fitted or altered in any way (e.g. Painted)

- Timber is a natural material. It will shrink and swell as a result of varying moisture content.

- Please keep all plastic bags and small parts away from children in order to reduce the risk of suffocation.

- This product must be built on a solid level base.

REQUIRED TOOLS : (NOT SUPPLIED)

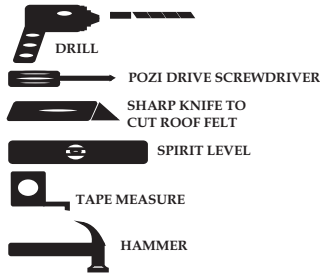

FP10 (FIXING PACK) CONTENTS :

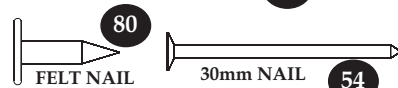

PLEASE NOTE: ALL SCREWS AND NAILS SHOWN BELOW AND IN INSTRUCTIONS ARE TO SCALE TO ASSIST IN IDENTIFICATION OF REQUIRED FIXINGS.

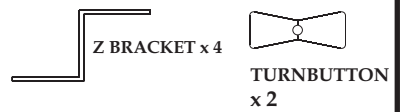
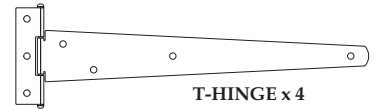
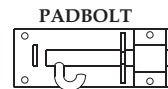

COMPONENTS INCLUDED

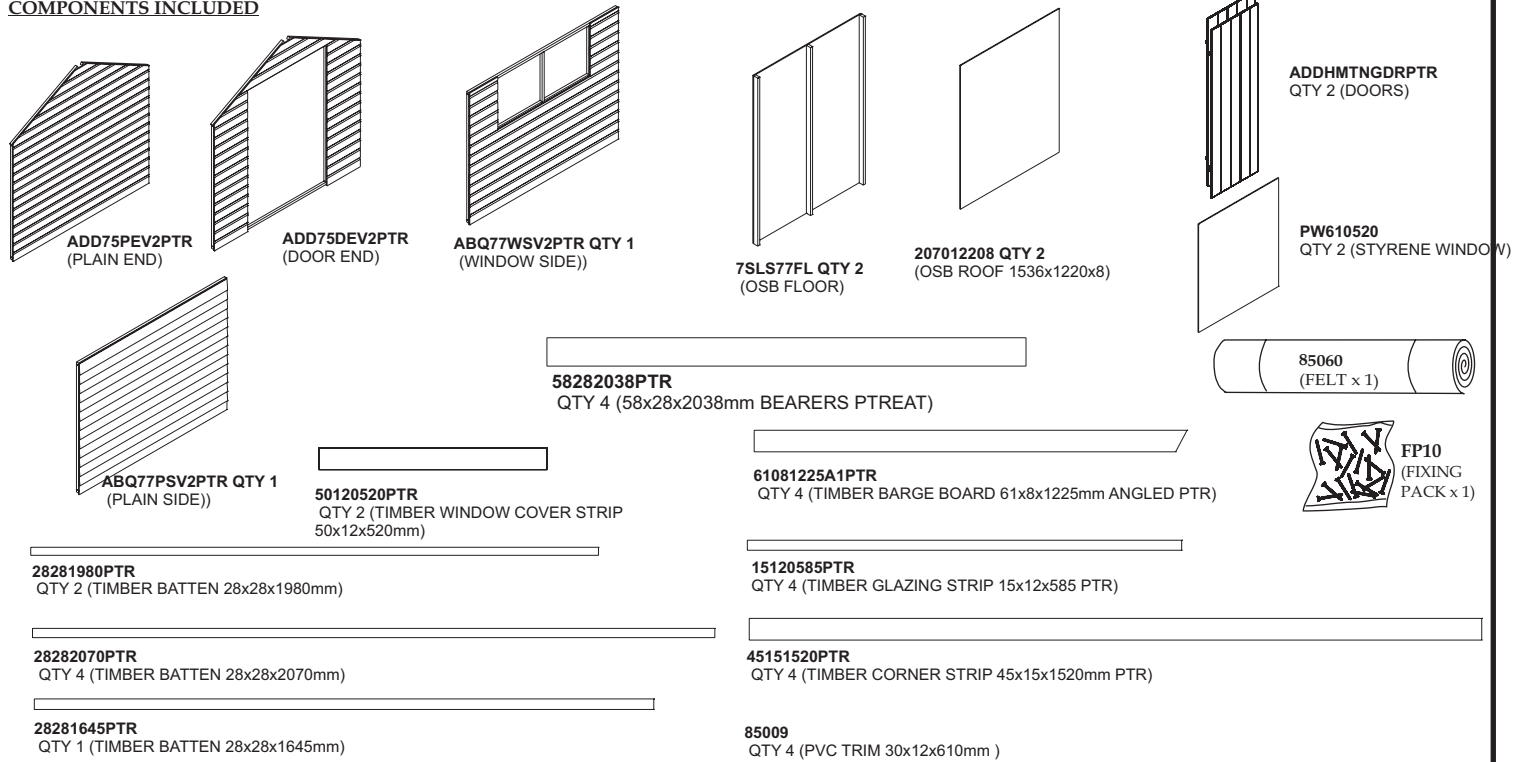

1

PLACE TWO 58282038PTR BATTENS ON THE UNDERSIDE OF EACH 7SLS77FL FLOOR SECTIONS. FIX IN PLACE USING 12 X 30MM NAILS FOR EACH BATTENS

SECURE THE 2 7SLS77FL (FLOOR SECTIONS) TOGETHER USING 4x50mm SCREWS AS SHOWN

2

A) FASTEN TWO HINGES TO EACH ADDHMTNGDRPTR (DOOR) AS SHOWN USING 30mm SCREWS. SCREWS MUST SECURE INTO THE TWO HORIZONTAL BATTENS ON THE BACK OF THE ADDHMTNGDRPTR (DOOR).

B) PLACE ADD75DEV2PTR (DOOR END) FACE UP ON GROUND. LAY EACH ADDHMTNGDRPTR (DOOR) ON ADD75DEV2PTR (DOOR END) OF SHED ENSURING THAT THE DOORS ARE SQUARE WITH EQUAL GAPS TO LEFT AND RIGHT, AND SECURE HINGES TO ADD75DEV2PTR (DOOR END) WITH 30mm SCREWS.

3

ADD75PEV2PTR

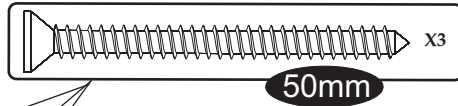

50mm

ABQ77PSV2PTR

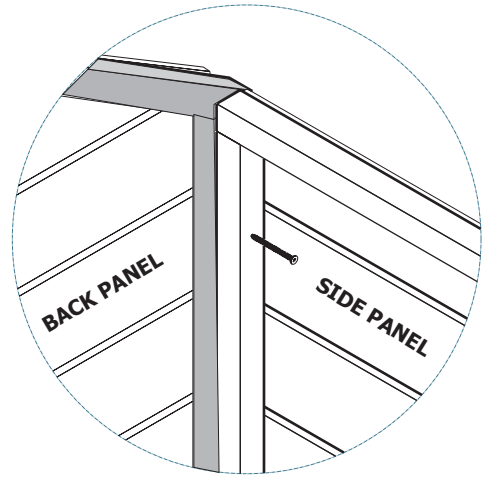
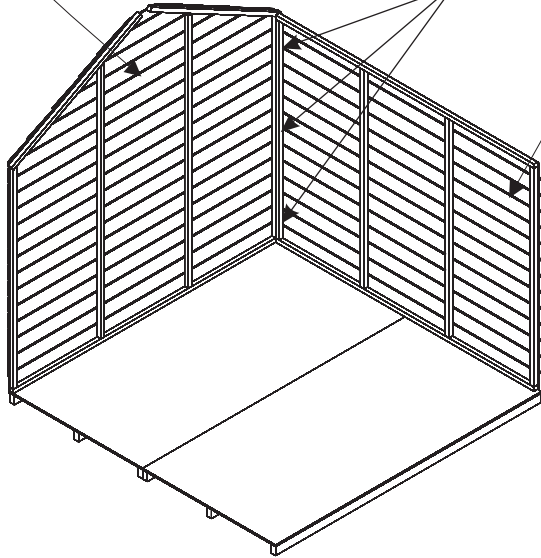

POSITION ADD75PEV2PTR (PLAIN END) OF SHED ONTO FLOOR SO THAT THE LEFT AND RIGHT HAND EDGES OF THE PANEL ARE FLUSH WITH THE EDGES OF THE FLOOR. PLACE ABQ77PSV2PTR (SIDE PANEL) ONTO THE FLOOR AND PLACE UP AGAINST ADD75PEV2PTR (END PANEL). SECURE ABQ77PSV2PTR SIDE PANEL TO ADD75PEV2PTR (END PANEL) USING 3 x 50mm SCREWS PLACED AS SHOWN.

DO NOT SECURE THE PANELS TO THE FLOOR AT THIS POINT.

4

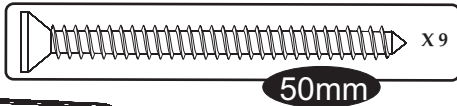

50mm

ABQ77WSV2PTR

ADD75DEV2PTR

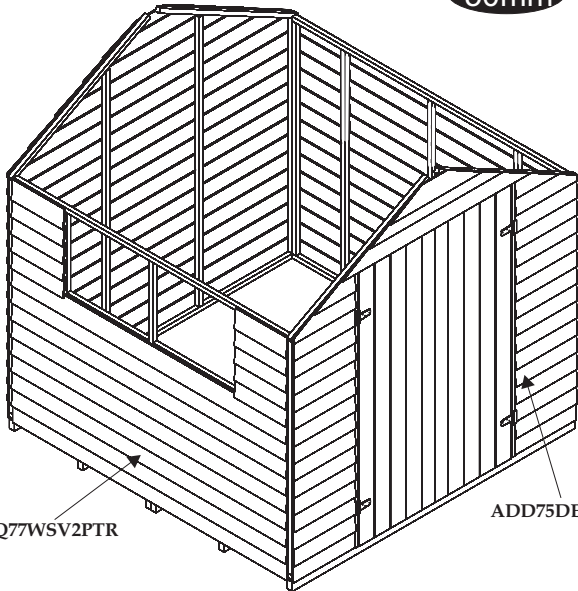

USING PROCEDURE OUTLINED IN STEP 3, POSITION AND SECURE THE REMAINING ABQ77WSV2PTR (WINDOW PANEL) AND ADD75DEV2PTR (DOOR END)

5

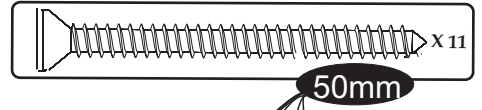

50mm

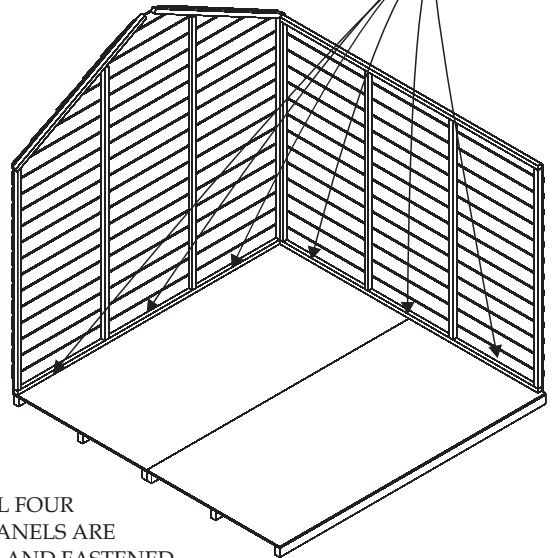

ONCE ALL FOUR OF THE PANELS ARE IN PLACE AND FASTENED TOGETHER, SECURE THEM TO THE FLOOR USING 50mm SCREWS. EACH PANELS REQUIRE 3 SCREWS BUT ONLY 2 SCREWS ARE REQUIRED FOR ADD75DEV2PTR (DOOR END). IT IS VITAL THAT ALL SCREWS ARE POSITIONED SO THAT THEY LOCATE INTO

6

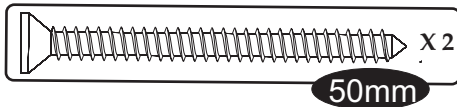

50mm

STAND INSIDE SHED AND WITH DOOR TO YOUR LEFT OPEN, ATTACH 28281645PTR (BATTEN) TO DOOR ON YOUR RIGHT WITH TWO 50mm SCREWS. IT IS VITAL THAT THERE IS AN EQUAL GAP BETWEEN THE 28281645PTR (BATTEN) AND THE DOOR OPENING AT TOP AND BOTTOM. SCREW MUST LOCATE THROUGH 28281645PTR (BATTEN) INTO EACH OF THE TWO HORIZONTAL BATTENS ON THE DOOR. ONCE 28281645PTR (BATTEN) IS IN PLACE FASTEN A TURN BUTTON TO THE TOP AND BOTTOM OF IT WITH A 30mm SCREW FOR EACH.

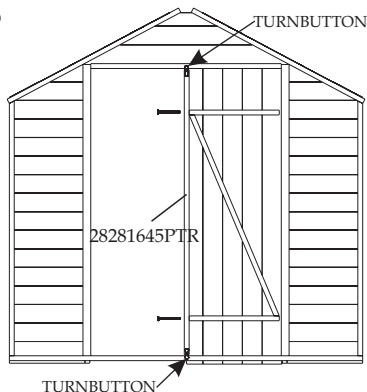

7

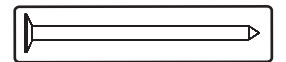

PLACE 207012208 (OSB ROOF) ON TOP OF 28282070PTR (BATTEN) MAKING SURE THAT IT IS FLUSH AGAINST THE EDGE AND CORNERS OF 207012208 (OSB ROOF). SECURE IN PLACE USING 30mm NAILS THROUGH THE (OSB ROOF) INTO THE 28282070PTR (BATTEN) AT 300mm INTERVALS. REPEAT THE PROCESS WITH ANOTHER 28282070PTR (BATTEN) BUT MAKING SURE IT IS OFFSET FROM THE EDGE BY 18mm.

DO THIS FOR BOTH ROOF SECTIONS

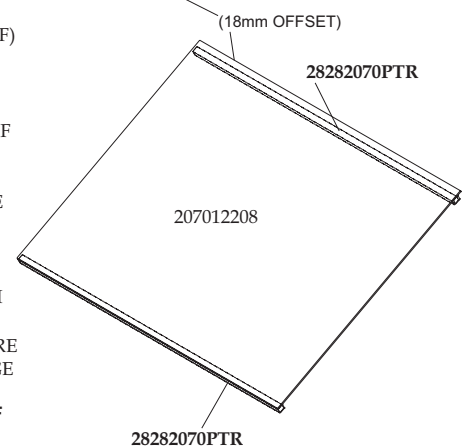

8

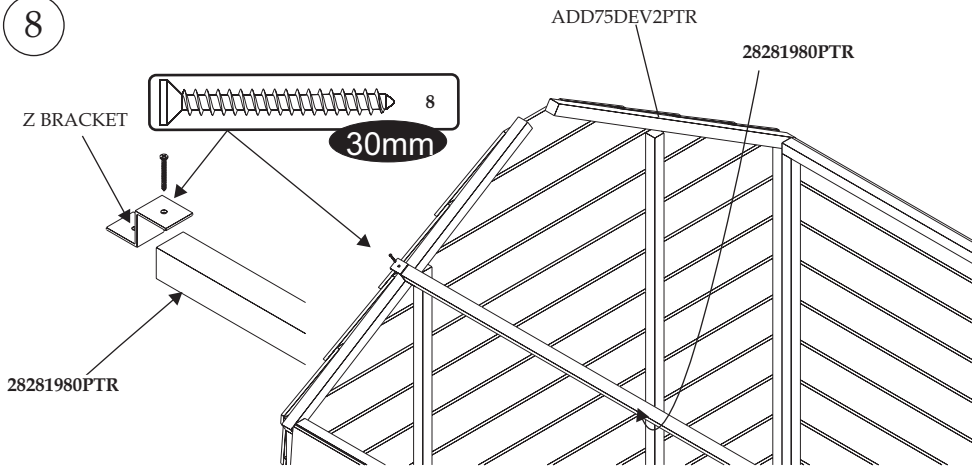

SECURE 1 "Z" BRACKET TO BOTH ENDS OF A **28281980PTR** (BATTEN) WITH A 30mm SCREW. PLACE **28281980PTR** (BATTEN) WITH "Z" BRACKETS BETWEEN ENDS OF SHED SO THAT THE "Z" BRACKET SITS ON TOP OF THE END SECTION FRAMEWORK AND UNDER THE ROOF BATTEN. THE **28281980PTR** (BATTEN) WITH "Z" BRACKETS SHOULD BE PLACED APPROXIMATELY HALF WAY BETWEEN THE SIDE AND THE MIDDLE OF THE SHED AND THEN SECURED AT BOTH ENDS WITH A 30mm SCREW. REPEAT PROCEDURE WITH SECOND **28281980PTR** (BATTEN) AND REMAINING 2 "Z" BRACKETS.

9

RIDGE BRACKET

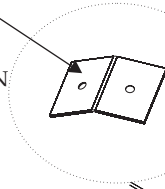

ONCE BOTH **207012208** (ROOF SECTIONS) ARE IN PLACE, SECURE THEM TOGETHER ON THE INSIDE OF THE SHED WITH THE PROVIDED RIDGE BRACKET. THE BRACKET MUST BE SECURED TO THE HIGHEST BATTEN ON EACH **207012208** (ROOF SECTION) WITH 2x30mm SCREWS AND SHOULD BE POSITIONED CENTRALLY BETWEEN **ADD75PEV2PTR** (BACK END) AND **ADD75DEV2PTR** (DOOR END)

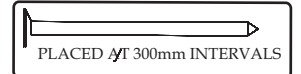

PLACE ONE OF THE ASSEMBLED **207012208** (ROOF) SECTIONS ON TOP OF THE SHED. WHEN IN PLACE, THE **207012208** (ROOF) SECTION SHOULD OVERHANG BY EQUAL AMOUNTS AT EITHER END OF THE SHED AND SHOULD BE POSITIONED SO THAT WHEN BOTH **207012208** (ROOF) SECTIONS ARE IN PLACE THEY MEET AT A POINT. SECURE IN PLACE WITH 30mm NAILS PLACED AT 300mm INTERVALS INTO THE FRAMEWORK OF THE SIDES OF THE SHED.

REPEAT THIS PROCEDURE FOR THE REMAINING ROOF SECTION.

10

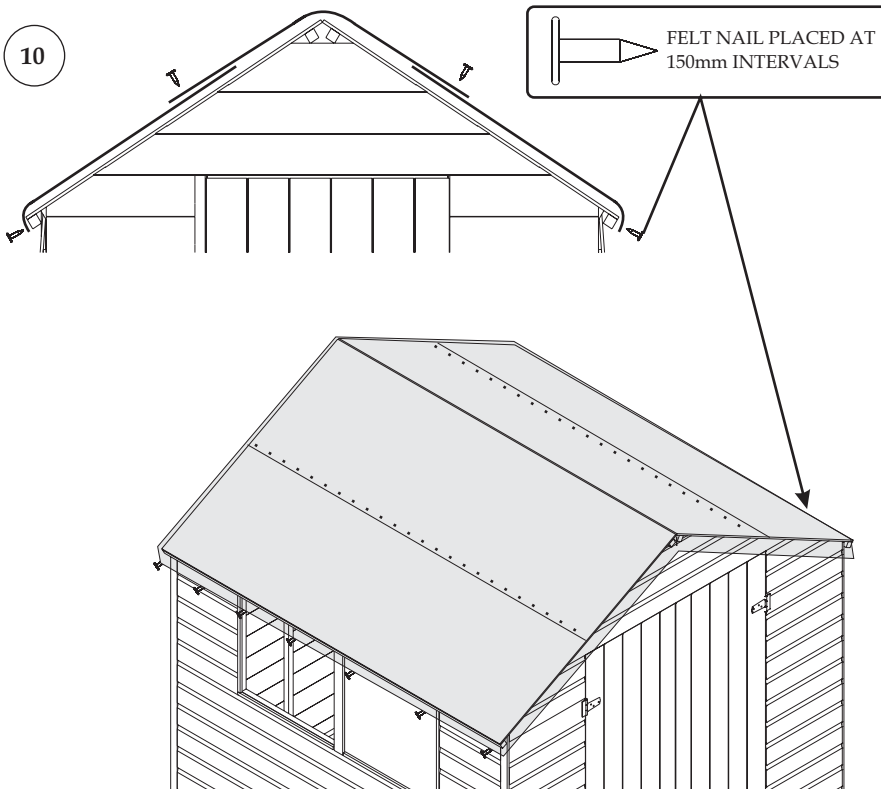

OPEN ROOFING FELT AND ROLL OUT FLAT ON GROUND. CUT THE FELT INTO THREE EQUAL LENGTHS. PLACE THE FIRST PIECE OF FELT ON THE ROOF SO THAT IT OVERLAPS EQUAL AMOUNTS AT EITHER END OF THE SHED, AND BY APPROXIMATELY 40mm AT THE EAVE (LOWER) SIDE OF THE ROOF. SECURE FELT TO ROOF WITH FELT NAILS PLACED AT 150mm INTERVALS. CUT AND FOLD FELT AT CORNERS AND SECURE FOLD WITH A FELT NAIL. REPEAT PROCEDURE FOR OPPOSITE SIDE OF ROOF. PLACE THE THIRD PIECE OF FELT ON THE APEX OF THE ROOF SO THAT IT OVERLAPS EQUALLY AT EITHER END AND EITHER SIDE OF THE ROOF. SECURE FELT TO ROOF WITH FELT NAILS PLACED AT 150mm INTERVALS ALONG EITHER SIDE.

11

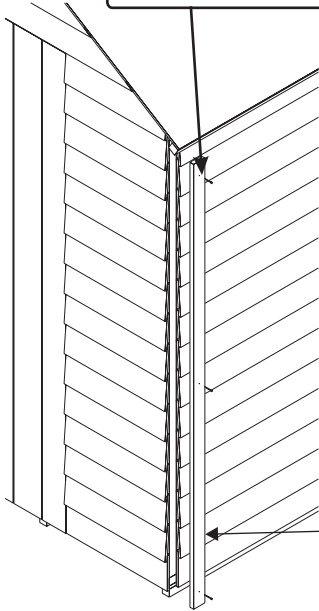
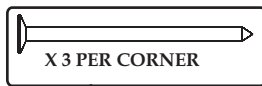

SECURE A **45151520PTR** (CORNER STRIP) TO EACH OF THE FOUR CORNERS WITH 3 x 30mm NAILS PER STRIP. NAILS SHOULD BE PLACED APPROXIMATELY AS SHOWN. THE BOTTOM OF **45151520PTR** (CORNER) STRIP SHOULD BE IN LINE WITH BOTTOM OF CLADDING ON SIDE PANELS.

45151520PTR

12

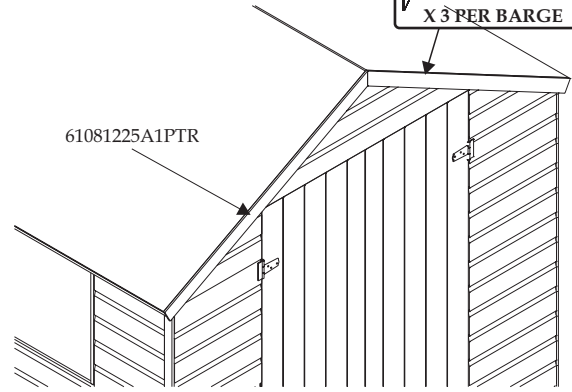
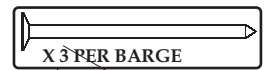

POSITION **61081225A1PTR** (BARGE BOARDS) ON BOTH ENDS OF SHED SO THAT THE TOP EDGE IS IN LINE WITH THE TOP EDGE OF THE ROOF AND THE POINT OF THE **61081225A1PTR** (BARGE BOARD) MEETS UP WITH THE HIGHEST POINT OF THE ROOF. SECURE EACH **61081225A1PTR** (BARGE BOARD) IN PLACE WITH 3 x 30mm NAILS PLACED AS SHOWN ABOVE. TRIM OFF ANY EXCESS FELT THAT IS SHOWING BELOW THE **61081225A1PTR** (BARGE BOARDS).

61081225A1PTR

13

PLACE AN **85009** (PLASTIC "Z" STRIP) ACROSS BOTTOM OF EACH WINDOW OPENING. THE LONG EDGE OF THE Z SHOULD FACE DOWN ON OUTSIDE OF SHED. SECURE EACH IN PLACE WITH 3 PANEL PINS. PLACE **PW610520** (WINDOWS) OVER WINDOW OPENINGS FROM OUTSIDE OF SHED. PLACE ONE OF THE **15120585DTR** (GLAZING STRIPS) ALONG THE BOTTOM OF THE WINDOW ON THE OUTSIDE OF THE SHED, MAKING SURE IT IS FLUSH AGAINST THE CLADDING, AND SECURE IN PLACE WITH 3 PANEL PINS. (DO THIS FOR BOTH WINDOWS). PLACE **50120520PTR** (COVER STRIP) AGAINST THE CENTRAL WINDOW BEAM AND OVER THE **PW610520** (WINDOWS) SECURING IN PLACE WITH 2 30MM SCREWS, TAKING CARE NOT TO HIT ANY OF THE **PW610520** (WINDOWS). PLACE THE REMAINING (2) **15120585DTR** (GLAZING STRIPS) TO THE OUTSIDE OF EACH **PW610520** WINDOW ON THE OUTSIDE OF THE SHED AND SECURE EACH IN PLACE WITH 3 PANEL PINS.

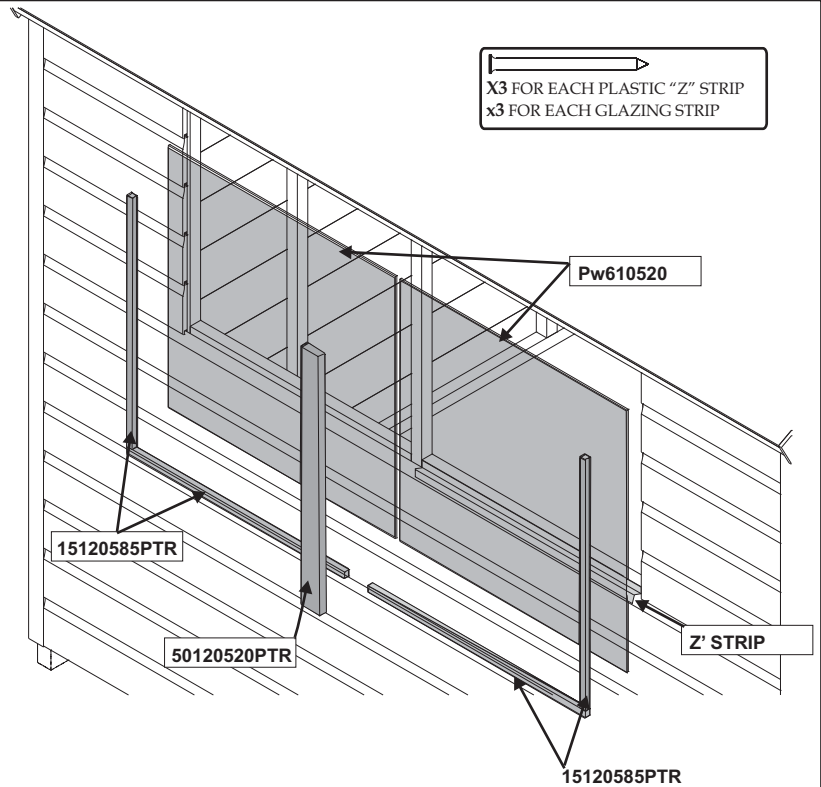

X3 FOR EACH PLASTIC "Z" STRIP
X3 FOR EACH GLAZING STRIP

PW610520

15120585DTR

50120520PTR

Z' STRIP

15120585DTR

14

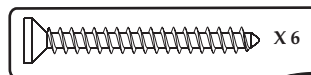

30mm

SECURE PAD BOLT TO OUTSIDE OF LH **ADDHMTNGDRPTR** (DOOR) USING 3x30mm SCREWS. THE SCREWS MUST LOCATE INTO THE SHORT HORIZONTAL BATTEN ON THE INSIDE OF THE DOOR. SECURE RECEIVER TO RH **ADDHMTNGDRPTR** DOOR USING 2 x30mm SCREWS.

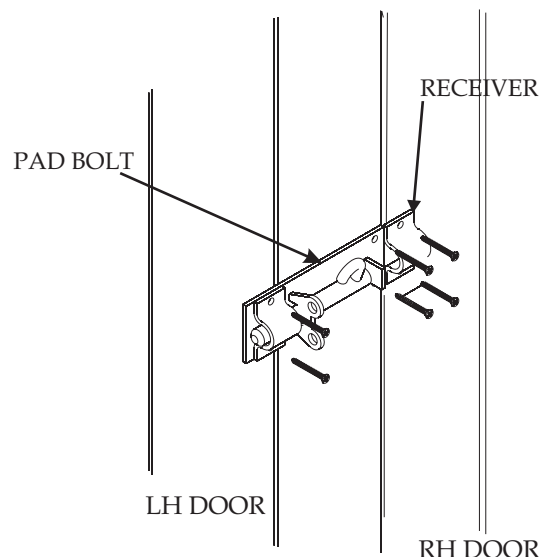

PAD BOLT

RECEIVER

LH DOOR

RH DOOR