

# Instruction pack

R11

# Kinver 44

# 4190x(4190)5690

34mm

**NO OTHER PARTS REQUIRED**

**CHECK ALL PARTS BEFORE ASSEMBLY OR  
EMPLOYING TRADESPEOPLE**



**LOG SHEET**

Building: **Kinver 44**  
 Building Size: **4190x(4190)5690**  
 Date: **14-Sep-11**

LOG 28mm 1MM

**ID no see packing sheet**



Log	Length	Quantity
A	4190	43
A1	4190	2
A2	4190	1
A3	4190	1
C	2699	8
C1	2699	1
D	721	31
E	592	8
F	2084	7
H	4290	1
I	4440	1
I1	4440	1
J	4690	2
K	821	1
0	0	0
V1	1500	6
v1t	1500	2
v2	990	4
v2b	990	2
v2t	990	2
v3	300	6
v6	224	30
v6t	224	2
0	0	0
0	0	0
0	0	0
0	0	0
0	0	0
0	0	0
SPARE LOGS		
A	2	0
C	1	0
F	1	0

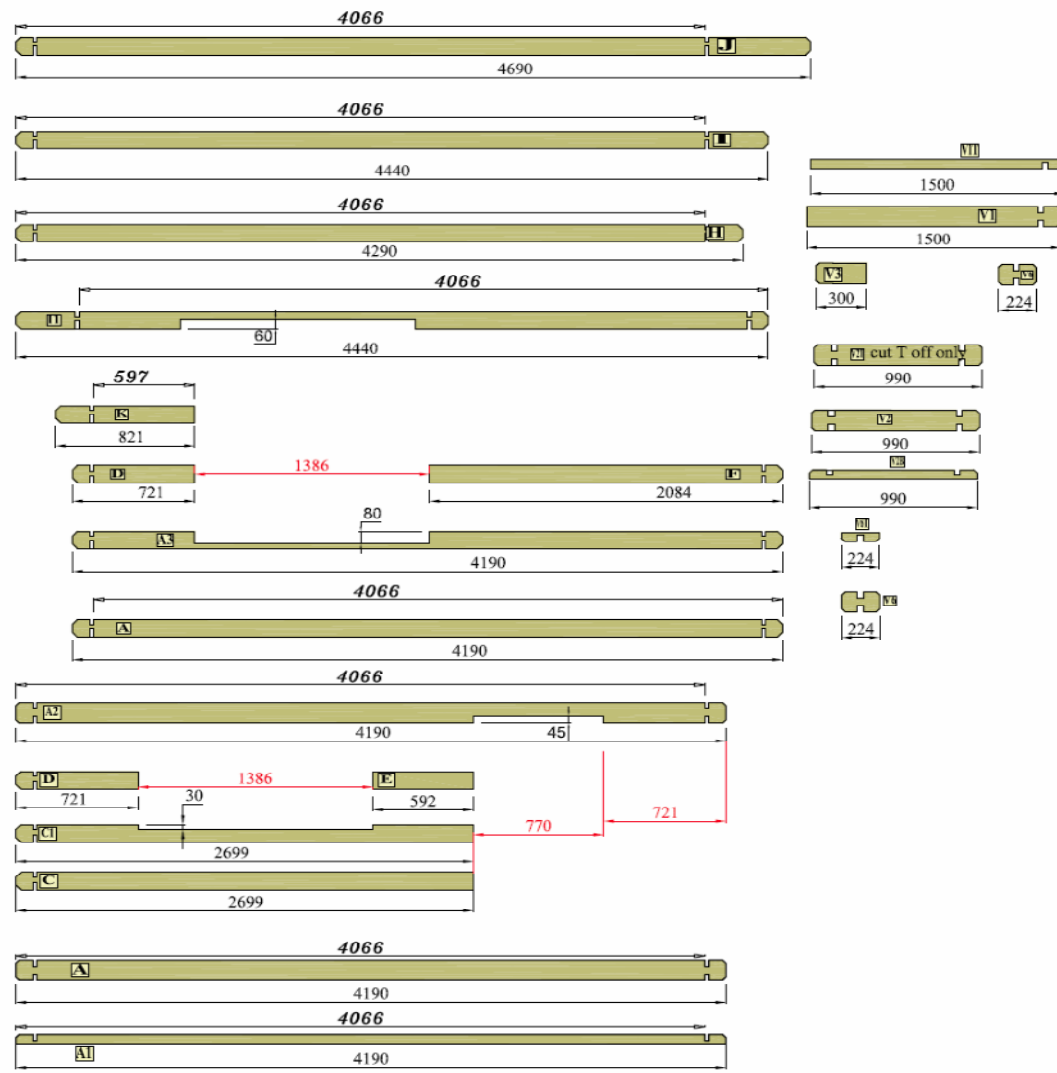

**120x40 BEARER 0**

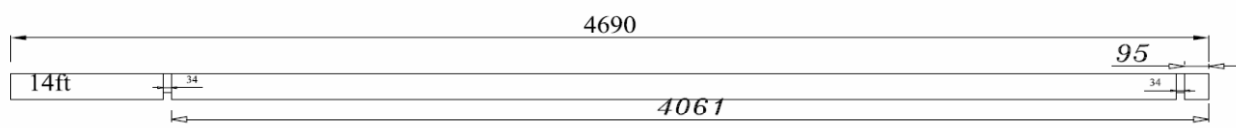



W4-D WINDOW  
INNER FRAME ASSEMBLY

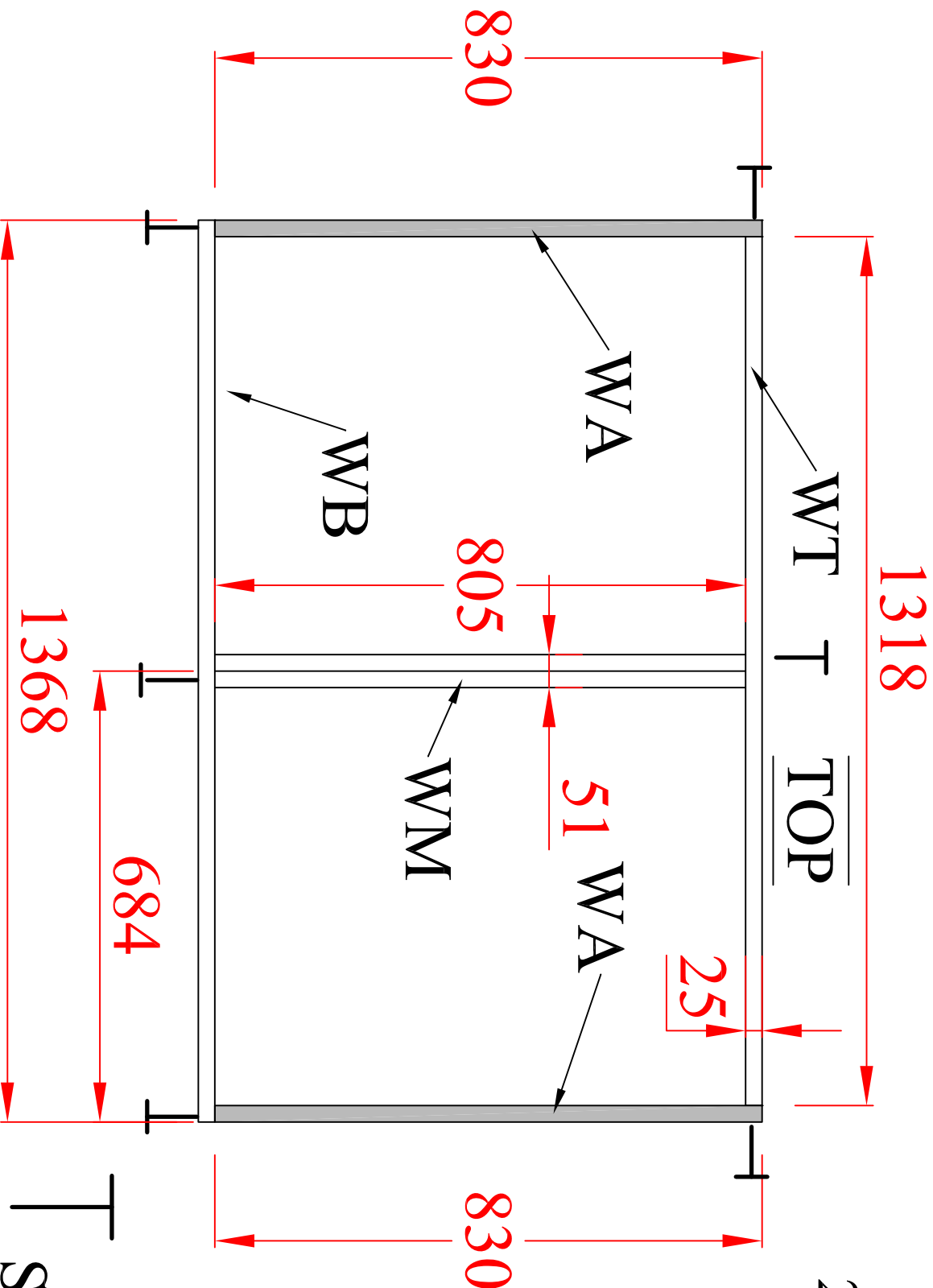

Window

inner frame

WA, WB, WT

25xlog thickness

WM

51xLog

thickness

(2 pieces fixed

together)

T  
SCREW HERE

# W4-D WINDOW

## OUTER FRAME ASSEMBLY

633-4	776-4	rubber
1490		drip bar

### TOP

WD 1527

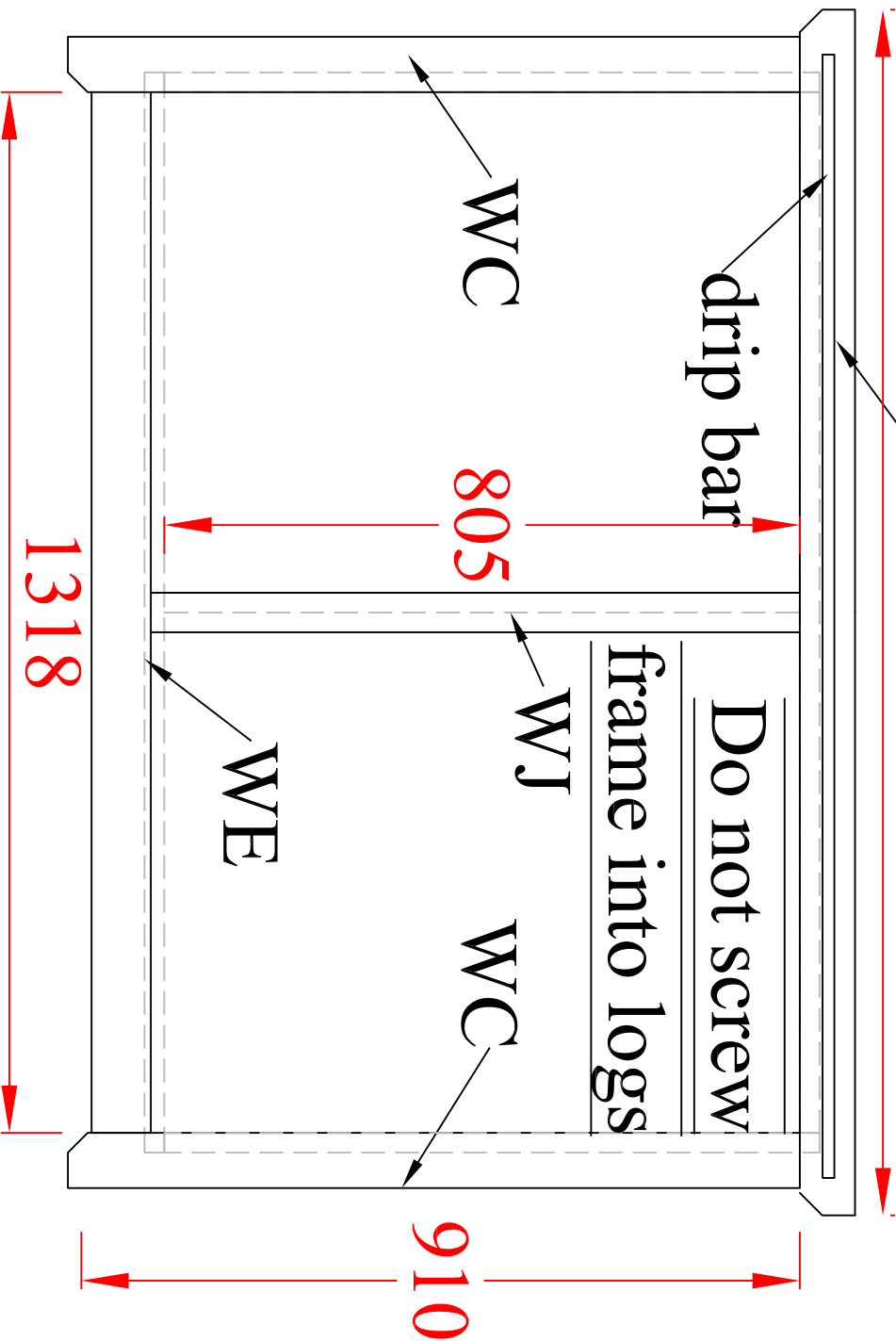

**SHIRE**  
BUILT AROUND OUR REPUTATION



## Assembly of Kinver 44 pine lodge ©

Thank you and congratulations on the purchase of your Shire pine lodge. We believe that this product will give you many years of excellent service. This is a natural product manufactured to a high standard therefore if you have any queries or experience any difficulties then please contact our customer service hotline on **01945 46 89 10 01945 46 89 11 01945 46 89 12**  
 Normal office hours: 8.30am to 5.00pm Monday to Friday.  
 Answer phone all other times.

### Preparation of base

The base onto which you build your Cabin needs to be flat and level. We only recommend you use concrete that is a minimum of 10 cm thick

**Base size least 4000mm x 5500mm**

Please refer to section B and drawing pages 1 & 2 .

Please note that the corner joints protrude over the edge of the base.

### Treatment/care of your pine lodge

#### Tools required

- Hammer
- Rubber mallet
- Spirit level
- Stepladder
- Battery-powered drill/screwdriver
- 8mm drill
- 3mm drill
- Tape measure
- Gloves
- Sharp knife and saw
- string
- Oil for lock

- All timber must be dry to apply the timber treatment.
- Treat with a suitable decorative wood finish immediately. We recommend that you treat the door and window glazing rebates and beading with a top quality timber treatment before assembly and treat the entire building as soon as assembly is complete, we further recommend that all pieces are treated and again within 3 months of assembly and again at least annually or as frequently as the instructions on the product used recommends.
- **Note** the back of the door and window units unscrew so they can be removed for painting
- We would also remind you that you would rarely (if ever) be able to re-treat the underside of the floor boards following assembly.
- We strongly recommend that the underside of the floor is treated an absolute minimum of twice.
- The floor bearers are pressure treated and don't need to be treated although you may if you wish. We also recommend that you seal the external corner joints (fig C2) with silicone sealant (not supplied)
- **LUBRICATE LOCK** It is extremely important that you lubricate your lock through the key hole and all moving parts as soon as possible after assembly and at least at monthly intervals thereafter . Also ensure that you regularly operate the lock especially during the winter or when not in use.

- ◆ See drawings for log quantities
- ◆ See yellow parts list sheet please quote ID number and your order number in all correspondence
- ◆ \* Note the Angled eaves edging, Eaves fascia & roof edging may be supplied in shorter lengths.

### IMPORTANT!

#### Check all components before commencing with the construction of your Kinver

1. Keep all timber dry or your building will not fit together.
2. We also recommend that you seal the corner log joints with silicone sealant (not supplied).
3. We recommend a minimum of two people required for assembly.
4. Read through all the instructions before constructing your pine lodge.
5. You will see there is a set of lettered drawings showing each side of the building. You will find these letters printed at one end of each log or in the slot.

### PLEASE NOTE

Wood is a natural product and is therefore prone to changes in appearance, including some warping, movement and splitting, particularly during unusual climatic conditions (long hot or wet spells of weather). As a natural occurrence this is not covered by a guarantee.

**IMPORTANT!**  
 The only parts that require cutting are the angled eaves edgings , final roof and floor boards and the skirting.  
DO NOT CUT ANYTHING ELSE

**IMPORTANT SAFETY INFORMATION**

- We recommend the wearing of non-slip protective gloves throughout the assembly process. We also recommend the wearing of steel capped protective shoes, protective head gear, safety glasses and full length clothing. If step ladders are to be used we recommend one person holds the ladder whilst the other is using them. If necessary a third person should be used. Do not attempt to erect the building in windy conditions. Follow any safety precautions quoted by the manufacturer for any equipment you use.
- Every precaution has been taken to ensure that your building has no element incorrectly placed or possibly hazardous. However prior to use please check for raised grain or splinters and sand if necessary. Check that all elements are secure against reasonable force.

**A Windows– Inc frame assembly**

1. Refer to the two window drawing pages and to letter codes in contents table. The **WT** and **WD** parts will be at the top of the window frame.
2. To be sure you can lay all the pieces, including inserts together without fixing to familiarise yourself with the assembly.
3. Make sure the window insert fits inside the frame with a 5mm gap all around.
4. Lay out the parts **WA** and **WB** and **WT** as in the inner frame assembly drawing. The narrowest (25mm) edge to the work bench and the side the size is the same as the log thickness as shown in fig A1 . Part **WT** must be inside parts **WA** and part **WB** underneath the two **WA** parts (Fig A1 ) .
6. Pre drill 2 3mm holes at one end of the **WA** only and at both ends of the **WB** parts ( see drawing )and screw together at each corner,10mm in from the edge (ensuring each corner is flush) with 2x50mm screw (fig A1).

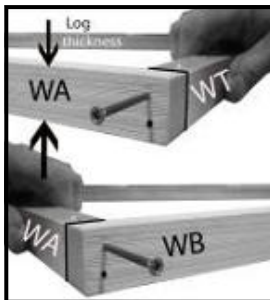

Fig A1

7. Measure and mark the centre of the frame (684mm from the outside fig A2 ) and position the **WM** piece (this is two pieces of wood already fixed side by side), Pre drill 2 3mm holes in the **WB** and **WT** parts and fix with 2x50mm screws at each end

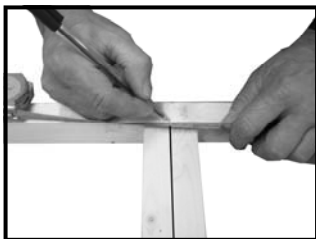

Fig A2

8. Layout parts **WC** ,**WD** , **WE** & **WJ** on top of the previous assembly as shown in the outer frame drawing.



Fig A3

9. Mark the first hole position 30mm from the end of part **WC** that is adjacent to the **WD** part , at the other end central to the **WB** part and then the between at approximately 260mm centres .
10. Note the **WC** , **WD** & **WE** pieces fitted to the opposite side must be drilled offset to this side to ensure the screws miss each other.
11. Place the other **WC** part underneath and drill through both pieces with a 3mm drill (fig A3).

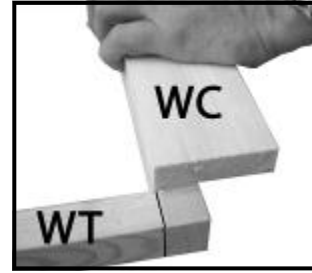

Fig A4

12. Place one of the **WC** parts on top of the **WA** part level with the inside of the frame and the bottom of the **WT** part (fig A4).
13. Fix to part **WC** to **WA** with 40mm screws ,spaced as before. (fig A5 & A6)
14. **important** fix at both ends first ensuring that they stay flush then the screws in between again ensuring that parts **WA** & **WC** are flush as you go.

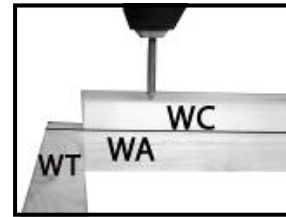

Fig A5

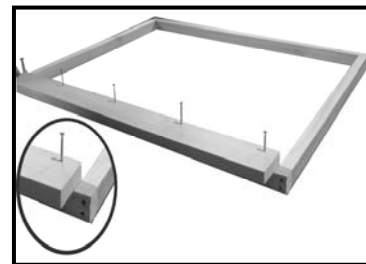

Fig A6

15. Place a **WD** part on top of a **WB** part. The **WD** part is positioned so there is an even overhang ( fig A7). Mark out and drill fix as before. But start at 100mm from the end of part **WD**.



Fig A7

16. Drill (not too deep) and screw in each corner with 40mm screws (fig A8).



Fig A8

17. With a pencil mark the screw centres on the inside long edge of the frame to help ensure the hinge screws will miss these screws.
18. Turn frame over and repeat on the other side fig A9 & A10).
19. **Note offset drilled holes from first side to ensure they miss each other first hole part **WC** =30mm part **WD** =100mm. LEAVE THE INNER SCREWS LOOSE SO YOU CAN REMOVE FRAME FROM THE BUILDING FOR PAINTING.**

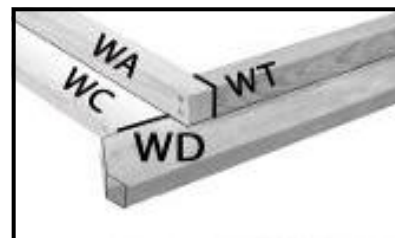

Fig A9



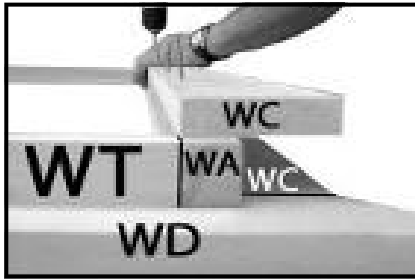

Fig A10.

20. **Window insert.** Place one hinge on the inner rebate part of the window; approx. One hinge width along from the rebate edge of the longest edge of the insert. The rounded part of the hinge should sit above the outer edge of the window. Screw the inner piece into position ( fig. A11 &A12 ) using the pre drilled holes in the hinge and 3 x 25mm screws. Repeat with the other hinge. And close the hinges together.

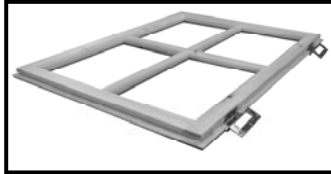

Fig A10- STYLE MAY VARY



Fig A11

21. Place the window into the aperture (fig A12 ) **ensure that part WC** is against the hinges .  
 22. Secure the window to the frame using 3x 25mm screws per hinge, (fig. A13 ) again through the predrilled holes in the hinge.  
 23. Repeat.

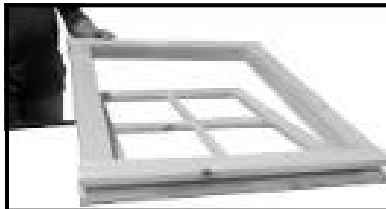

Fig A12

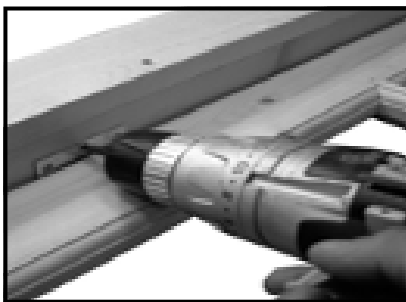
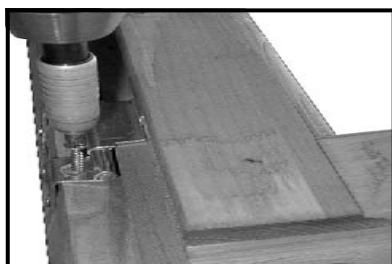

Fig A13

24. Open the window fully in order to fit a further 2x 25mm screws per hinge ( Fig. A14 ).



1 Fig A14

25. **Fitting the draught excluder. This must be done before fitting the casement stays and latches.**



Fig A15

26. Lay the assembled window unit with the opening insert downwards onto your work surface (Fig A15).  
 27. Position the draught strips so the rubber is against the opening insert and fix with 3x25mm oval nails per strip (Fig A15).  
 28. At the bottom of each window place a casement stay on top of the draught excluder strip. Visually judge the position of the stay so it looks central. Use a pin to judge how high to position the stay. Fix using 2 x 25mm screws (Fig A16).

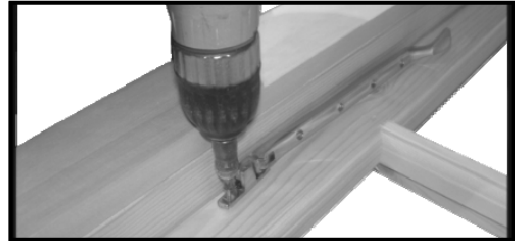

Fig A16

29. Stand the window up so it easier to fix the pins for the casement stays

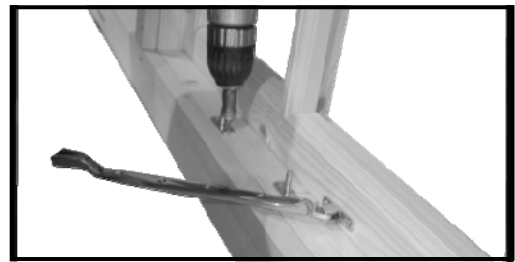

Fig A17

30. Position the first pin so it fits into the first hole on the stay making sure it holds the window tight. Carefully remove the stay holding the pin in position, secure pin using 2 x 25mm screws (Fig A17) . Repeat for other pins.

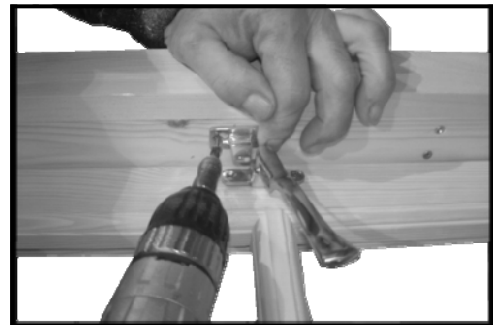

Fig A18

31. Along side one of the horizontal bars on the window insert place the side latch on top of the draught excluder (Fig A18).  
 32. Use the pin to correctly place the lever and secure using 2x25mm screws for each part (Fig A18).

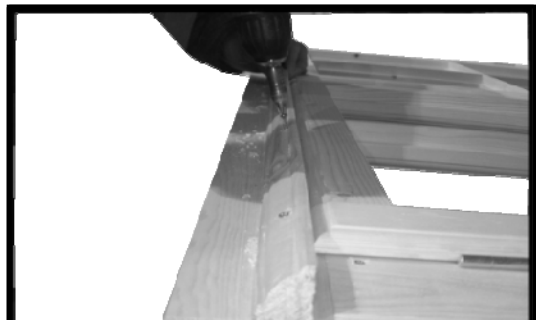

Fig A19

33. Fix the drip bar at the top of the window, there is a thin groove in one of the flat edges this needs to be facing the bottom of the building. Pre-drill seven holes and secure approx. 5mm above window inserts using 7 x 40mm screws.(figA19)

## B Floor bearers & first row of logs

See drawing pages 1 & 2 **THE BEARERS DO NOT REQUIRE CUTTING**

Read the Following the instructions below fully and study the drawing pages before you assemble your building up to and including the gables  
The terrace is assembled after the main building is assembled.

1. Use the contents list to identify all the bearer lengths. Due to supply issues some bearers may be joined to make the total length. Place a joiner next to the bearers and fix as in step 2.
2. Both the outer bearers and the ones where the joined floor boards meet are two bearers that sit side by side, nail these together at a slight angle with 75mm nails at approximately 300mm centres for each pair of bearers (fig B1).



Fig B1

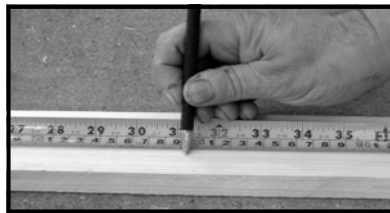

Fig B2

3. Take the half height log (A1) that sit on the bearers and you see the bearer ends and mark the floor bearer centres, but not the two pairs of outer bearers, from one end (fig B2 & drawing page).

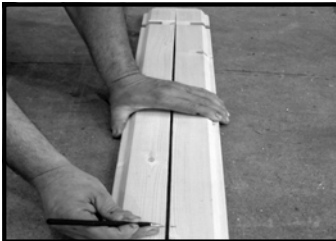

Fig B3

3. Place the 'A1' logs against each other and transfer all the lines across (fig B3).
4. The bearers stand with the narrowest edge to the floor (fig B4) and their ends 5mm back from the A1 logs face (Level with the chamfer).

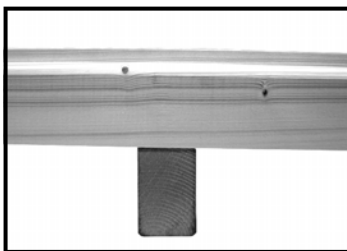

Fig B4

5. Assemble the first row of logs on top of the bearers by placing the half height (A1) logs in position and then the first of the logs (B) from each wall that run parallel to the bearers on top of them. (See drawing page 1). DO NOT FIX YET.
6. (See section C4).
7. **The logs are assembled with the tongues upwards**
8. Position the outer bearers so the outer log sits 5mm in from the outer face (fig B5 & DRAWING PAGE 1 FIG 2&3) of the side and front logs.

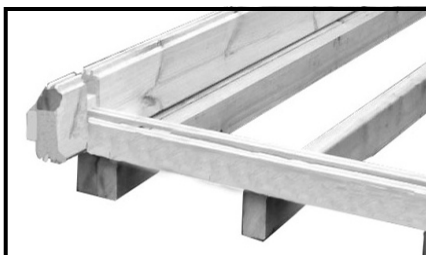

Fig B5

8. Cut notches out of the tongues on the A1 logs (fig B7) at centre marks (previous steps) and drill through for fixing to the bearers.
9. **Important**
10. Measure corner to corner, as building must be square
11. Also measure length at the centre of the building from wall to wall (A1 to A1) to ensure correct length before fixing to joists with 1x 80mm screw (fig B6 & B7) at each bearer. Also position some floorboards to check spacing is correct to the joins.

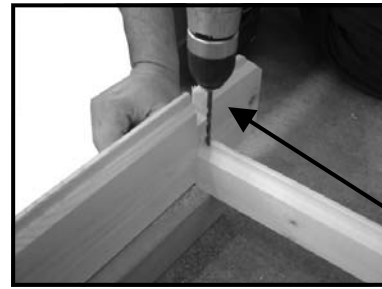

Fig B6



Fig B7

12. This is the bottom of all four walls now ready to be built upon.

## C Walls

See drawing pages

1. Using parts list for each wall layout correct quantity (fig C1) of each component for relevant wall (i.e. front, back) in suitable position for ease of assembly.

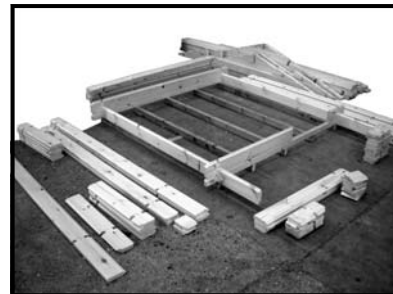
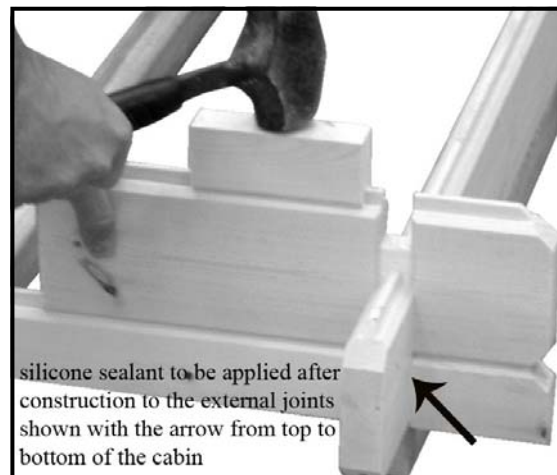

Fig C1-example

2. The walls can now be assembled as per drawing pages above. Start building walls by placing all the logs from front to back and then from side to side
3. **The logs are assembled with the tongues upwards**
4. Each log needs to be tapped home to log below using timber block supplied and a rubber mallet (C2).



silicone sealant to be applied after construction to the external joints shown with the arrow from top to bottom of the cabin

Fig C2

## D Inserting windows and doors

**UNDER NO CIRCUMSTANCES MUST THE DOOR OR WINDOW FRAMES BE NAILED TO THE LOGS .The logs must be free to move within the frame lots to allow for expansion and contraction.**

### **AS SOON AS YOU FIT DOOR UNIT FIT HANDLES AND UNLOCK DOOR**

1. Door unit must be placed into position after the first two layers of full logs have been assembled
2. Slide unit into aperture from above (Fig D1 & D2) ensuring unit is completely down and in position.



Fig D1 EXAMPLE



Fig D2

3. Window units are fitted as above (fig D38) when you have built up to the correct height



Fig D3 example

4. **Note** Door and window units do not require fixing to the logs
5. Once the door and window units are in place continue assembling the walls as before but slide the logs into the door or window frame (fig D4) from above then tap them down.



Fig D4

6. Continue building until you get to the height where the gable starts.

## E Gables

See drawing pages 3 & 5

1. Assemble the gables as with the walls.
2. Once gables are in place knock down all the walls again as in fig C2 to ensure all the walls are fully home
3. Fix the gable with 1x80mm screw at each end (fig E1) and as shown on the drawing pages (Some screws may go into roof joists)

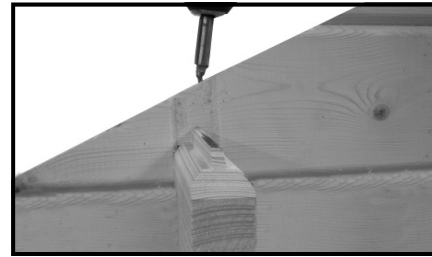

Fig E1

## F Roof joists

1. Fit roof joists into slots provided in the gable sections (fig F1 & F2).



Fig F1

2. Measure the distance between each roof joist and the roof joist and walls to ensure all components are fully home before continuing.



Fig F2 example

## G Roof boards

1. There are eaves edging strips for the building (2 places) (These may need cutting to fit).
2. Position the eaves edging strips (fig G1 & G2) level at both ends with the gable angle and screw to the wall with 50mm screws at approximately 400 centres.



Fig G1



Fig G2

3. The first roof board is now ready to be positioned (fig G3) **Bevel edge downwards.** (flat surface where the tiles are fixed)
4. **NOTE** only the final boards need trimming.

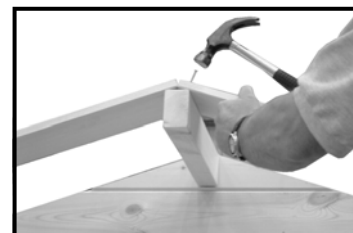

Fig G3

5. Start at the front, place the board level with the end of the roof bearers and central over the middle bearer to produce an even overhang (fig G3).
6. Fix into place at the roof bearers and angled eaves edgings using two 40mm ROUND HEAD nails at each bearer & eaves edging



Fig G4

7. The final roof board will need to be cut. Place it in position and measure the distance between the end of the roof bearers and the edge of the board. This will tell you how much you need to cut off (fig G4).
8. Next fit the roof edgings to the outer edges of the roof boards with 50 mm screws at approximately 300mm centres (Fig. G5).

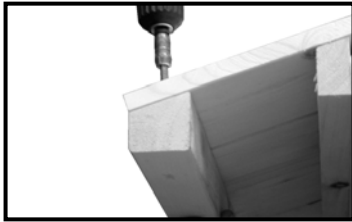

Fig G5

9. Fit the 19x70mm eaves edgings onto the roof edgings. Place a floor board on top of and over the edge of the roof as a guide and place the top of the roof edging level with this (fig G6) and fix with 40mm screws at 400mm spacing's.

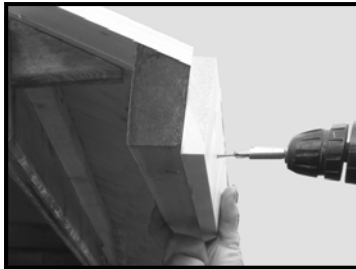

Fig G6

## H Tile Roof March 2012 onwards

1. Packs of shaped tiles which are used for the slope, eaves (low edge) and ridge (top point) have been supplied. (SEE CONTENTS)
2. Use tiles randomly from the packs of tiles supplied to even out the colour match. **REMOVE BACKING FROM ALL TILES**
3. **remove all dust and sharp edges from the roof boards.**  
**If you are fitting your own guttering fit it now so you can over lap the eaves tiles into the gutter.**

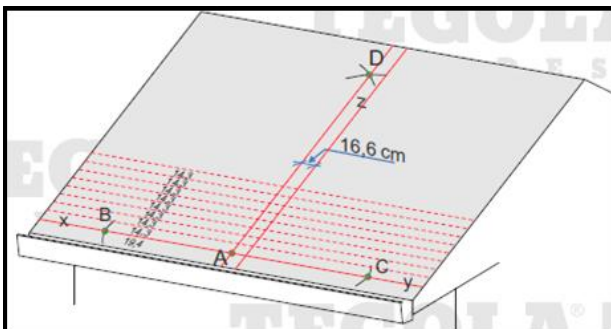

Fig H1

5. Mark a line xy orthogonal to the direction of maximum slope of the roof (usually parallel to the eaves and to the ridge and at 18.4 cm from the eaves to give a 1 cm drip edge);
6. Mark along the line xy a point A in the centre of the pitch;
7. Mark points B e C, at either side from A (for example at 150 cm);
8. Starting from B and C by using a chalk line as a compass, mark point D as near as possible to the Ridge.
9. Join A with D;
10. Mark a line parallel to line AD at a distance of 16,6 cm (z);
11. Starting from the line xy, mark horizontal and parallel lines to the line xy, at a distance of 14,3 cm from each other up to the ridge (Fig H 11)



Fig H2

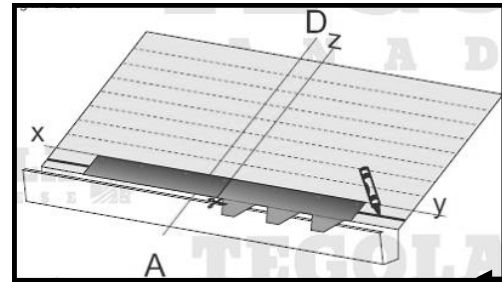

Fig H3

12. Trim the tabs from the bituminous shingle, remove the protection film to form the starter course (Fig H2 & 3)
13. Align it to the line z & xy (Fig H3).
14. Remove the protection film from the reverse side of each shingle before installation.

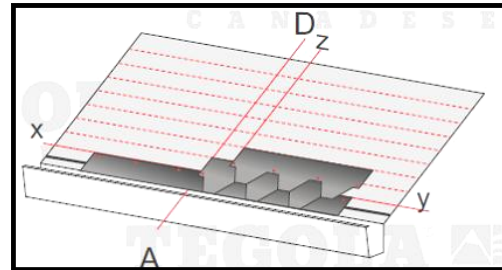

Fig H4

15. Install the first row of shingles along the line AD (Fig H4).

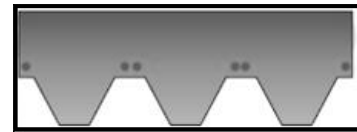

Fig H5

16. Apply 6 nails on each bituminous shingle, positioned exactly as shown in fig 5
17. Make sure that the nails anchor also the underneath bituminous shingle. Install the second row of shingles along the line z (Fig H 4)
18. Repeat this installation method until all pitches are completed
19. The trimming and aligning operations are simplified following the cuts on the upper edge of each bituminous shingle.

### RIDGE

20. Install the last row of bituminous shingles up to the ridge line and then bend it over the exceeding part, in order to waterproof the ridge.
21. To obtain the ridges, cut the bituminous shingles into 3 pieces (Fig H 6). Before installing remove the rivers side protection film, bend the piece of shingle and position them over the ridge line (see Picture)
22. If necessary heat them on the reverse, sanded side.
23. Fix the ridges with 2 nails on each piece which will be overlapped by the following piece (Fig H7).

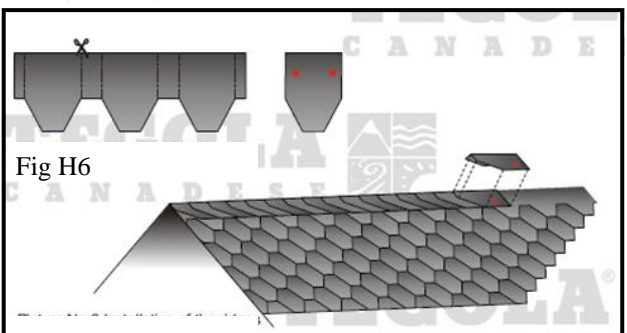

Fig H6

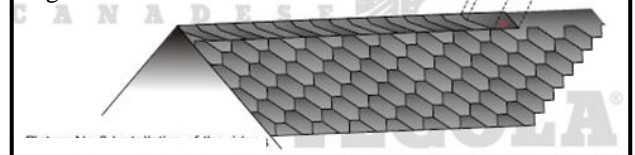

Fig H7



## I Fascia

1. Fascia boards can now be drilled and screwed ( fig I1 ) with 1x 50mm screw at each roof bearer and the roof edgings.



Fig I1

2. Drill diamond and screw with 2x50mm screws . (fig I2)

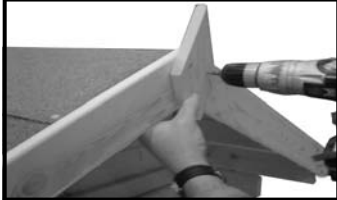

Fig I2

## J Floor

1. The floor is fitted working from front to back with 40mm nails
2. Position the first floorboard under the doorframe (Fig J1), with the **groove against the wall the bevel edge downwards**.



Fig J1

3. Fix into position with two nails at each floor bearer (Fig J2& J3).



Fig J2

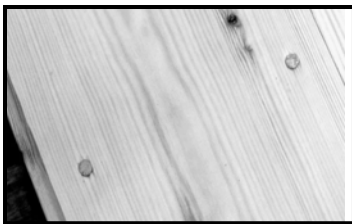

Fig J3

4. Continue with remaining floorboards until you have three remaining.
5. Place these in position without nailing them down, as the last floorboard will require trimming.
6. Measure the distance between the last full board and the wall (Fig J4). This measurement is then marked on the final board and then cut to fit , **leaving the groove on the board**.

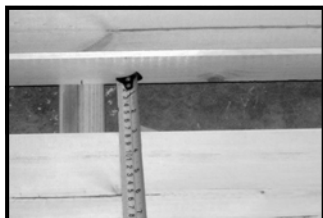

Fig J4

7. Curl the boards up ( fig J5 ) to put it into position and nail the remaining boards as before



Fig J5

8. Cut the skirting boards to suit and fix with 40mm oval nails at approx 400mm centres (fig J6)



Fig J6

## K Terrace – assemble after main building is finished

1. Space the floor bearers as shown in the drawing pages, with the 63mm ( widest ) side to the floor and the outer bearers level with the walls (Fig K1) **Set the bearer spacing with the deck boards to ensure the joins are in the centre of the bearers**. The deck walls sit on top of the decking.



Fig K1

2. Equally space the decking boards leaving an even gap between each board ,check that the deck is square and screw into position using 40mm screws (Fig K2 – K4)



Fig K2



Fig K3



Fig K4

- Place the first row of logs into position (drawings), measure diagonally to ensure the logs are square and parallel before screwing into position ( as with the first row of building logs )with 80mm screws (Fig K5 –K7)



Fig K5

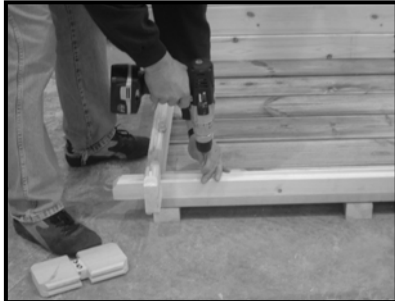

Fig K6



Fig K7

- You are now ready to assemble the rest of the logs (Drawings & Fig K8)



Fig K8

- Next four parts V13 (One inside and one outside at each join) are used to join the veranda to the building (Fig K9) with 2 columns of four 40mm screws per V13.



Fig K9

- Next position all the capping pieces (v11 front cap x2, v12 corner caps x4 & v14 side caps ) on top of the terrace.
- Once you are happy with the positions you can fix them into place.
- V11 & V14 into position (Fig K10) secure with 3 x 40mm screws each.
- V12 corner caps secure with 4 x 60mm screws each.



Fig K10



Fig K11

- (Fig K12) Shows the completed terrace.



Fig K12

**L Glazing**  **Danger of cutting use gloves ect.**

#### After painting

- NOTE** ensure that you have treated the beading and the rebate where the glass fits before fixing the glazing.
- Place glazing material into the aperture of each window.
- Hold into position with four pieces of beading . The beading may need to be swapped around to get the best fit. When satisfied secure into position using 2x15mm panel pins per piece of beading. ( fig L1 )Repeat for all window and door apertures.



Fig L1

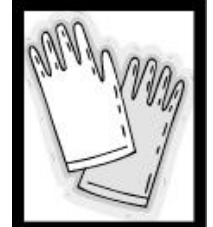

## Assembly Completion Checklist

**1** Check and ensure that no raised grain or splinters are evident on timber components. Sand down any raised grain or splinters using fine grade sandpaper.

**2** Check that all screw, nail and pin heads are properly tapped home and are not proud of the timber surface.

**3** Check and ensure that no screws, nails or pins protrude through any panel.

**4** Check and ensure that all parts are properly

secured against reasonable force.

**5** Do not apply decorative wood finish/treatments to wet or damp timber. Please observe the instructions of the wood finish/treatment manufacturer.

# SHIRE

BUILT AROUND OUR REPUTATION

## page 1

fig 1

# Base details & Floor bearer layout

see page 2 for spacing

- 4190 X 4190(5690)  
34mm log  
FLOOR PLAN
- Floor bearers 15 x 3890  
**OR**
- 30off to make above length  
and Joiners
- Joiners 11 x approx 0.5-1m
- Floorboards 36 x 3270 36 x 660
- TERRACE FLOOR
- Deck bearers 11x1500
- Deck boards 12x2390  
12x1600

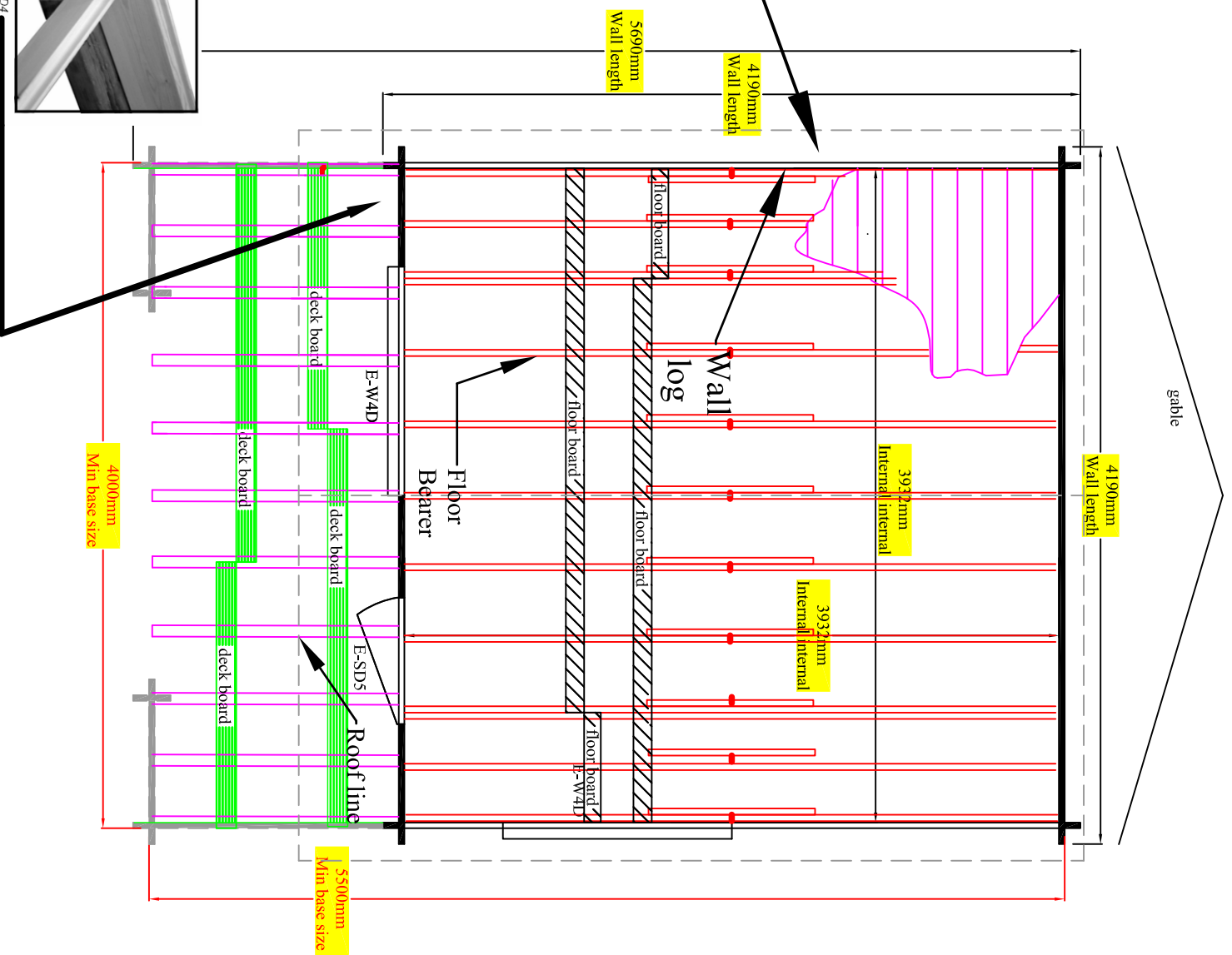
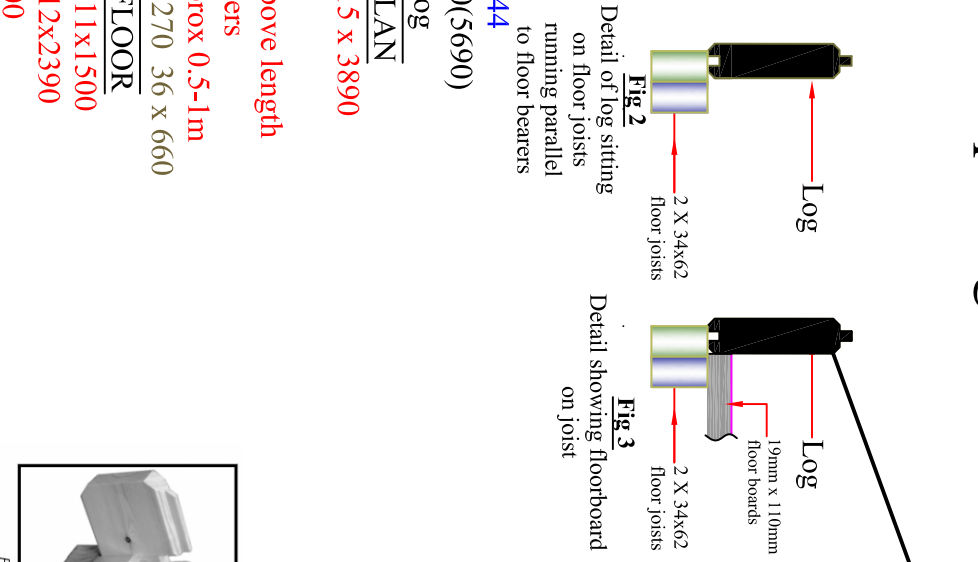

# Front view

# SHIRE

BUILT AROUND OUR REPUTATION

## page 2

Kinver 44

4190 X 4190(5690)

34mm log

FRONT

Parts list

A1 x 1

A2 x 1

C x 8

C1 x 1

D x 25

E x 8

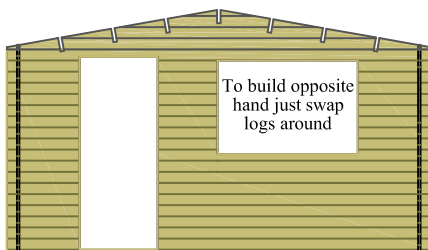
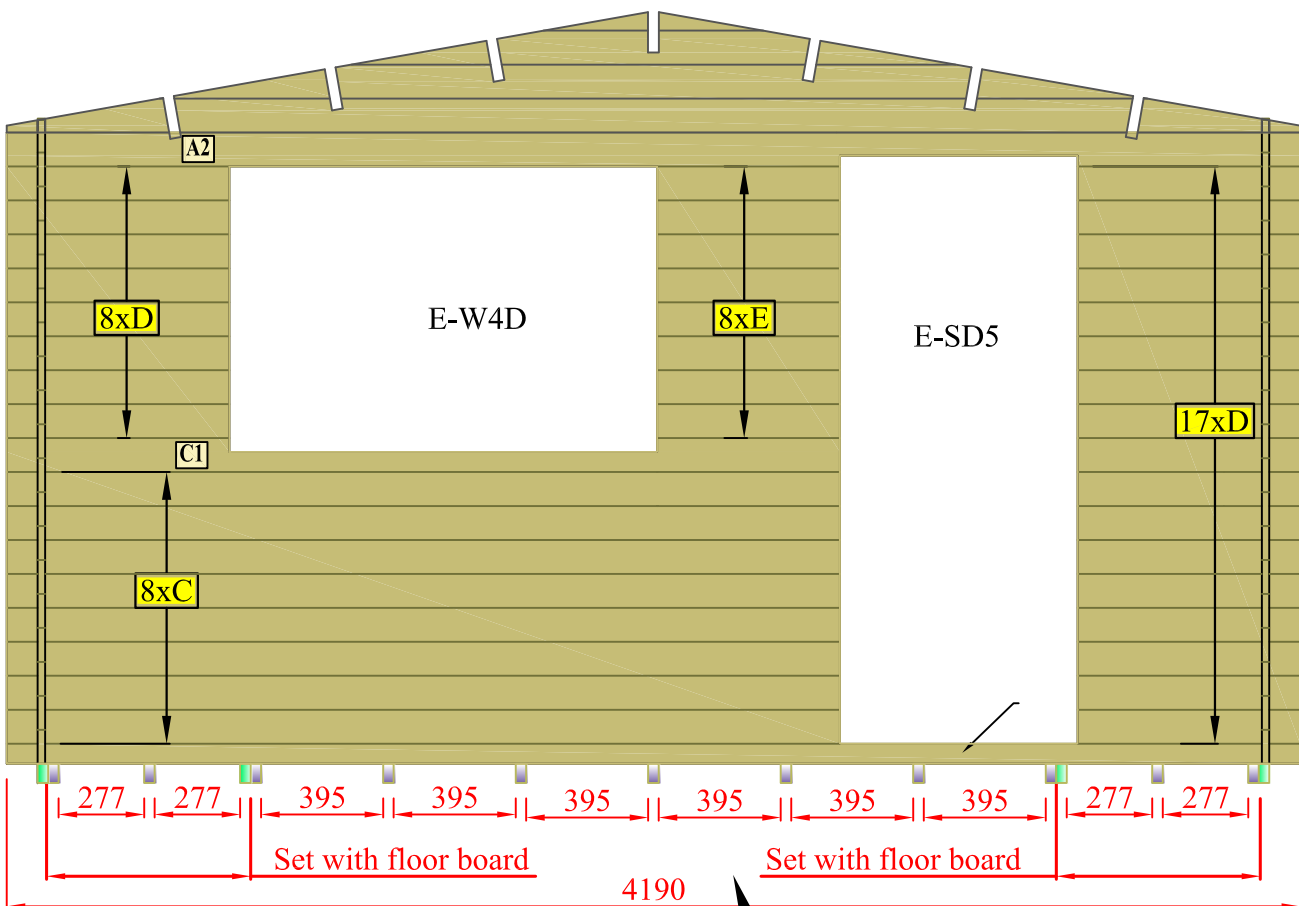

Bearer spacing



# Back View

Kinver 44

4190 X 4190(5690)

34mm log

BACK

Parts list

A x 18

A1 x 1

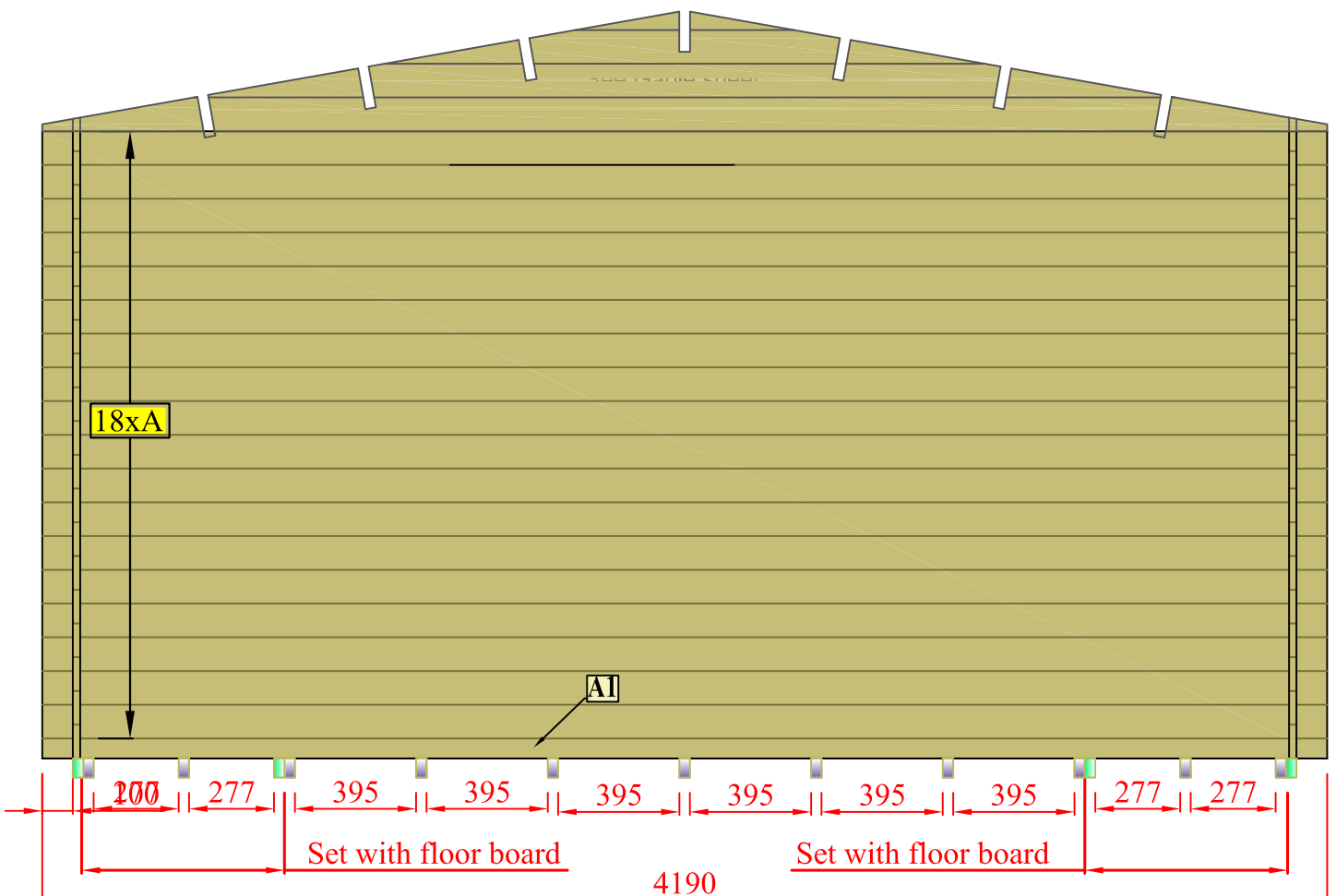

# SHIRE

BUILT AROUND OUR REPUTATION

page 4

## LH side view

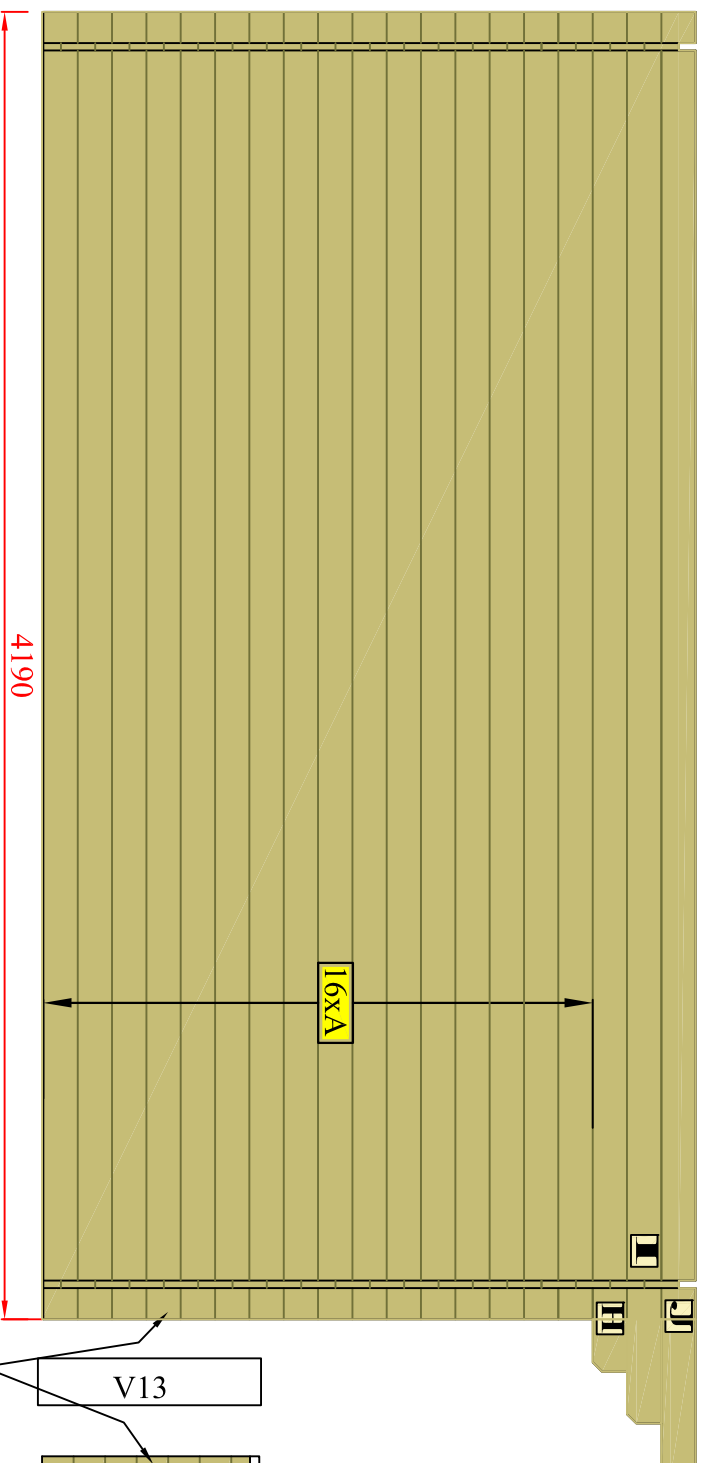

**Kinver 44**  
4190 X 4190(5690)

34mm log

LH SIDE

Parts list

A x 16

H x 1

I x 1

J x 1

Terrace

V1x3

V1tx1

V3x3

V6x3

capping

v14

joiners

v13x2

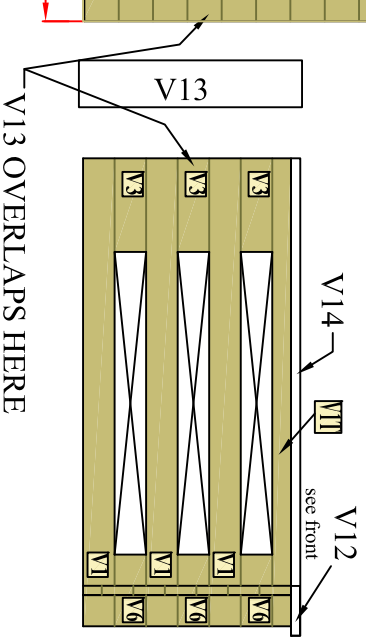

mm

**Kinver 44**  
4190 X 4190(5690)

34mm log

RH SIDE

Parts list

A x 9

A3 x 1

D x 6

F x 7

I1 x 1

J x 1

K x 1

Terrace

V1x3

V1tx1

V3x3

V6x3

capping

v14

joiners

v13x2

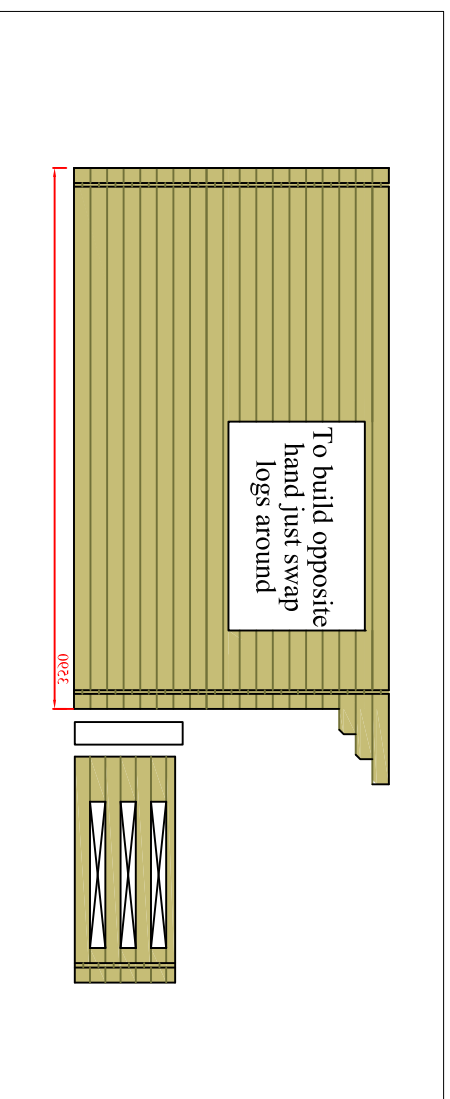

# RH Side view

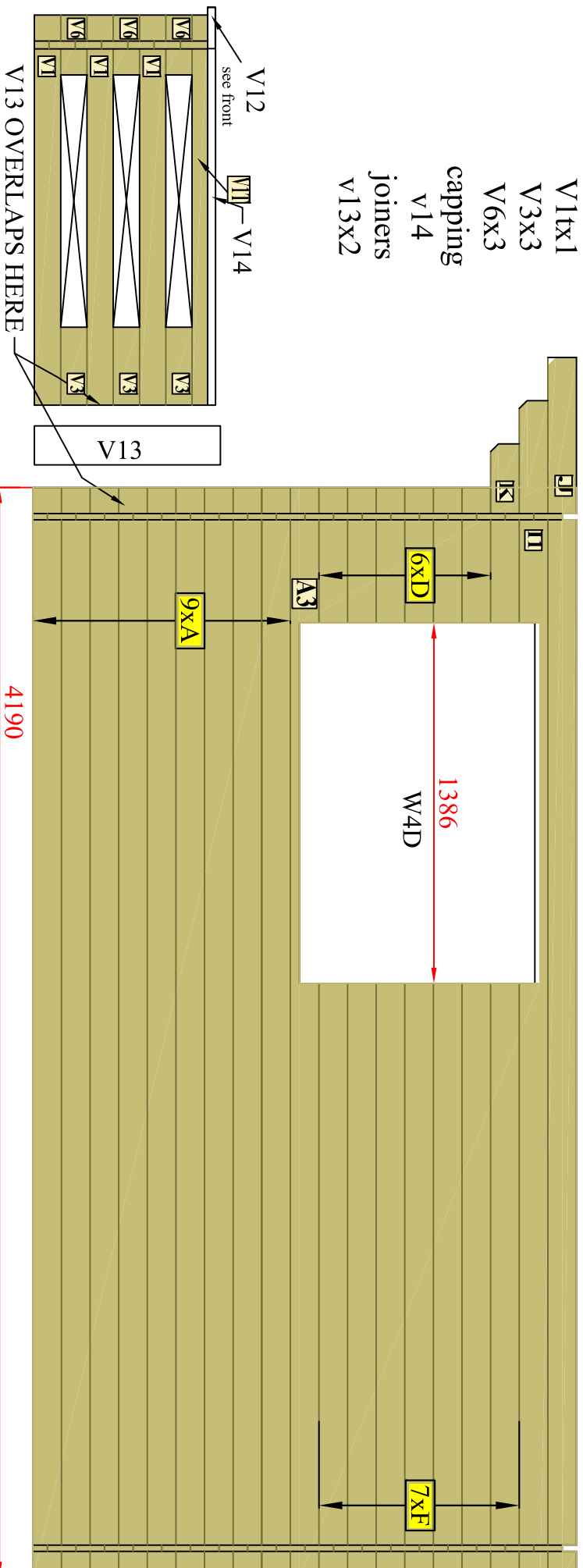

**SHIRE**  
BUILT AROUND OUR REPUTATION

pages

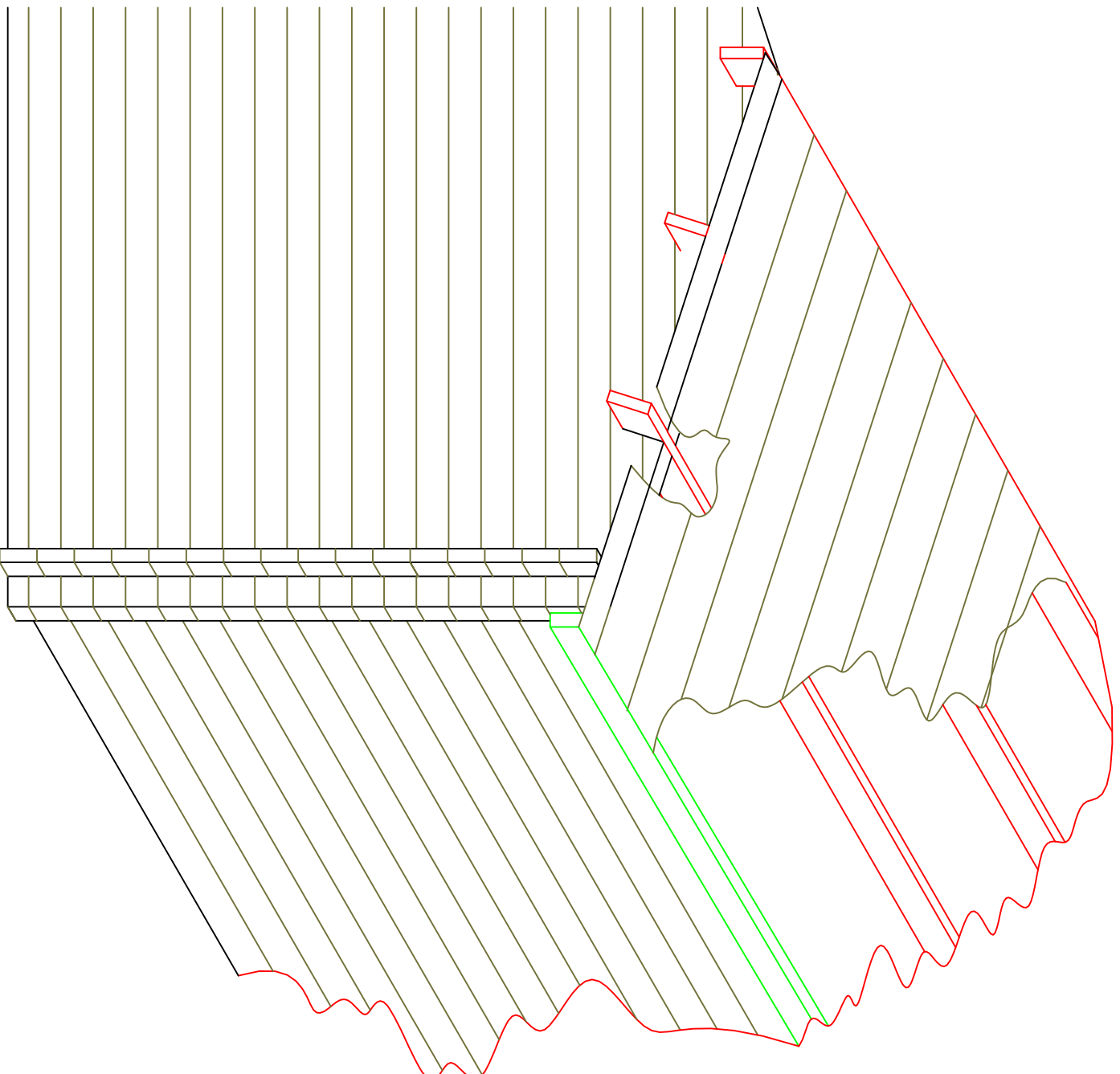

**Kinver 44**  
4190 X 4190(5690)

34mm log

ROOF ASSY

Parts list

**7 Roof bearers**

**2 Angled eaves**  
edging strips

**2 Angled roof edgings**

86 Roof boards

2236 long

# Terrace front

Kinver 44  
4190 X 4190(5690)

**SHIRE**  
BUILT AROUND OUR REPUTATION

## TERRACE

### PARTS LIST

- V2b x 2
- V2 x4
- V2t x 2
- V6 x24
- V6t X 2
- Capping
- V11 X 2
- V12 X 4

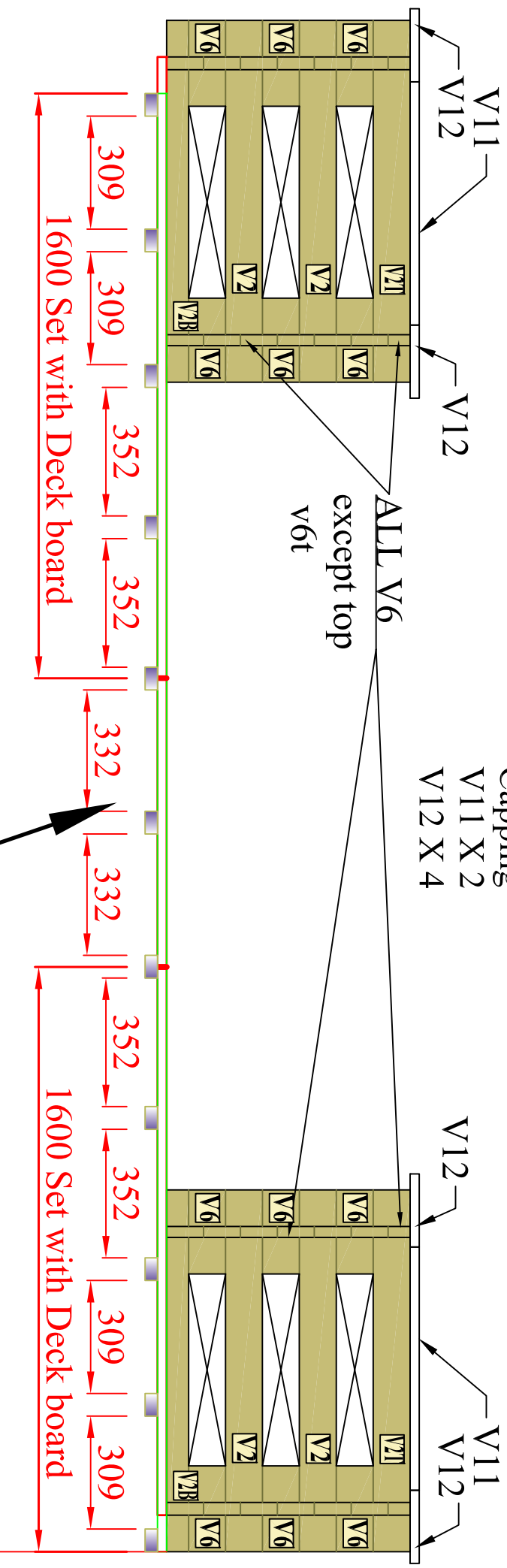

# Bearer spacing