

# Erbauer®



**ERB383WCH**

**2Year**  
Guarantee

**1500W WALL CHASER**

Original Instructions  
(Version 2.0)

# Erbauer®

**Congratulations on your purchase of a quality power tool from Erbauer (UK) Ltd. This product should give you reliable service but for your peace of mind this **Erbauer** power tool does carry a 2 year guarantee, the terms of which are detailed below.**

**If this product develops a fault within the guarantee period contact your retailer.**

**Please retain this handbook in case you need to refer to safety, care or guarantee information in the future.**

## **GUARANTEE**

This **Erbauer** product carries a 2 year guarantee. If your product develops a fault within this period, you should in the first instance contact the retailer where the item was purchased.

This guarantee specifically excludes losses caused due to:

- Fair wear and tear
- Misuse or abuse
- Lack of routine maintenance
- Failure of consumable items (such as batteries)
- Accidental damage
- Cosmetic damage
- Failure to follow manufacturer's guidelines
- Loss of use of the goods

This guarantee does not affect your statutory rights. This guarantee is only valid in the UK.

For further technical advice, spare parts or repair service (outside of guarantee) please contact the customer helpline number on 0845 607 6380.

# 1500W WALL CHASER

# GENERAL POWER TOOL SAFETY WARNINGS



**WARNING! Read all safety warnings and all instructions.** Failure to follow the warnings and instructions may result in electric shock, fire and/or serious injury.

**Save all warnings and instructions for future reference.**

The term “power tool” in the warnings refers to your mains-operated (corded) power tool or battery-operated (cordless) power tool.

## 1. Work area safety

**a) Keep work area clean and well lit.** Cluttered or dark areas invite accidents.

**b) Do not operate power tools in explosive atmospheres, such as in the presence of flammable liquids, gases or dust.** Power tools create sparks which may ignite the dust or fumes.

**c) Keep children and bystanders away while operating a power tool.** Distractions can cause you to lose control.

## 2. Electrical safety

**a) Power tool plugs must match the outlet. Never modify the plug in any way. Do not use any adapter plugs with earthed (grounded) power tools.** Unmodified plugs and matching outlets will reduce risk of electric shock.

**b) Avoid body contact with earthed or grounded surfaces, such as pipes, radiators, ranges and refrigerators.** There is an increased risk of electric shock if your body is earthed or grounded.

**c) Do not expose power tools to rain or wet conditions.** Water entering a power tool will increase the risk of electric shock.

**d) Do not abuse the cord. Never use the cord for carrying, pulling or unplugging the power tool. Keep cord away from heat, oil, sharp edges or moving parts.** Damaged or entangled cords increase the risk of electric shock.

**e) When operating a power tool outdoors, use an extension cord suitable for outdoor use.** Use of a cord suitable for outdoor use reduces the risk of electric shock.

**f) If operating a power tool in a damp location is unavoidable, use a residual current device (RCD) protected supply.** Use of an RCD reduces the risk of electric shock.

## 3. Personal safety

**a) Stay alert, watch what you are doing and use common sense when operating a power tool. Do not use a power tool while you are tired or under the influence of drugs, alcohol or medication.** A moment of inattention while operating power tools may result in serious personal injury.

**b) Use personal protective equipment. Always wear eye protection.** Protective equipment such as dust mask, non-skid safety shoes, hard hat, or hearing protection used for appropriate conditions will reduce personal injuries.

**c) Prevent unintentional starting. Ensure the switch is in the off-position before connecting to power source and/or battery pack, picking up or carrying the tool.** Carrying power tools with your finger on the switch or energising power tools that have the switch on invites accidents.

**d) Remove any adjusting key or wrench before turning the power tool on.**

A wrench or a key left attached to a rotating part of the power tool may result in personal injury.

**e) Do not overreach. Keep proper footing and balance at all times.** This enables better control of the power tool in unexpected situations.

**f) Dress properly. Do not wear loose clothing or jewellery. Keep your hair, clothing and gloves away from moving parts.** Loose clothes, jewellery or long hair can be caught in moving parts.  
**g) If devices are provided for the connection of dust extraction and collection facilities, ensure these are connected and properly used.** Use of dust collection can reduce dust-related hazards.

#### 4. Power tool use and care

**a) Do not force the power tool.** Use the correct power tool for your application. The correct power tool will do the job better and safer at the rate for which it was designed.

**b) Do not use the power tool if the switch does not turn it on and off.** Any power tool that cannot be controlled with the switch is dangerous and must be repaired.

**c) Disconnect the plug from the power source and/or the battery pack from the power tool before making any adjustments, changing accessories, or storing power tools.** Such preventive safety measures reduce the risk of starting the power tool accidentally.

**d) Store idle power tools out of the reach of children and do not allow persons unfamiliar with the power tool or these instructions to operate the power tool.**

Power tools are dangerous in the hands of untrained users.

**e) Maintain power tools. Check for misalignment or binding of moving parts, breakage of parts and any other condition that may affect the power tool's operation. If damaged, have the power tool repaired before use.** Many accidents are caused by poorly maintained power tools.

**f) Keep cutting tools sharp and clean.** Properly maintained cutting tools with sharp cutting edges are less likely to bind and are easier to control.

**g) Use the power tool, accessories and tool bits etc. in accordance with these instructions, taking into account the working conditions and the work to be performed.** Use of the power tool for operations different from those intended could result in a hazardous situation.

#### 5. Service

**a) Have your power tool serviced by a qualified repair person using only identical replacement parts.** This will ensure that the safety of the power tool is maintained.

**b) If the replacement of the supply cord is necessary, this has to be done by the manufacturer or his agent in order to avoid a safety hazard.**

# 1500W WALL CHASER

## **ADDITIONAL SAFETY RULES FOR YOUR WALL CHASER**

- a) **The guard provided with the tool must be securely attached to the power tool and positioned for maximum safety, so the least amount of wheel is exposed towards the operator. Position yourself and bystanders away from the plane of the rotating wheel.** The guard helps to protect operator from broken wheel fragments and accidental contact with wheel.
- b) **Use only bonded reinforced or diamond cut-off wheels for your power tool.** Just because an accessory can be attached to your power tool, it does not assure safe operation.
- c) **The rated speed of the accessory must be at least equal to the maximum speed marked on the power tool.** Accessories running faster than their rated speed can break and fly apart.
- d) **Wheels must be used only for recommended applications. For example: do not grind with the side of cut-off wheel.** Abrasive cut-off wheels are intended for peripheral grinding, side forces applied to these wheels may cause them to shatter.
- e) **Always use undamaged wheel flanges that are of correct diameter for your selected wheel.** Proper wheel flanges support the wheel thus reducing the possibility of wheel breakage.
- f) **Do not use worn down reinforced wheels from larger power tools.** Wheels intended for a larger power tool are not suitable for the higher speed of a smaller tool and may burst.
- g) **The outside diameter and the thickness of your accessory must be within the capacity rating of your power tool.** Incorrectly sized accessories cannot be adequately guarded or controlled.
- h) **The arbour size of wheels and flanges must properly fit the spindle of the power tool.** Wheels and flanges with arbour holes that do not match the mounting hardware of the power tool will run out of balance, vibrate excessively and may cause loss of control.
- i) **Do not use damaged wheels. Before each use, inspect the wheels for chips and cracks. If power tool or wheel is dropped, inspect for damage or install an undamaged wheel. After inspecting and installing the wheel, position yourself and bystanders away from the plane of the rotating wheel and run the power tool at maximum no load speed for one minute.** Damaged wheels will normally break apart during this test time.
- j) **Wear personal protective equipment. Depending on application, use face shield, safety goggles or safety glasses. As appropriate, wear dust mask, hearing protectors, gloves and shop apron capable of stopping small abrasive or workpiece fragments.** The eye protection must be capable of stopping flying debris generated by various operations. The dust mask or respirator must be capable of filtering particles generated by your operation. Prolonged exposure to high intensity noise may cause hearing loss.
- k) **Keep bystanders a safe distance away from work area. Anyone entering the work area must wear personal protective equipment.** Fragments of workpiece or of a broken wheel may fly away and cause injury beyond immediate area of operation.
- l) **Hold the power tool by insulated gripping surfaces only, when performing an operation where the cutting accessory may contact hidden wiring or its own cord.** Cutting accessory contacting a "live" wire may make exposed metal parts of the power tool "live" and could give the operator an electric shock.
- m) **Position the cord clear of the spinning accessory.** If you lose control, the cord may be cut or snagged and your hand or arm may be pulled into the spinning wheel.
- n) **Never lay the power tool down until the accessory has come to a complete stop.**

The spinning wheel may grab the surface and pull the power tool out of your control.

- o) Do not run the power tool while carrying it at your side.** Accidental contact with the spinning accessory could snag your clothing, pulling the accessory into your body.
- p) Regularly clean the power tool's air vents.** The motor's fan will draw the dust inside the housing and excessive accumulation of powdered metal may cause electrical hazards.
- q) Do not operate the power tool near flammable materials.** Sparks could ignite these materials.
- r) Do not use accessories that require liquid coolants.** Using water or other liquid coolants may result in electrocution or shock.

### **Kickback and related warnings**

Kickback is a sudden reaction to a pinched or snagged rotating wheel. Pinching or snagging causes rapid stalling of the rotating wheel which in turn causes the uncontrolled power tool to be forced in the direction opposite of the wheel's rotation at the point of the binding.

For example, if an abrasive wheel is snagged or pinched by the workpiece, the edge of the wheel that is entering into the pinch point can dig into the surface of the material causing the wheel to climb out or kick out. The wheel may either jump toward or away from the operator, depending on direction of the wheel's movement at the point of pinching. Abrasive wheels may also break under these conditions.

Kickback is the result of power tool misuse and/or incorrect operating procedures or conditions and can be avoided by taking proper precautions as given below.

- a) Maintain a firm grip on the power tool and position your body and arm to allow you to resist kickback forces. Always use auxiliary handle, if provided, for maximum control over kickback or torque reaction during start-up.** The operator can control torque reactions or kickback forces, if proper precautions are taken.
- b) Never place your hand near the rotating accessory.** Accessory may kickback over your hand.
- c) Do not position your body in line with the rotating wheel.** Kickback will propel the tool in direction opposite to the wheel's movement at the point of snagging.
- d) Use special care when working corners, sharp edges etc. Avoid bouncing and snagging the accessory.** Corners, sharp edges or bouncing have a tendency to snag the rotating accessory and cause loss of control or kickback.
- e) Do not attach a saw chain, woodcarving blade, segmented diamond wheel with a peripheral gap greater than 10 mm or toothed saw blade.** Such blades create frequent kickback and loss of control.
- f) Do not "jam" the wheel or apply excessive pressure. Do not attempt to make an excessive depth of cut.** Overstressing the wheel increases the loading and susceptibility to twisting or binding of the wheel in the cut and the possibility of kickback or wheel breakage.
- g) When wheel is binding or when interrupting a cut for any reason, switch off the power tool and hold the power tool motionless until the wheel comes to a complete stop. Never attempt to remove the wheel from the cut while the wheel is in motion otherwise kickback may occur.** Investigate and take corrective action to eliminate the cause of wheel binding.
- h) Do not restart the cutting operation in the workpiece. Let the wheel reach full speed and carefully re-enter the cut.** The wheel may bind, walk up or kickback if the power tool is restarted in the workpiece.
- i) Support panels or any oversized workpiece to minimize the risk of wheel pinching and kickback.** Large workpieces tend to sag under their own weight. Supports must be placed under the workpiece near the line of cut and near the edge of the workpiece on both sides of the wheel.

# 1500W WALL CHASER

- j) **Use extra caution when making a “pocket cut” into existing walls or other blind areas.** The protruding wheel may cut gas or water pipes, electrical wiring or objects that can cause kickback.

## **ADDITIONAL SAFETY RULES:**

1. **Always wear a dust mask.**
2. **Always wear safety glasses or eye shields when using the WALL CHASER** Everyday eyeglasses have only impact-resistant lenses; they are NOT safety glasses. Following this rule will reduce the risk of serious personal injury.
3. **Always wear hearing protection during extended periods of operation.** Following this rule will reduce the risk of serious personal injury.
4. **Keep your hands away from cutting area.** Do not reach under the material being cut because the nearness of the blade to your hand is hidden from your sight.
5. **Do not use dull or damaged blades.** Bent blades can break easily, or cause kickback.
6. **Remove the plug from the socket before carrying out any adjustment, servicing or maintenance.**
7. **Fully unwind cable drum extensions to avoid potential overheating.**
8. **When an extension cable is required you must ensure it has the correct ampere rating for your power tool and is in a safe electrical condition.**
9. **Ensure your mains supply voltage is the same as indicated on the rating plate.**
10. **Your tool is double insulated for additional protection against a possible electrical insulation failure within the tool.**
11. **Always check walls, floors and ceilings to avoid hidden power cables and pipes.**
12. **After long working period, external metal parts and accessories could be hot.**
13. **Only withdraw the blade from the cut when the blade has been stopped moving.**
14. **The pivoting blade foot must be held firmly against the material being cut to reduce saw vibration, blade jumping and blade breakage.**
15. **Before cutting, check the cutting line is free of nails, screws, etc.**
16. **If possible, ensure the work-piece is firmly clamped to prevent movement.**
17. **Never stop the cutting blade by applying side pressure to the blade.**



**Warning: Some dust particles created by power sawing, contain chemicals known to cause cancer, birth defects or other reproductive harm.** Some examples

of these chemicals are:

- Lead from lead-based paints.
- Crystalline silica from bricks and cement and other masonry products.
- Arsenic and chromium from chemically treated lumber.

Your risk from these exposures varies, depending upon how often you do this type of work. To reduce your exposure to these chemicals:

- Work in a well-ventilated area.
- Work with approved safety equipment, such as those dust masks that are specially designed to filter microscopic particles.



## VIBRATION

The European Physical Agents (Vibration) Directive has been brought in to help reduce hand arm vibration syndrome injuries to power tool users. The directive requires power tool manufacturers and suppliers to provide indicative vibration test results to enable users to make informed decisions as to the period of time a power tool can be used safely on a daily basis and the choice of tool.

Further Advice can be found at [www.hse.gov.uk](http://www.hse.gov.uk)

Vibration total values (triax vector sum) determined according to EN 60745:	
Typical weighted vibration	Vibration emission value $a_{hv}=6.53\text{m/s}^2$
	Uncertainty $K = 1.5\text{m/s}^2$

The declared vibration emission value should be used as a minimum level and should be used with the current guidance on vibration.

Calculating the actual period of the actual period off use can be difficult and the HSE website has further information.

The declared vibration emission been measured in accordance with a standardised test stated above and may be used to compare one tool with another tool.

The declared vibration emission value may also be used in a preliminary assessment of exposure.

 **Warning:** The vibration emission value during actual use of the power tool can differ from the declared value depending on the ways in which the tool is used dependant on the following examples and other variations on how the tool is used:-

How the tool is used and the materials being cut.

The tool being in good condition and well maintained.

The use the correct accessory for the tool and ensuring it is sharp and in good condition.

The tightness of the grip on the handles and if any anti vibration accessories are used.

And the tool is being used as intended by its design and these instructions.

**While working with this power tool, hand/arm vibrations occur. Adopt the correct working practices in order to reduce the exposure to vibration.**

**This tool may cause hand-arm vibration syndrome if its use is not adequately managed.**

 **Warning:** To be accurate, an estimation of exposure level in the actual conditions of use should also take account of all parts of the operating cycle such as the times when the tool is switched off and when it is running idle but not actually doing the job. This may significantly reduce the exposure level over the total working period.

Help to minimize your vibration exposure risk.

Maintain this tool in accordance with these instructions and keep well lubricated (where appropriate)

If the tool is to be used regularly then invest in anti vibration accessories.

Avoid using tools in temperatures of 10°C or less

# 1500W WALL CHASER

Plan your work schedule to spread any high vibration tool use across a number of days.

### **Health Surveillance**

All employees should be part of an employer's health surveillance scheme to help identify any vibration related diseases at an early stage, prevent disease progression and help employees stay in work.

### **Double insulation**

The tool is double insulated. This means that all the external metal parts are electrically insulated from the mains power supply. This is done by placing insulation barriers between the electrical and mechanical components making it unnecessary for the tool to be earthed.

### **Important note**

Be sure the supply is the same as the voltage given on the rating plate. The tool is fitted with a two-core cable and plug.

Remove the mains plug from socket before carrying out, any adjustment or servicing.

## SYMBOLS



To reduce the risk of injury, user must read instruction manual



Double insulation



Warning



Wear ear protection



Wear eye protection



Wear dust mask



Waste electrical products should not be disposed of with household waste.  
Please recycle where facilities exist. Check with your Local Authority  
or retailer for recycling advice.

yyWxx Manufacturing date code; Year of manufacturing (20yy) and week of manufacturing (Wxx);

# 1500W WALL CHASER

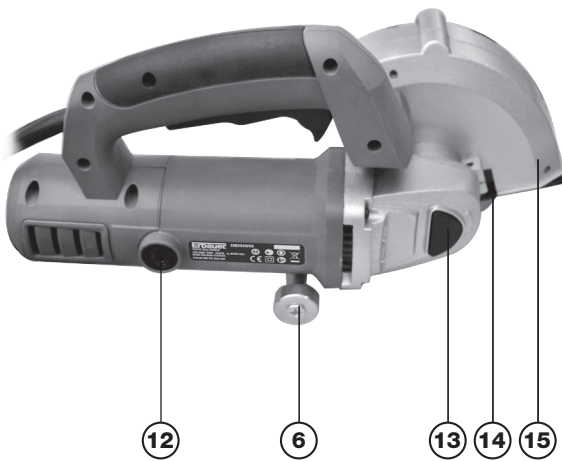
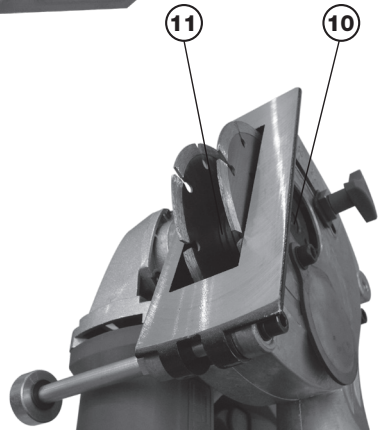
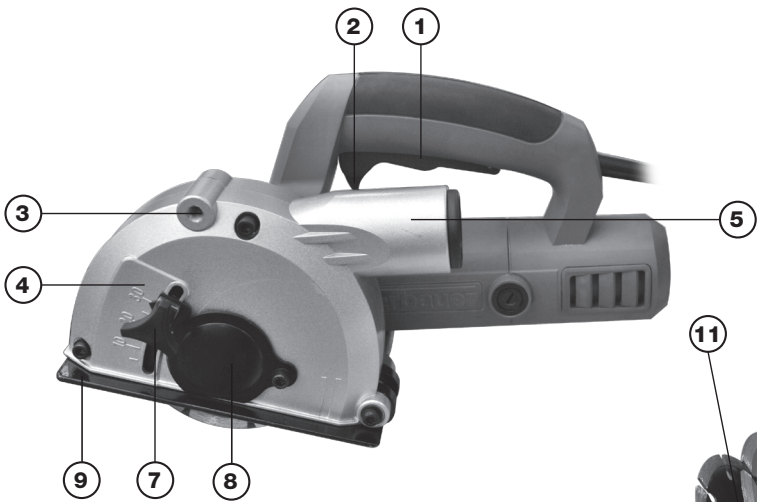

- 
1. ON/ OFF TRIGGER SWITCH

---

  2. SAFETY BUTTON OF SWITCH

---

  3. ATTACHMENT POINT FOR AUXILIARY HANDLE

---

  4. FIXED GUARD

---

  5. CONNECTION TO DUST EXTRACTION

---

  6. GUIDE WHEEL

---

  7. FLANGE CAP LOCK KNOB

---

  8. FLANGE CAP

---

  9. BASE PLATE

---

  10. OUTER FLANGE

---

  11. DISTANCE WASHERS

---

  12. CAP OF CARBON BRUSH (ON BOTH SIDES)

---

  13. SPINDLE LOCKING BUTTON

---

  14. DIAMOND CUTTING DISC

---

  15. CUTTING DIRECTION

---

  16. AUXILIARY HANDLE

---

  17. CHISEL

---

  18. SPANNER

---

  19. HEX KEY
- 

# 1500W WALL CHASER

## TECHNICAL DATA

Rated voltage	230-240V~50Hz
Rated power	1500W
Rated speed	8500/min
Blade size	125mm
Cutting depth	5-30mm
Cutting width	8-30mm
Protection class	□ /II
Weight	4.1kg

## NOISE INFORMATION

A weighted sound pressure	$L_{pA}$ : 97dB(A)
A weighted sound power	$L_{wA}$ : 108dB(A)
$K_{pA}$ & $K_{wA}$	3.0dB(A)
Wear ear protection when sound pressure is over	80dB (A)



## ACCESSORIES

125mm Diamond disc	2pcs
Spanner for screw loosen/tighten	1pc
Hex key for blade change	1pc
Chisel for material removal	1pc
Auxiliary handle	1pc

## OPERATION



**NOTE:** Before using the tool, read the instruction book carefully.

### 1. FITTING CUTTING DISCS (See Fig. 1-11)

**Warning:** Please make sure the blade is diamond cutting disc which can cut concrete, masonry and paving.

**Always turn off and unplug the tool before fitting the disc.**

Turn the button of adjusting cutting depth and the locking button anticlockwise to loosen the flange cap (See Fig.1).

Slide the cap to the side. Loose the outer flange anticlockwise by the spanner at same time press in the spindle lock button (See Fig. 2), then take out the distance washers (See Fig.3).

Make sure the inner flange on the spindle. Put the cutting disc and distance washers onto the spindle. Place the other cutting disc on the washer. (See Fig. 4,5)

Then cover the outer flange and tighten the outer flange fully clockwise by the spanner at same time press in the spindle lock button (See Fig.6).

Take down the flange cap, make it cover the hole well. Tighten the locking knob for flange cap. (See Fig.7)

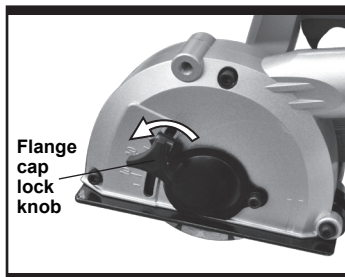

Fig. 1

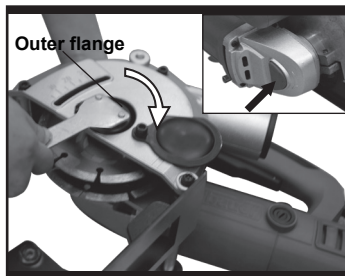

Fig. 2

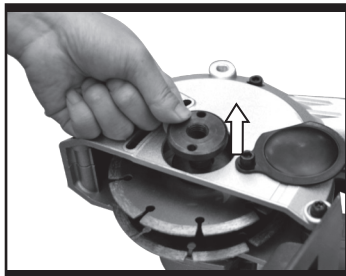

Fig. 3

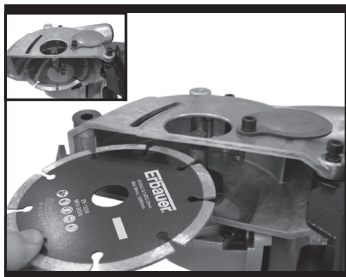

Fig. 4

# 1500W WALL CHASER

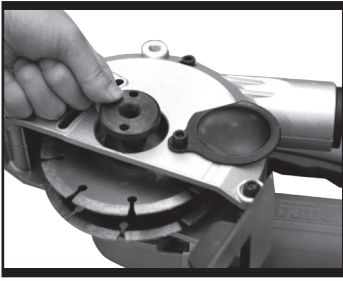

Fig. 5

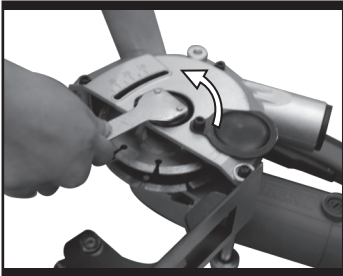

Fig. 6



Fig. 7

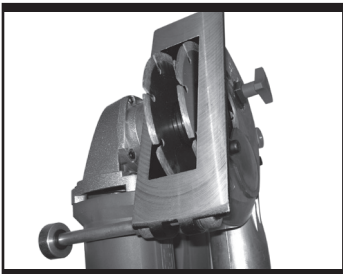

Fig. 8



## 2. ADJUSTING CHANNEL WIDTH

Turn off and unplug the tool. There are 6pcs of distance washers for adjusting the channel width. The thickness of these washers is about 4.3mm. Loosen the outer flange anti-clockwise by the spanner (See Fig. 2), take out the distance washers. Position the cutting discs at the expected width (See Fig. 8,9). Place the other distance washers and cover the outer flange, then tighten it clockwise fully.

## 3. ADJUSTING CHANNEL DEPTH

Loosen the flange cap lock knob (See Fig. 10) and lower the base plate away from the fixed guard (See Fig. 11).

Set the cutting depth as the scale provided and tighten the knob clockwise to lock.

## 4. INSTALLING THE AUXILIARY HANDLE (See Fig. 12)

For your personal safety we recommend using the auxiliary handle at all times.

To fit the handle, rotate the handle anti-clockwise until it is secured fully.

**Note:** This handle should be used at all times to maintain complete control of the tool.

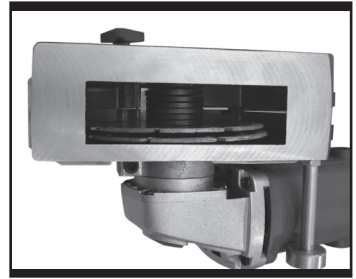

Fig. 9

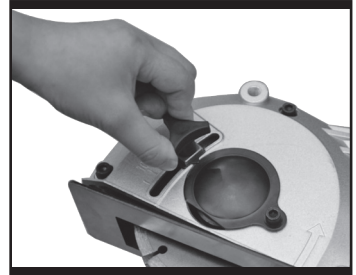

Fig. 10

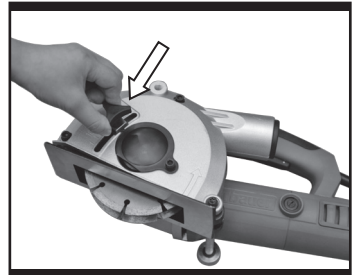

Fig. 11

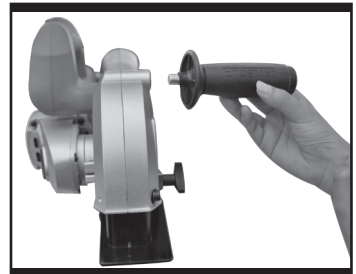

Fig. 12

# 1500W WALL CHASER



Fig. 13

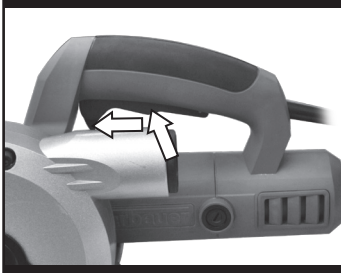

Fig. 14



Fig. 15

## 5. CONNECTING DUST EXTRACTION (See Fig. 13)

Your wall chaser is equipped with a dust extraction adapter, which is designed for collect dust task. Make sure it is tightened securely on the dust outlet. Then connect the hose of a vacuum cleaner. First please turn on the vacuum cleaner, then turn on the wall chaser. If you stop cutting, first turn off the wall chaser, then turn off your vacuum cleaner.

## 6. SWITCHING ON/OFF (See Fig. 14)

The On/Off switch is incorporated with a safety button to avoid accidental starting. To start the wall chaser first push the safety button forward, then press the On/Off switch. To turn off the grinder simply release the On/Off switch.

Important note:

Cutting of channels in materials such as concrete, masonry and paving, without the use of WATER, with a guide wheel.

## 7. REPLACING CARBON BRUSHES (See Fig. 15)

Completely unscrew the cap of carbon brush and pull out the carbon brush. Check the length of the brush and replace if under 3mm. When brushes need replacement always renew both brushes, even if one is still more than 3mm long. Put the carbon brush into the body. Cover the cap of brush and screw down. Check the tool is working before use, allow it run for a few minutes to enable the brushes to be stable.

## POSSIBLE PROBLEMS AND SOLUTIONS

<b>Problem</b>	<b>Possible cause</b>	<b>Solution</b>
The electric motor becomes hot and cuts out.	The overheating protection has been activated.	Wait several minutes until the machine has cooled down, then re-start the machine.
The machine switched will not run.	1) The overload protection has been activated. 2) The overheating protection has been activated.	1) Re-start the machine. 2) Wait several minutes until the machine has cooled down, and then re-start the machine.
Cutting is difficult and the channel made is irregular.	The cutting discs are bent or blunt.	Replace the cutting discs.
When cutting, the workpiece begins to vibrate heavily.	The cutting discs are overheated or deformed.	Replace the cutting discs.
The machine runs erratically and / or noisily,	The carbon brushes are worn.	Replace the carbon brushes.

# 1500W WALL CHASER

## MAINTENANCE

**Remove the plug from the socket before carrying out any adjustment, servicing or maintenance.**

Your power tool requires no additional lubrication or maintenance.

There are no user serviceable parts in your power tool. Never use water or chemical cleaners to clean your power tool. Wipe clean with a dry cloth. Always store your power tool in a dry place. Keep the motor ventilation slots clean. Keep all working controls free of dust. Occasionally you may see sparks through the ventilation slots. This is normal and will not damage your power tool.

If the supply cord is damaged, it must be replaced by the manufacturer, its service agent or similarly qualified persons in order to avoid a hazard.

## ENVIRONMENTAL PROTECTION



Waste electrical products should not be disposed of with household waste. Please  recycle where facilities exist. Check with your Local Authority or retailer for recycling advice. For further information visit [www.recycle-more.co.uk](http://www.recycle-more.co.uk)

## PLUG REPLACEMENT (UK & IRELAND ONLY)

If you need to replace the fitted plug then follow the instructions below.

### IMPORTANT

The wires in the mains lead are colored in accordance with the following code:

**BLUE = NEUTRAL**

**BROWN = LIVE**

As the colors of the wires in the mains lead of this appliance may not correspond with the colored markings identifying the terminals in your plug, proceed as follows. The wire which is colored blue must be connected to the terminal which is marked with **N**. The wire which is colored brown must be connected to the terminal which is marked with **L**.

**Warning:** Never connect live or neutral wires to the earth terminal of the plug. **Only fit an approved 13AMP BS1363/A plug and the correct rated fuse.**

**Note:** If a moulded plug is fitted and has to be removed take great care in disposing of the plug and severed cable, it must be destroyed to prevent engaging into a socket.

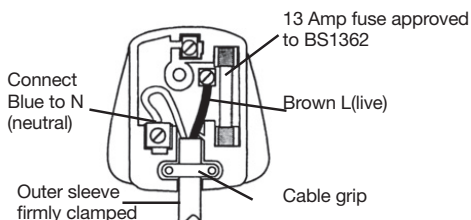

# 1500W WALL CHASER

# Erbauer®

## DECLARATION OF CONFORMITY

We, Importer

**Erbauer (UK) Ltd BA22 8RT**

Declare that the product

Description: **1500W Wall Chaser**

Model: **ERB383WCH**

Complies with the following Directives,

EC Machinery Directive **2006/42/EC**

EC Electromagnetic Compatibility Directive **2004/108/EC**

EC Low Voltage Directive **2006/95/EC**

Restrictions of the Use of Certain Hazardous Substances in Electrical and Electronic Equipment **2011/65/EU**

Waste Electrical and Electronic Equipment (WEEE) **2002/96/EC** and **2003/108/EC**

Standards conform to:

**EN 55014-1**

**EN 55014-2**

**EN 60745-1**

**EN 61000-3-2**

**EN 61000-3-3**

### Authorised Signatory and technical file holder

Date: 07/04/11

Signature: P. C. Harries

Name / title: Peter Harries / Quality Manager

Erbauer (UK) Ltd. Trade House, Mead Avenue, BA22 8RT





**Erbauer®**