

# ENERGER



## SAFETY AND OPERATING MANUAL

Original Instructions 7.0

**850W ROTARY HAMMER ENB465DRH**

# **ENERGER**

Read all safety warnings and all instructions before use. Failure to follow the warnings and instructions may result in electric shock, fire and/or serious injury.

Save all warnings and instructions for future reference.

## SPECIAL WARNING FOR HAMMER



### CAUTION

This is a very powerful Drill.

When using this drill it is essential that the following rules for use are followed!

1. When drilling it is common that the core / drill bit jams in the material being drilled. This will result in the drill trying to rotate around the drill bit and potentially come out of your grip. This SDS Drill has a safety clutch mechanism. This safety clutch mechanism will be activated and stop the drive to the drill bit BUT only if you resist the initial forces caused by the jamming by securely holding the drill with both hands. As this is a very powerful drill these forces are significant.

2. ALWAYS ensure that the front handle is firmly affixed and secure.

3. The Front and rear handle must be firmly held to resist any movement of the drill when the core drill or drill bit becomes jammed.

4. ALWAYS use this drill when standing on a firm and secure platform or the ground. (DO NOT USE ON LADDERS OR STEPS)

5. NEVER Start the Drill with the core or drill jammed in position.

6. DO NOT stretch to hold the drill. Do not drill above shoulder height or below Knee height, as the drill cannot be securely held.

7. Never drill holes that are above the declared maximum size in the manual.

## GENERAL SAFETY INSTRUCTIONS



**WARNING.** Read all safety warnings and instructions.

Failing to follow the warnings and instructions can result in an electric shock, a fire and/or a serious injury.

Keep all warnings and all instructions to be able to refer to them later on.

The term "tool" in the warnings refers to your electrical mains powered tool (with power cord) or your battery operated tool (without power cord).

### 1 Safety of the work area

a) **Keep the work area clean and well lit.** Cluttered and dark areas invite accidents.

b) **Do not operate electric tools in explosive atmospheres, for example in the presence of flammable liquids, gases or dust.** Electric tools create sparks that can ignite the dust or fumes.

c) **Keep children and bystanders away while operating the tool.** Distractions can cause you to lose control of the tool.

### 2 Electrical safety

a) **The electric tool plugs must match the outlet. Never modify the plug in any way. Do not use adapters with earthed (grounded) tools.** Unmodified plugs and matching outlets will reduce the risk of electric shock.

b) **Avoid any body contact with earthed or grounded surfaces such as pipes, radiators, cookers and refrigerators.** There is an increased risk of electric shock if your body is earthed or grounded.

c) **Do not expose tools to rain or wet conditions.** Water entering a tool will increase the risk of electrical shock.

d) **Do not abuse the cord. Never use the cord for carrying, pulling or unplugging the tool. Keep the cord away from heat, lubricants, edges and moving parts.** Damaged or entangled cords increase the risk of electric shock.

e) **When using a tool outside, use an extension cable suitable for outside use.** Use of a cord suitable for outside use reduces the risk of electric shock.

f) **If use of a tool in a humid location is unavoidable, use a supply protected by a residual current differential device (RCD).** The use of an RCD reduces the risk of electric shock.

### 3 Personal safety

- a) **Stay alert, watch what you are doing and use common sense when operating the tool. Do not use the tool when you are tired or under the influence of drugs, alcohol or medication.** One moment of carelessness while using a tool can result in serious personal injury.
- b) **Use safety equipment. Always wear eye protection.** Safety equipment such as dust masks, non-slip safety shoes, a hard hat and hearing protection used for appropriate conditions will reduce personal injuries.
- c) **Avoid unintentional starting. Make sure that the switch is in the off position before plugging the tool into the mains and/or fitting the batteries, picking it up or carrying it.** Carrying tools with your finger on the switch or plugging in tools with the switch in the on position is a cause of accidents.
- d) **Remove any adjustment key before operating the tool.** A key left attached to a rotating part of the tool can result in personal injury.
- e) **Do not overreach. Keep a proper position and balance at all times.** This enables better control of the tool in unexpected situations.
- f) **Dress in a suitable manner. Do not wear loose clothing or jewellery. Keep hair, clothing and gloves away from moving parts.** Loose clothing, jewellery or long hair can be caught in moving parts.
- g) **If devices are provided for the connection of dust extraction and collection equipment, make sure that they are connected and used correctly.** Using dust collectors can reduce the dust-related risks.

### 4 Use and maintenance of the tool

- a) **Do not force the tool. Use the correct tool for your application.** The correct tool will do the work better and safer in the conditions for which it was manufactured.
- b) **Do not use the tool if the switch does not make it possible to change from the operating condition to stop and vice versa.** Any tool which cannot be controlled by the switch is dangerous and should be repaired.
- c) **Disconnect the power cord before any adjustment, changing an accessory or before storing the tool.** Such preventive safety measures reduce the risk of starting the tool accidentally.
- d) **Keep idle tools out of the reach of children and do not allow persons unfamiliar with the tool or these instructions to operate it.** Tools are dangerous in the hands of untrained users.
- e) **Maintain the tool. Check that there is no misalignment or obstruction of the moving parts, broken parts or any other condition that could affect the operation of the tool. In the event of damage, have the tool repaired before using it.** Many accidents are due to badly maintained tools.
- f) **Keep cutting tools sharp and clean.** Properly maintained tools with sharp cutting edges are less likely to bind and are easier to control.
- g) **Use the tool, accessories and blades etc., in accordance with these instructions, while taking into account the work conditions and the work to be done.** The use of the tool for operations other than those intended could result in dangerous situations.

### 5) Service

- a) **Have your power tool serviced by a qualified repair person using only identical replacement parts.** This will ensure that the safety of the power tool is maintained.

## SPECIAL SAFETY INSTRUCTIONS

1. **Wear ear protectors.** Exposure to noise can cause hearing loss.
2. **Use auxiliary handle(s), if supplied with the tool.** Loss of control can cause personal injury.
3. **Hold power tool by insulated gripping surfaces, when performing an operation where the cutting accessory may contact hidden wiring or its own cord.** Cutting accessory contacting a "live" wire may make exposed metal parts of the power tool "live" and could give the operator an electric shock.
4. Do not use the drill near water.
5. Remove the plug from the socket before carrying out any adjustment, servicing or maintenance.
6. Fully unwind extension cords to avoid potential overheating.
7. When an extension cord is required, please ensure it has the correct ampere rating for the power tool and that it is in a safe electrical condition.
8. Ensure the supply voltage is same as rating voltage.
9. The tool is double insulated for additional protection against a possible electrical insulation failure within the tool.
10. Always check walls and ceilings to avoid hidden power cables and pipes.

11. After long working periods, external metal parts and accessories could be hot.
12. Wear eye protection when operating this tool.



**WARNING!**

Some dust created by power sanding, sawing, grinding, drilling, and other construction activities contains

chemicals known to cause cancer, birth defects or other reproductive harm. Some examples of these chemicals are:

- lead from lead-based paints,
- crystalline silica from bricks and cement and other masonry products, and
- arsenic and chromium from chemically-treated lumber.

Your risk from these exposures varies, depending on how often you do this type of work. To reduce your exposure to these chemicals: work in a well ventilated area, and work with approved safety equipment, such as those dust masks that are specially designed to filter out microscopic particles.

## NOISE INFORMATION

### Wear hearing protection!

Measured sound values determined according to EN 60745.

The noise figures quoted are emission levels and are not necessarily safe working levels. Whilst there is a correlation between the emission and exposure levels, this cannot be used reliably to determine whether or not further precautions are required. Factors that influence the actual level of exposure of work-force include the characteristics of the work room, the other sources of noise, etc. i.e. the number of machines and other adjacent processes, and the length of time for which an operator is exposed to the noise. Also the permissible exposure level can vary from country. This information, however, will enable the user of the machine to make a better evaluation of the hazard and risk.

## VIBRATION

The European Physical Agents (Vibration) Directive has been brought in to help reduce hand arm vibration syndrome injuries to power tool users. The directive requires power tool manufacturers and suppliers to provide indicative vibration test results to enable users to make informed decisions as to the period of time a power tool can be used safely on a daily basis and the choice of tool.

Further advice can be found at [www.hse.gov.uk](http://www.hse.gov.uk)

Vibration total values (triax vector sum) determined according to EN 60745:	
Hammer drilling into concrete (For main handle)	Vibration emission value $a_{h,ID} = 22.401 \text{ m/s}^2$
	Uncertainty $K = 1.5 \text{ m/s}^2$
Chiseling (For main handle)	Vibration emission value $a_{h,CHeq} = 20.145 \text{ m/s}^2$
	Uncertainty $K = 1.5 \text{ m/s}^2$
Hammer drilling into concrete (For auxiliary handle)	Vibration emission value $a_{h,ID} = 16.843 \text{ m/s}^2$
	Uncertainty $K = 1.5 \text{ m/s}^2$
Chiseling (For auxiliary handle)	Vibration emission value $a_{h,CHeq} = 15.223 \text{ m/s}^2$
	Uncertainty $K = 1.5 \text{ m/s}^2$

The declared vibration emission value should be used as a minimum level and should be used with the current guidance on vibration.

The declared vibration emission been measured in accordance with a standardised test stated above and may be used to compare one tool with another tool. The declared vibration emission value may also be used in a preliminary assessment of exposure.

### WARNING!

The vibration emission value during actual use of the power tool can differ from the declared value depending on the ways in which the tool is used dependent on the following examples and other variations on how the tool is used:

How the tool is being used and the materials being cut or drilled.

The tool being in good condition and well maintained

The use the correct accessory for the tool and ensuring it is sharp and in good condition.

The tightness of the grip on the handles.

And the tool is being used as intended by its design and these instructions.

While working with this power tool, hand/arm vibrations occur. Adopt the correct working practices in order to reduce the exposure to vibration.

This tool may cause hand-arm vibration syndrome if its use is not adequately managed.

## **WARNING!**

Identify safety measures to protect the operator that are based on an estimation of exposure in the actual conditions of use (taking account of all parts of the operating cycle such as the times when the tool is switched off and when it is running idle in addition to the trigger time).

## **Vibration and noise reduction**

To reduce the impact of noise and vibration emission, limit the time of operation, use low-vibration and low-noise operating modes as well as wear personal protective equipment.

Take the following points into account to minimize the vibration and noise exposure risks:

1. Only use the product as intended by its design and these instructions.
2. Ensure that the product is in good condition and well maintained.
3. Use correct application tools for the product and ensure they in good condition.
4. Keep tight grip on the handles/grip surface.
5. Maintain this product in accordance with these instructions and keep it well lubricated (where appropriate).
6. Plan your work schedule to spread any high vibration tool use across a number of days.

## **Emergency**

Familiarise yourself with the use of this product by means of this instruction manual. Memorise the safety directions and follow them to the letter. This will help to prevent risks and hazards.

1. Always be alert when using this product, so that you can recognise and handle risks early. Fast intervention can prevent serious injury and damage to property.
2. Switch off and disconnect the machine from the power supply if there is any malfunction. Have the product checked by a qualified specialist and repaired, if necessary, before you put it into operation again.

## **Residual risks**

**Even if you are operating this product in accordance with all the safety requirements, potential risks of injury and damage remain. The following dangers can arise in connection with the structure and design of this product:**

1. Health defects resulting from vibration emission if the product is being used over long periods of time or not adequately managed and properly maintained.
2. Injuries and damage to property due to broken application tools or the sudden impact of hidden objects during use.
3. Danger of injury and property damage caused by flying objects.

## **WARNING!**

**This product produces an electromagnetic field during operation! This field may under some circumstances interfere with active or passive medical implants! To reduce the risk of serious or fatal injury, we recommend persons with medical implants to consult their doctor and the medical implant manufacturer before operating this product!**

## **Health Surveillance**

All employees should be part of an employer's health surveillance scheme to help identify any vibration related diseases at an early stage, prevent disease progression and help employees stay in work.

### **Torque limiter**

There is a clutch in your hammer drill. The torque limiter will actuate when a certain torque level is reached. The motor will disengage from the output shaft. When this happens, the bit will stop turning. As soon as the torque limiter actuates, release the trigger and remove the tool and bit immediately. This will help prevent premature wear of the tool.

### **Double insulation**

The tool is double insulated. This means that all the external metal parts are electrically insulated from the mains power supply. This is done by placing insulation barriers between the electrical and mechanical components making it unnecessary for the tool to be earthed.

### **Important note**

Be sure the supply is the same as the voltage given on the rating plate. The tool is fitted with a two-core cable and plug.

Remove the mains plug from socket before carrying out, any adjustment or servicing.

### **Intended use**

The machine is intended for hammer /hammer drilling in brick,concrete and stone as well as for drilling in wood,metal and plastic.



## SYMBOLS

The symbols shown on the product has great significance for the safe use of the product.



WARNING - To reduce the risk of injury, user must read the instruction manual



Wear eye protection  
Wear ear protection  
Wear respiratory protection  
Wear safety gloves



Double insulation Class II



Conforms to all relevant safety standards.



Warning

yyWxx Manufacturing date code:

Year of manufacturing (20yy) and week of manufacturing (Wxx);

## LIST OF MAIN PART

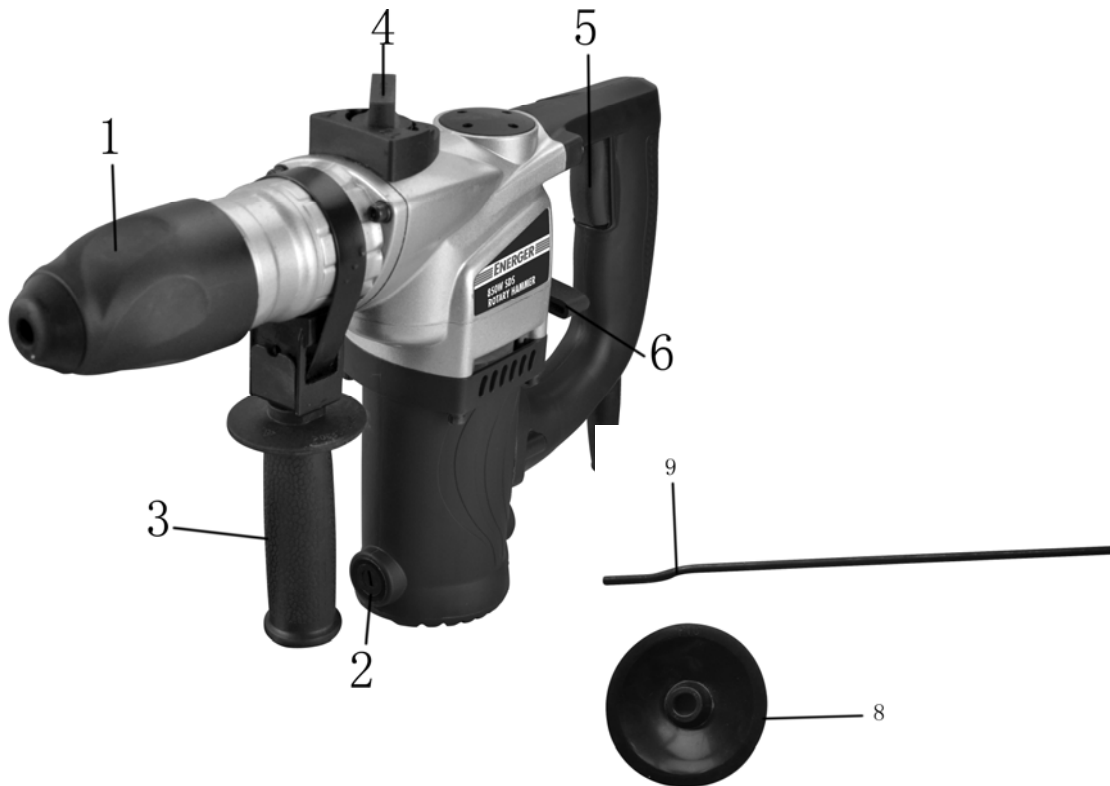

- 1 SDS chuck
- 2 Carbon brush cover
- 3 Auxiliary handle
- 4 Front hammer/drill switch with locking knob
- 5 On / off switch
- 6 Rear hammer/drill switch
- 7 Cable
- 8 Dust cover
- 9 Depth gauge

## TECHNICAL DATA

Model		ENB465DRH
Rated voltage		230-240V~50Hz
Rated power		850W
No load speed		850min <sup>-1</sup>
Max drilling capability	Wood:	40mm
	Masonry:	26mm
	Steel:	13mm
Weight		4.2kg

## NOISE DATA

Sound pressure level :  $L_{pA} = 92.7$  dB(A) Uncertainty K=3dB(A)  
Sound power level :  $L_{wA} = 103.7$ dB(A) Uncertainty K=3dB(A)

Wear ear protection when sound pressure is over 80dB(A)

## ACCESSOIRES

The machine comes with the following accessories :

- 1 pc Auxiliary handle
- 1 pc Dust cover
- 1 pc Depth stop
- 3 pcs Masonry drill bits 8/10/12x150mm
- 1pc Flat chisel 14x250mm
- 1pc Point chisel 250mm

## BEFORE USE

Before making assembly, changing and adjustment for any accessory, disconnect the tool from the mains supply to avoid any unintentional starting.

Please always check the mains supply voltage before use! It must correspond with the rating label on the appliance.

Remove any packing material and loose parts from unit.

Check the accessories before use. It should be fit with the machine and your purpose.

## Operating instructions

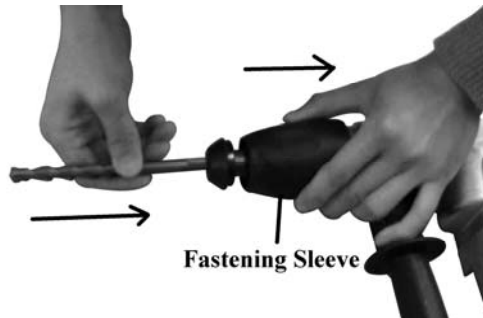

Fig.1

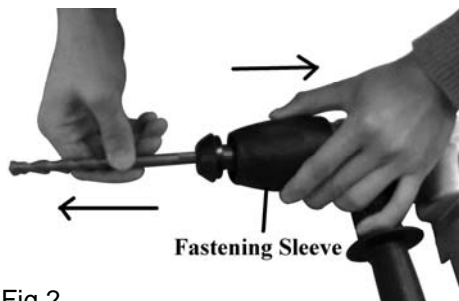

Fig.2



Fig.3



Fig.4

### 1. FITTING AND REMOVING THE DRILL BITS

**NOTE:** The device is supplied with a SDS-plus chuck.

1. Clean the tip of the accessory and lubricate it lightly with a light oil or lubricant before insertion.
2. Pull back and hold the fastening sleeve.
3. Insert accessory in SDS plus chuck while turning and pushing it until it engages.
4. Make sure the bit has been locked by pulling and turning. (Fig.1)

**NOTE:** The accessory requires freedom of movement which causes eccentricity when tool is off-load; however, the accessory automatically centers itself during operation without affecting drilling precision.

#### Removing the SDS-plus Tool

1. Pull back and hold the fastening sleeve. (Fig.2)
2. Turning and pulling the accessory and then remove it from SDS plus chuck.

### 2.INSTALLING THE AUXILIARY HANDLE

Drag the handle on the tool head.

Turn the handle clockwise to lock and tighten securely (Fig.3).

The auxiliary handle can be mounted on the left or right side of the machine.

Depending on the working method, the auxiliary handle can be adjusted in different positions.

#### **CAUTION!**

The machine should be used only with both handles.

Do not continue to use an auxiliary handle if it is damaged.

### 3.INSTALLING THE DEPTH STOP ( Fig.4)

The drilling depth can be set with the depth gauge.

Insert a drill bit into the chuck and clamp it.

Loosen the auxiliary handle and insert the depth gauge into the intended hole.

Move the depth gauge until the distance between the tips of drilling bit and depth gauge corresponds with the required drilling depth.

Tighten the auxiliary handle by turning the grip of the handle clockwise in its desired position.



Fig.5



Fig.6

#### 4. DUST COLLECTION DEVICE (Fig.5)

**NOTE:** The dust cap is ideal when working overhead (vertically). It protects the user from falling dust which may restrict vision.

1. Before fitting the drill bit, pull the dust cap down the length of the drill bit ensuring the recessed end of the cap is pointing towards the tip of the drill bit.
2. Fit the drill bit into the chuck.
3. Adjust the dust cap before use so that it does not rest on the cutters of the drill bit.

#### 5. ON/OFF SWITCH

Depress the On/Off switch to start and release it to stop your drill.(Fig.6)

#### 6. REPLACING OF CARBON BRUSHES

The carbon brushes are expendable. It is keeping abrasion during use.

The carbon brushes should be changed regularly. In order not to damage the electrical circuit, both carbon brushes should be changed at the same time.

#### **CAUTION!**

The machine should be used only with both brushes!















## HAMMER/DRILL SWITCH

The hammer/drill switches can switch the drill, hammer and hammer/ drill functions. There is a lock knob in front hammer/ drill switch, please depressed it first to preventing any unintentional adjusting.

### WRNING!

Please check and make sure the function switch has been fixed by locking knob after each adjustment.

To set the function, please use below compounding of front and rear hammer/drill switch:

 	<p>Hammer drilling mode:</p> <p>Set the front hammer/drill switch to the position  and the rear hammer drill switch to the position . This setting is recommended for use when drilling holes in concrete and other masonry products. The hammer action will be in operation while simultaneously the drill bit rotates</p>
 	<p>Hammer mode:</p> <p>Set the front hammer/drill switch to the position  and the rear hammer drill switch to the position . This setting is recommended for use when you desire a hammer action without the accessory rotating which is ideal for "chiseling or chipping" away at masonry products, chisel accessory bits should be used.</p>
 	<p>Drilling mode:</p> <p>Set the front hammer/drill switch to the position  and the rear hammer drill switch to the position . This setting is recommended for use when you desire the accessory to rotate without hammer action. Ideal for drilling into timber or steel when the correct accessories for such materials are used.</p>
 	<p></p> <p><b>WARNING</b></p> <p>No function mode: The motor turns without load, the shaft will not turn. Do not set the switch like this. It may damage the motor greatly.</p>

## **DRILLING OPERATION**

### **Drilling wood**

1. For drilling into wood, ensure the selection switch is set to the regular drilling function (drilling mode only).
2. When drilling into soft wood, the drill should be operated at high speed.
3. When drilling into hard wood, the drill should be operated at low speed.
4. Ensure you are using a twist drill bit.
5. Ensure the workpiece is clamped or anchored firmly before operation.
6. Apply pressure in a straight line to the drill bit while maintaining enough pressure to ensure the bit bites into the material.
7. When drilling into wood the bit may overheat unless pulled out regularly to clean the chips from the flutes.
8. When drilling into materials that may splinter use a back-up block of wood.

### **Drilling metals**

1. For drilling into metals, ensure the selection switch is set to the regular drilling position (drilling mode only).
2. It is important to lubricate the tip of the bit from time to time with a cutting oil. The exceptions to this are iron, brass, aluminium, copper and cast iron.
3. Before commencing drilling make an indentation with a centre punch. This will help prevent the bit from slipping.
4. Operate the drill at a slow speed.
5. When drilling large holes it is advisable to drill a smaller hole first.
6. Maintain firm pressure on the drill so the bit does not wonder. A wondering drill bit may cause injury.
7. Avoid the drill bit spinning freely in the hole after it is drilled. This will cause the bit to become dull.

### **Drilling or chiseling masonry**

1. For drilling into stone, bricks, marble and concrete, ensure the selection switch is set to the hammer or hammer drilling mode.
2. Ensure that a masonry drill or chisel bits is being used.
3. Maintain firm pressure on the machine so the bit does not wonder. A wondering bit may cause injury.
4. Carbide tipped masonry bits should be used for all masonry drilling.

## TERMS OF USE

When all precautions have been taken and the previous operations were done, you can start working. Always secure the work piece especially if it is small and the sheets.

Use the hammer drill suitable for the material.

Drilling:

In the woods, a burned area indicates an inappropriate speed or a bit sharpened improperly.

In steel, lubricate to prevent overheating and premature wear of the drill.

In steel, it is recommended to drill out regularly to remove chips and cool the drill. For large holes, make pilot holes.

Hammer or hammer drilling

In the materials (concrete, ...), stay in the extension of the machine, perpendicular to the surface to be drilled. Use the auxiliary handle to catch the couple, especially for large diameters. Hold the unit firmly with both hands.

## CARE AND MAINTENANCE

Keep the ventilation openings clear and clean the product regularly. This machine requires no special mechanical maintenance such as greasing the bearings.

If something unusual occurs during use, switch off the supply and disconnect the plug. Inspect and repair the tool before using it again. The repairs must be carried out by a qualified technician.

**Repair of the tool must only be carried out by a qualified repair technician.**

Repair or maintenance by unqualified personnel can lead to a risk of injury.

Use only identical spare parts for repairing a tool.

### Caution!

If the supply cord of this power tool is damaged, it must be replaced by a specially prepared cord available through the service organization.

### Care and cleaning

Cleaning of plastic parts is disconnected machines, using a soft damp cloth and a mild soap.

Never immerse the machine and do not use detergent, alcohol, petrol, etc..

In case of problems or for a deep cleaning, consult the manufacturer, its service agent or a similarly qualified person to avoid a hazard.

## STORING

Store the machine, operating instructions and where necessary the accessories in the original packaging. In this way you will always have all the information and parts ready to hand.

Pack the device well or use the original packaging in order to avoid transit damage.

Always keep the machine in dry place.



## GUARANTEE

This ENERGER product carries a guarantee of 12 months.

If your product develops a fault within this period, you should, in the first instance contact the retailer where the item was purchased.

This guarantee specifically excludes losses caused due to:

- Fair wear and tear
  - Misuse or abuse
  - Lack of routine maintenance
  - Failure of consumable items
  - Accidental damage
  - Cosmetic damage
  - Failure to follow manufacturer's guidelines
  - Loss of use of the goods
- This guarantee does not affect your statutory rights.

This guarantee is only valid in the UK. For any enquiries relating to the guarantee please refer to your retailer.

## ENVIRONMENTAL PROTECTION



This product is marked with the selective sorting symbol on waste electrical and electronic equipment. This means that this product should not be disposed of with household waste but must be supported by a collection system in accordance with Directive 2002/96/EC. It will then be recycled or dismantled to minimize impacts on the environment, electrical and electronic products are potentially hazardous to the environment and human health due to the presence of hazardous substances.

## PLUG REPLACEMENT (UK & IRELAND ONLY)

If you need to replace the fitted plug then follow the instructions below.

### IMPORTANT

The wires in the mains lead are colored in accordance with the following code:

**BLUE = NEUTRAL**

**Brown = Live**

As the colors of the wires in the mains lead of this appliance may not correspond with the colored markings identifying the terminals in your plug, proceed as follows. The wire which is colored blue must be connected to the terminal which is marked with N. The wire which is colored brown must be connected to the terminal which is marked with L.

### Warning:

Never connect live or neutral wires to the earth terminal of the plug. **Only fit an approved 13AMP BS1363/A plug and the correct rated fuse.**

**Note:** If a moulded plug is fitted and has to be removed take great care in disposing of the plug and severed cable, it must be destroyed to prevent engaging into a socket.

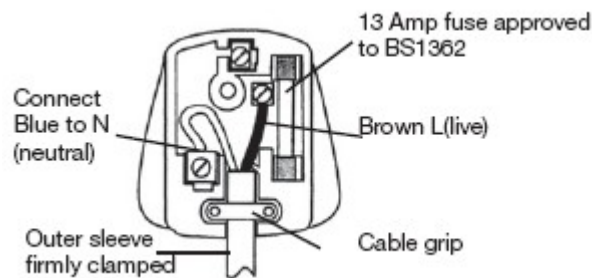



**Declaration of Conformity**

We, Importer  
**Powersmith (UK) LTD.**  
Trade house, Mead Avenue, BA22 8RT

Declare that the product:  
**Designation: ROTARY HAMMER 850W**  
**Model: ENB465DRH**

Complies with the following Directives:  
**2004/108/EC** Electromagnetic Compatibility Directive  
**2006/42/EC** Machinery Directive  
**2006/95/EC** Low Voltage Directive  
**2011/65/EU** Restrictions of the Use of Certain Hazardous Substances in  
Electrical and Electronic Equipment  
**2002/96/EC and 2003/108/EC** Waste Electrical and Electronic Equipment  
(WEEE)

Standards and technical specifications referred to:

**EN 55014-1**  
**EN 55014-2**  
**EN 61000-3-2**  
**EN 61000-3-3**  
**EN 60745-1**  
**EN 60745-2-6**

Authorised Signatory and technical file holder

Date : 07/09/2012

Signature: P.C. Harries



Name / title: Peter Harries / Quality Manager  
Powersmith (UK) LTD. Trade House , Mead Avenue ,BA22 8RT

**850W ROTARY HAMMER ENB465DRH**