

DEWALT®

www.**DEWALT**.eu

D25012
D25013

Figure 1

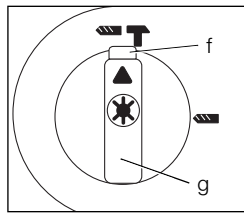
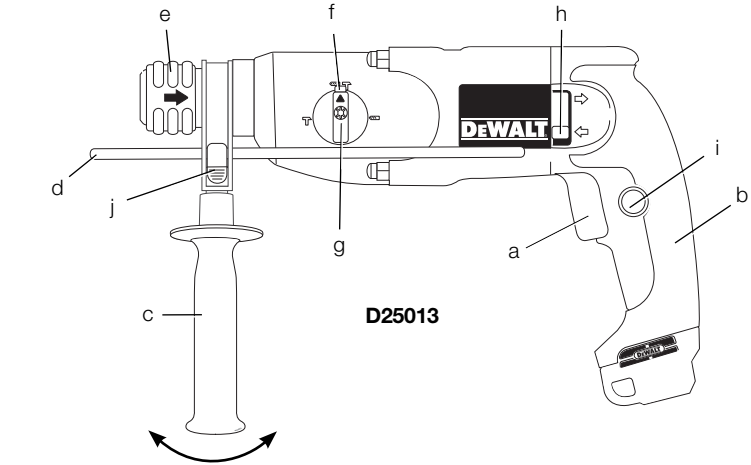

D25012

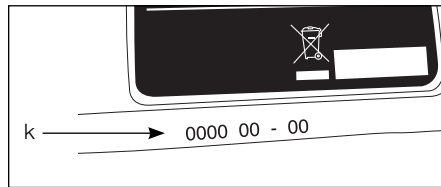

Figure 2

D25013

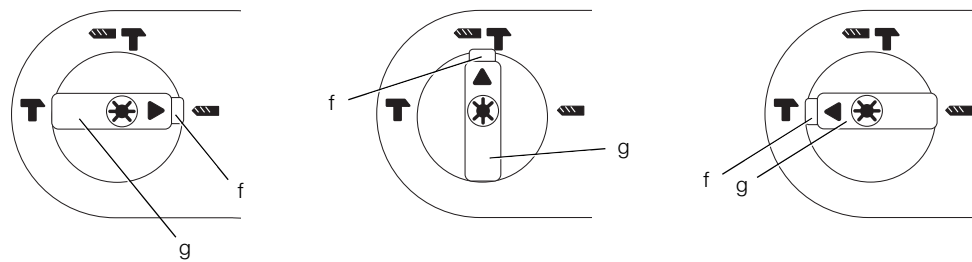

Figure 3

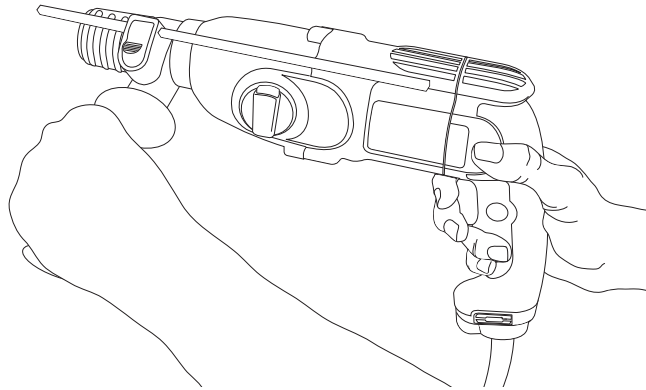
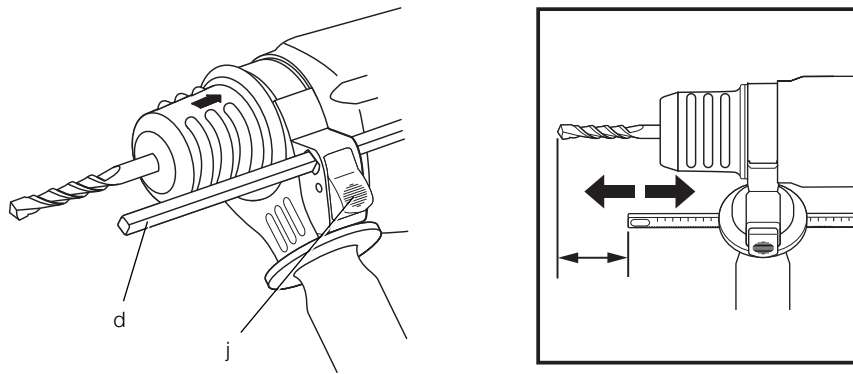

Figure 4



HEAVY-DUTY SDS PLUS® ROTARY HAMMERS

D25012, D25013

Congratulations!

You have chosen a DEWALT tool. Years of experience, thorough product development and innovation make DEWALT one of the most reliable partners for professional power tool users.

Technical Data

		D25012	D25013
Voltage	V	230	230
	(U.K. & Ireland only)	V 230/115	230/115
Type		1	1
Power input	W	650	650
No-load speed	min ⁻¹	0–1550	0–1550
Load speed	min ⁻¹	0–1130	0–1240
Beats per minute	BPM	0–4150	0–4550
Impact energy	Hammerdrilling	J 2.4	2.4
	Chiselling	J 2.4	2.4
Maximum drilling range in steel/wood/concrete	mm	13/30/22	13/30/22
	Chisel positions	–	41
Core drilling capacity in soft brick	mm	50	50
	Tool holder	SDS Plus®	SDS Plus®
Collar diameter	mm	43	43
Weight	kg	2.3	2.3
L _{PA} (sound pressure)	dB(A)	86	89
K _{PA} (sound pressure uncertainty)	dB(A)	3.0	3.0
L _{WA} (sound power)	dB(A)	97	100
K _{WA} (sound power uncertainty)	dB(A)	3.1	3.3

Vibration total values (triax vector sum) determined according to EN 60745:

		D25012	D25013
Drilling into metal	Vibration emission		
	value $a_{h,D}$ =	m/s ² 3.0	3.0
	Uncertainty K =	m/s ² 1.5	1.5
Drilling into concrete	Vibration emission		
	value $a_{h,HD}$ =	m/s ² 11	11
	Uncertainty K =	m/s ² 1.7	1.7

Chiselling

Vibration emission

value $a_{h,Cheq}$ =	m/s ²	–	9.5
Uncertainty K =	m/s ²	–	1.7

Screwdriving without impact

Vibration emission value a_h =	m/s ²	≤ 2.5	≤ 2.5
Uncertainty K =	m/s ²	1.5	1.5

The vibration emission level given in this information sheet has been measured in accordance with a standardised test given in EN 60745 and may be used to compare one tool with another. It may be used for a preliminary assessment of exposure.



WARNING: The declared vibration emission level represents the main applications of the tool. However if the tool is used for different applications, with different accessories or poorly maintained, the vibration emission may differ. This may significantly increase the exposure level over the total working period.

An estimation of the level of exposure to vibration should also take into account the times when the tool is switched off or when it is running but not actually doing the job. This may significantly reduce the exposure level over the total working period.

Identify additional safety measures to protect the operator from the effects of vibration such as: maintain the tool and the accessories, keep the hands warm, organisation of work patterns.

Fuses:

Europe	230 V tools	10 Amperes, mains
U.K. & Ireland	230 V tools	13 Amperes, in plugs
U.K. & Ireland	115 V tools	16 Amperes, in plugs

Definitions: Safety Guidelines

The definitions below describe the level of severity for each signal word. Please read the manual and pay attention to these symbols.



DANGER: Indicates an imminently hazardous situation which, if not avoided, will result in **death or serious injury**.



WARNING: Indicates a potentially hazardous situation which, if not avoided, **could** result in **death or serious injury**.



CAUTION: Indicates a potentially hazardous situation which, if not avoided, **may** result in **minor or moderate injury**.

NOTICE: Indicates a practice **not related to personal injury** which, if not avoided, **may** result in **property damage**.



Denotes risk of electric shock.



Denotes risk of fire.

EC-Declaration of Conformity

MACHINERY DIRECTIVE



D25012, D25013

DEWALT declares that these products described under "technical data" are in compliance with: 98/37/EC (until Dec. 28, 2009), 2006/42/EC (from Dec. 29, 2009), EN 60745-1, EN 60745-2-6.

These products also comply with Directive 2004/108/EC. For more information, please contact DEWALT at the following address or refer to the back of the manual.

The undersigned is responsible for compilation of the technical file and makes this declaration on behalf of DEWALT.

Horst Grossmann
Vice President Engineering and Product
Development
DEWALT, Richard-Klinger-Straße 11,
D-65510, Idstein, Germany
27.07.2009



WARNING: To reduce the risk of injury, read the instruction manual.

General Power Tool Safety Warnings



WARNING! Read all safety warnings and instructions Failure to follow the warnings and instructions may result in electric shock, fire and/or serious injury.

SAVE ALL WARNINGS AND INSTRUCTIONS FOR FUTURE REFERENCE

The term "power tool" in the warnings refers to your mains-operated (corded) power tool or battery-operated (cordless) power tool.

1) WORK AREA SAFETY

- a) **Keep work area clean and well lit.** Cluttered or dark areas invite accidents.
- b) **Do not operate power tools in explosive atmospheres, such as in the presence of flammable liquids, gases or dust.** Power tools create sparks which may ignite the dust or fumes.
- c) **Keep children and bystanders away while operating a power tool.** Distractions can cause you to lose control.

2) ELECTRICAL SAFETY

- a) **Power tool plugs must match the outlet. Never modify the plug in any way. Do not use any adapter plugs with earthed (grounded) power tools.** Unmodified plugs and matching outlets will reduce risk of electric shock.
- b) **Avoid body contact with earthed or grounded surfaces such as pipes, radiators, ranges and refrigerators.** There is an increased risk of electric shock if your body is earthed or grounded.
- c) **Do not expose power tools to rain or wet conditions.** Water entering a power tool will increase the risk of electric shock.
- d) **Do not abuse the cord. Never use the cord for carrying, pulling or unplugging the power tool. Keep cord away from heat, oil, sharp edges or moving parts.** Damaged or entangled cords increase the risk of electric shock.
- e) **When operating a power tool outdoors, use an extension cord suitable for outdoor use.** Use of a cord suitable for outdoor use reduces the risk of electric shock.
- f) **If operating a power tool in a damp location is unavoidable, use a residual current device (RCD) protected supply.** Use of an RCD reduces the risk of electric shock.

3) PERSONAL SAFETY

- a) **Stay alert, watch what you are doing and use common sense when operating a power tool. Do not use a power tool while you are tired or under the influence of drugs, alcohol or medication.** A moment of inattention while operating power tools may result in serious personal injury.
- b) **Use personal protective equipment. Always wear eye protection.** Protective equipment such as dust mask, non-skid safety shoes, hard hat, or hearing protection used for appropriate conditions will reduce personal injuries.
- c) **Prevent unintentional starting. Ensure the switch is in the off position before connecting to power source and/or battery pack, picking up or carrying the tool.** Carrying power tools with your finger on the switch or energising power tools that have the switch on invites accidents.
- d) **Remove any adjusting key or wrench before turning the power tool on.** A wrench or a key left attached to a rotating part of the power tool may result in personal injury.
- e) **Do not overreach. Keep proper footing and balance at all times.** This enables better control of the power tool in unexpected situations.
- f) **Dress properly. Do not wear loose clothing or jewellery. Keep your hair, clothing and gloves away from moving parts.** Loose clothes, jewellery or long hair can be caught in moving parts.
- g) **If devices are provided for the connection of dust extraction and collection facilities, ensure these are connected and properly used.** Use of dust collection can reduce dust-related hazards.

4) POWER TOOL USE AND CARE

- a) **Do not force the power tool. Use the correct power tool for your application.** The correct power tool will do the job better and safer at the rate for which it was designed.
- b) **Do not use the power tool if the switch does not turn it on and off.** Any power tool that cannot be controlled with the switch is dangerous and must be repaired.
- c) **Disconnect the plug from the power source and/or the battery pack from the power tool before making any adjustments, changing accessories, or storing power tools.** Such preventive safety measures reduce the risk of starting the power tool accidentally.

- d) **Store idle power tools out of the reach of children and do not allow persons unfamiliar with the power tool or these instructions to operate the power tool.** Power tools are dangerous in the hands of untrained users.
- e) **Maintain power tools. Check for misalignment or binding of moving parts, breakage of parts and any other condition that may affect the power tool's operation. If damaged, have the power tool repaired before use.** Many accidents are caused by poorly maintained power tools.
- f) **Keep cutting tools sharp and clean.** Properly maintained cutting tools with sharp cutting edges are less likely to bind and are easier to control.
- g) **Use the power tool, accessories and tool bits etc., in accordance with these instructions taking into account the working conditions and the work to be performed.** Use of the power tool for operations different from those intended could result in a hazardous situation.

5) SERVICE

- a) **Have your power tool serviced by a qualified repair person using only identical replacement parts.** This will ensure that the safety of the power tool is maintained.

Additional Specific Safety Rules for Rotary Hammers

- **Wear ear protectors.** Exposure to noise can cause hearing loss.
- **Use auxiliary handles supplied with the tool.** Loss of control can cause personal injury.
- **Hold power tools by insulated gripping surfaces when performing an operation where the cutting tool may contact hidden wiring or its own cord.** Contact with a "live" wire will make exposed metal parts of the tool "live" and shock the operator.
- **Use clamps or other practical way to secure and support the workpiece to a stable platform.** Holding the work by hand or against your body is unstable and may lead to loss of control.
- **Wear safety goggles or other eye protection.** Hammering operations cause chips to fly. Flying particles can cause permanent eye damage. Wear a dust mask or respirator for applications that generate dust. Ear protection may be required for most applications.

ENGLISH

- **Keep a firm grip on the tool at all times. Do not attempt to operate this tool without holding it with both hands.** It is recommended that the side handle be used at all times. Operating this tool with one hand will result in loss of control. Breaking through or encountering hard materials such as re-bar may be hazardous as well. Tighten the side handle securely before use.
- **Do not operate this tool for long periods of time.** Vibration caused by hammer action may be harmful to your hands and arms. Use gloves to provide extra cushion and limit exposure by taking frequent rest periods.
- **Do not recondition bits yourself.** Chisel reconditioning should be done by an authorized specialist. Improperly reconditioned chisels could cause injury.
- **Wear gloves when operating tool or changing bits.** Accessible metal parts on the tool and bits may get extremely hot during operation. Small bits of broken material may damage bare hands.
- **Never lay the tool down until the bit has come to a complete stop.** Moving bits could cause injury.
- **Do not strike jammed bits with a hammer to dislodge them.** Fragments of metal or material chips could dislodge and cause injury.
- **Slightly worn chisels can be resharpened by grinding.**
- **Keep the power cord away from the rotating bit. Do not wrap the cord around any part of your body.** An electric cord wrapped around a spinning bit may cause personal injury and loss of control.

Residual Risks

The following risks are inherent to the use of rotary hammers:

- Injuries caused by touching the rotating parts or hot parts of the tool.

In spite of the application of the relevant safety regulations and the implementation of safety devices, certain residual risks cannot be avoided. These are:

- Impairment of hearing.
- Risk of squeezing fingers when changing the accessory.
- Health hazards caused by breathing dust developed when working in concrete and/or masonry.

Markings on Tool

The following pictograms are shown on the tool:



Read instruction manual before use.



Wear ear protection.



Wear eye protection.

DATE CODE POSITION (FIG. 1)

The Date Code (k), which also includes the year of manufacture, is printed into the housing.

Example:

2009 XX XX

Year of Manufacture

Package Contents

The package contains:

- 1 Heavy-duty rotary hammer
- 1 Side handle
- 1 Depth adjustment rod
- 1 Kitbox (K models only)
- 1 SDS Plus® chuck adapter (C models only)
- 1 Chuck (C models only)
- 1 Instruction manual
- 1 Exploded drawing
- Check for damage to the tool, parts or accessories which may have occurred during transport.
- Take the time to thoroughly read and understand this manual prior to operation.

Description (fig. 1)



WARNING: Never modify the power tool or any part of it. Damage or personal injury could result.

- Variable speed trigger switch
- Main handle
- Side handle
- Depth rod
- SDS Plus® chuck
- Mode selector button
- Mode selector

- h. Reversing lever
- i. Lock-on button
- j. Depth rod release button

INTENDED USE

These heavy-duty rotary hammers have been designed for professional drilling and hammerdrilling, screwdriving and light chipping

DO NOT use under wet conditions or in presence of flammable liquids or gases.

These rotary hammers are professional power tools.

DO NOT let children come into contact with the tool. Supervision is required when inexperienced operators use this tool.

Electrical Safety

The electric motor has been designed for one voltage only. Always check that the power supply corresponds to the voltage on the rating plate.



Your DEWALT tool is double insulated in accordance with EN 60745; therefore no earth wire is required.



WARNING: 115 V units have to be operated via a fail-safe isolating transformer (manufactured according BS EN 61558 & BS 4343) with an earth screen between the primary and secondary winding.

If the supply cord is damaged, it must be replaced by a specially prepared cord available through the DEWALT service organization.

Mains Plug Replacement (U.K. & Ireland Only)

If a new mains plug needs to be fitted:

- Safely dispose of the old plug.
- Connect the brown lead to the live terminal in the plug.
- Connect the blue lead to the neutral terminal.



WARNING: No connection is to be made to the earth terminal.

Follow the fitting instructions supplied with good quality plugs. Recommended fuse: 13 A.

Using an Extension Cable

If an extension cable is required, use an approved extension cable suitable for the power input of this tool (see technical data).

The minimum conductor size is 1.5 mm².

When using a cable reel, always unwind the cable completely.

ASSEMBLY AND ADJUSTMENTS



WARNING: To reduce the risk of injury, turn unit off and disconnect machine from power source before installing and removing accessories, before adjusting or changing set-ups or when making repairs. Be sure the trigger switch is in the OFF position. An accidental start-up can cause injury.

Side Handle (fig. 1)



WARNING: To reduce the risk of personal injury, **ALWAYS** operate the tool with the side handle properly installed and securely tightened. Failure to do so may result in the side handle slipping during tool operation and subsequent loss of control. Hold tool with both hands to maximize control.

A side handle comes assembled with this rotary hammer. The side handle (c) can be fitted to suit both right-hand and left-hand users.

TO ADJUST THE SIDE HANDLE

1. Loosen the side handle (c) by turning it counterclockwise.
2. Rotate the side handle to the desired position.
3. Tighten the side handle by turning it clockwise.

TO CHANGE SIDES

For right-hand users: slide the side handle clamp over the chuck, handle at the left.

For left-hand users: slide the side handle clamp over the chuck, handle at the right.

Reversing Lever (fig. 1)

The reversing lever (h) is used to reverse the rotary hammer for backing out fasteners or jammed bits in the drill-only function.



CAUTION: When reversing to clear jammed bits, be ready for strong reactive torque.

To reverse the rotary hammer, turn it off and align the reversing lever (h) with the yellow arrow pointing backward (viewed when holding drill in operating position).

To position the lever for forward operation, turn the rotary hammer off and align the reversing lever (h) with the yellow arrow pointing forward (viewed when holding drill in operating position).

Mode Selector (fig. 1, 2)

NOTICE: Tool must come to a complete stop before activating the mode selector button or damage to the tool may result.

1. To select the operating mode, press mode selector button (f) and turn the mode selector (g) so the yellow arrow points to the corresponding symbol.
2. Release the mode selector button and check that the mode selector switch is locked in place.

NOTE: The yellow arrow on the mode selector **MUST** be aligned with one of the symbols at all times. There are no operable positions between the positions.



ROTARY DRILLING MODE

Use rotary drilling mode for wood, metal, and plastics.



HAMMERDRILL MODE

Use this mode for masonry drilling.



HAMMER-ONLY MODE (D25013 ONLY)

For light chiseling.

Inserting and Removing SDS Plus® Accessories (fig. 1)



WARNING: Always wear gloves when you change accessories. The exposed metal parts on the tool and accessory may become extremely hot during operation.



WARNING: Do not attempt to tighten or loosen drill bits (or any other accessory) by gripping the front part of the chuck and turning the tool on. Damage to the chuck and personal injury may occur.

This tool uses SDS Plus® accessories. We recommend to use professional accessories only.

To insert bit, insert shank of bit about 19 mm (3/4") into chuck. Push and rotate bit until it locks in place. The bit will be securely held.

To release bit, pull the chuck sleeve (e) back and remove the bit.

SDS Plus® Chuck (fig. 1)



WARNING: To reduce the risk of serious personal injury, turn tool off and disconnect tool from power source before making any adjustments or removing/installing attachments or accessories.



WARNING: Burn Hazard. ALWAYS wear gloves when changing bits. Accessible metal parts on the tool and bits may get extremely hot during operation. Small bits of broken material may damage bare hands.



WARNING: Do not attempt to tighten or loosen drill bits (or any other accessory) by gripping the front part of the chuck and turning the tool on. Damage to the chuck and personal injury may occur.

To insert bit, insert shank of bit about 19 mm (3/4") into chuck. Push and rotate bit until it locks in place. The bit will be securely held.

To release bit, pull the chuck sleeve (e) back and remove the bit.

Fitting a Chuck Adapter and Chuck (Sold Separately)

1. Screw a chuck onto the threaded end of the chuck adapter.
2. Insert the connected chuck and adapter in the tool as though it were a standard SDS Plus® bit.
3. To remove the chuck, proceed as for removing a standard SDS Plus® bit.



WARNING: Never use standard chucks in the hammer drilling mode.

Consult your dealer for further information on the appropriate accessories.

Depth Rod (fig. 4)

TO ADJUST THE DEPTH ROD

1. Push in and hold the depth rod release button (j) on the side handle.
2. Move the depth rod (d) so the distance between the end of the rod and the end of the bit equals the desired drilling depth.
3. Release the button to lock rod into position. When drilling with the depth rod, stop when end of rod reaches surface of material.

OPERATION

Instructions for Use



WARNING: Always observe the safety instructions and applicable regulations.

Trigger Switch (fig. 1)

To start the rotary hammer, depress the trigger switch (a). To stop rotary hammer, release the switch.

NOTE: Use lower speeds for starting holes without a centerpunch, drilling in metal, plastics or ceramics, or driving screws. Higher speeds are better for drilling in masonry for maximum efficiency.

VARIABLE SPEED

The variable speed trigger switch (a) permits speed control. The farther the trigger switch is depressed, the higher the speed of the drill.

LOCK-ON BUTTON

 **WARNING:** Be sure to release the locking mechanism before disconnecting the plug from the power supply. Failure to do so will cause the hammerdrill to start immediately the next time it is plugged in. Damage or personal injury could result.

The lock-on button (i) is for use only when the rotary hammer is stationary, mounted in a drill press stand or for chipping applications.

Before using the tool each time, be sure that the lock-on button release mechanism is working freely. For continuous operation, press and hold the trigger switch (a); press the lock-on button (i); release the trigger switch and then release the lock-on button. The tool will continue to run.

To stop the tool in continuous operation, quickly press and release the trigger switch.

Proper Hand Position (fig. 3)

 **WARNING:** To reduce the risk of serious personal injury, **ALWAYS** use proper hand position as shown.

 **WARNING:** To reduce the risk of serious personal injury, **ALWAYS** hold securely in anticipation of a sudden reaction.

Proper hand position requires one hand on the side handle (c), with the other hand on the main handle (b).

Overload Clutch

If the drill bit becomes jammed or caught, the drive to the drill spindle is interrupted by the overload clutch. Because of the forces that occur as a result, always hold the machine securely with both hands and take a firm stance.

Drilling Tools

The machine is intended for hammerdrilling in concrete, brick and stone. It is also suitable for drilling without impact in wood, metal, ceramic and plastic.

Drilling (fig. 2)

 **WARNING:** To reduce the risk of serious personal injury, turn tool off and disconnect tool from power source before making any adjustments or removing/installing attachments or accessories.

 **WARNING:** To reduce the risk of personal injury, **ALWAYS** ensure workpiece is anchored or clamped firmly. If drilling thin material, use a wood "back-up" block to prevent damage to the material.

 **WARNING:** To reduce the risk of personal injury, **ALWAYS** operate the tool with the side handle properly installed and securely tightened. Failure to do so may result in the side handle slipping during tool operation and subsequent loss of control. Hold tool with both hands to maximize control.

Depress mode selector button (f) and turn the mode selector (g) to the drill bit symbol for drilling, to the hammer symbol for hammering or to the hammerdrill symbol for hammerdrilling.

DRILLING OPERATION

1. For WOOD, use twist bits, spade bits, power auger bits or hole saws. For METAL, use high-speed steel twist drill bits or hole saws. Use a cutting lubricant when drilling metals. The exceptions are cast iron and brass which should be drilled dry. For MASONRY, use carbide-tipped bits or masonry bits. A smooth, even flow of dust indicates the proper drilling rate.
2. Always apply pressure in a straight line with the bit. Use enough pressure to keep the drill bit biting, but do not push hard enough to stall the motor or deflect the bit.
3. Hold tool firmly with both hands to control the twisting action of the drill.

 **WARNING:** Drill may stall if overloaded causing a sudden twist. Always expect the stall. Grip the drill firmly with both hands to control the twisting action and avoid injury.

4. **IF DRILL STALLS**, it is usually because it is being overloaded. **RELEASE TRIGGER IMMEDIATELY**, remove drill bit from work, and determine cause of stalling. **DO NOT CLICK TRIGGER OFF AND ON IN AN ATTEMPT TO START A STALLED DRILL – THIS CAN DAMAGE THE DRILL.**

ENGLISH

5. To minimize stalling or breaking through the material, reduce pressure on drill and ease the bit through the last fractional part of the hole.
6. Keep the motor running when pulling the bit back out of a drilled hole. This will help prevent jamming.
7. With variable speed drills there is no need to center punch the point to be drilled. Use a slow speed to start the hole and accelerate by squeezing the trigger harder when the hole is deep enough to drill without the bit skipping out.

DRILLING IN METAL

An SDS Plus® to round shank adapter chuck is required. Ensure that tool is in drill-only mode. Start drilling with slow speed and increase to full power while applying firm pressure on the tool. A smooth even flow of metal chips indicates the proper drilling rate. Use a cutting lubricant when drilling metals. The exceptions are cast iron and brass which should be drilled dry.

NOTE: Large [7.9 mm to 12.7 mm (5/16" to 1/2")] holes in steel can be made easier if a pilot hole [4 mm to 4.8 mm (5/32" to 3/16")] is drilled first.

DRILLING IN WOOD

An SDS Plus® to round shank adapter chuck is required. Ensure that tool is in drill-only mode. Start drilling with slow speed and increase to full power while applying firm pressure on the tool. Holes in wood can be made with the same twist drills used for metal. These bits may overheat unless pulled out frequently to clear chips from the flutes. For larger holes, use spade bits, power auger bits, or hole saws. Work that is apt to splinter should be backed up with a block of wood.

Screwdriving (fig. 1)

1. Set the mode selector switch (g) to the rotary drilling position.
2. Select the direction of rotation.
3. Insert the special SDS Plus® screwdriving adaptor for use with hexagonal screwdriver bits.
4. Insert the appropriate screwdriver bit. When driving slotted head screws always use bits with a finder sleeve.
5. Gently press the variable speed switch (a) to prevent damage to the screw head. In reverse (LH) rotation the tool speed is automatically reduced for easy screw removal.
6. When the screw is flush with the workpiece, release the variable speed switch to prevent the screw head from penetrating into the workpiece.

Hammerdrill Operation

1. When drilling, use just enough force on the hammer to keep it from bouncing excessively or "rising" off the bit. Too much force will cause slower drilling speeds, overheating, and a lower drilling rate.
2. Drill straight, keeping the bit at a right angle to the work. Do not exert side pressure on the bit when drilling as this will cause clogging of the bit flutes and a slower drilling speed.
3. When drilling deep holes, if the hammer speed starts to drop off, pull the bit partially out of the hole with the tool still running to help clear debris from the hole.
4. For masonry, use carbide-tipped bits or masonry bits. A smooth even flow of dust indicates the proper drilling rate.

Chipping and Chiselling (D25013)

1. To switch from hammer drilling to chiselling, first insert the SDS Plus® chisel and check if it is properly locked.
2. When switching from hammer drilling mode to chiselling mode, turn the chisel to the desired position. If you find resistance during mode change, turn the chisel slightly to engage the spindle lock.



WARNING:

- The hammer is only for light chiselling applications.
- The forward/reverse switch must be in the forward position when chiselling



WARNING:

- Do not use this tool to mix or pump easily combustible or explosive fluids (benzine, alcohol, etc.).
- Do not mix or stir inflammable liquids labelled accordingly.

Various types of SDS Plus® drill bits and adaptors are available as an option.

Consult your dealer for further information on the appropriate accessories.

MAINTENANCE

Your DEWALT power tool has been designed to operate over a long period of time with a minimum of maintenance. Continuous satisfactory operation depends upon proper tool care and regular cleaning.



WARNING: To reduce the risk of injury, turn unit off and disconnect machine from power source before installing and removing accessories, before adjusting or changing set-ups or when making repairs. Be sure the trigger switch is in the OFF position. An accidental start-up can cause injury.

- This machine is not user-serviceable. Take the tool to an authorised DEWALT repair agent after approximately 40 hours of use. If problems occur before this time contact an authorised DEWALT repair agent.
- The tool will automatically switch off when the carbon brushes are worn.

Motor Brushes

DEWALT uses an advanced brush system which automatically stops the drill when the brushes wear out. This prevents serious damage to the motor. New brush assemblies are available at authorised DEWALT service centers. Always use identical replacement parts.



Lubrication

Your power tool requires no additional lubrication. Accessories and attachments used must be regularly lubricated around the SDS Plus® fitment.



Cleaning



WARNING: Blow dirt and dust out of the main housing with dry air as often as dirt is seen collecting in and around the air vents. Wear approved eye protection and approved dust mask when performing this procedure.



WARNING: Never use solvents or other harsh chemicals for cleaning the non-metallic parts of the tool. These chemicals may weaken the materials used in these parts. Use a cloth dampened only with water and mild soap. Never let any liquid get inside the tool; never immerse any part of the tool into a liquid.

Optional Accessories



WARNING: Since accessories, other than those offered by DEWALT, have not been tested with this product, use of such accessories with this tool could be hazardous. To reduce the risk of injury, only DEWALT, recommended accessories should be used with this product.

Various types of SDS Plus® drill bits and chisels are available as an option.

Consult your dealer for further information on the appropriate accessories.

Protecting the Environment



Separate collection. This product must not be disposed of with normal household waste.

Should you find one day that your DEWALT product needs replacement, or if it is of no further use to you, do not dispose of it with household waste. Make this product available for separate collection.



Separate collection of used products and packaging allows materials to be recycled and used again. Re-use of recycled materials helps prevent environmental pollution and reduces the demand for raw materials.

Local regulations may provide for separate collection of electrical products from the household, at municipal waste sites or by the retailer when you purchase a new product.

DEWALT provides a facility for the collection and recycling of DEWALT products once they have reached the end of their working life. To take advantage of this service please return your product to any authorised repair agent who will collect them on our behalf.

You can check the location of your nearest authorised repair agent by contacting your local DEWALT office at the address indicated in this manual. Alternatively, a list of authorised DEWALT repair agents and full details of our after-sales service and contacts are available on the Internet at: www.2helpU.com.

GUARANTEE

DeWALT is confident of the quality of its products and offers an outstanding guarantee for professional users of the product. This guarantee statement is in addition to and in no way prejudices your contractual rights as a professional user or your statutory rights as a private non-professional user. The guarantee is valid within the territories of the Member States of the European Union and the European Free Trade Area.

• 30 DAY NO RISK SATISFACTION GUARANTEE •

If you are not completely satisfied with the performance of your DeWALT tool, simply return it within 30 days, complete with all original components, as purchased, to the point of purchase, for a full refund or exchange. The product must have been subject to fair wear and tear and proof of purchase must be produced.

• ONE YEAR FREE SERVICE CONTRACT •

If you need maintenance or service for your DeWALT tool, in the 12 months following purchase, it will be undertaken free of charge at an authorised DeWALT repair agent. Proof of purchase must be produced. Includes labour. Excludes accessories and spare parts unless failed under warranty.

• ONE YEAR FULL WARRANTY •

If your DeWALT product becomes defective due to faulty materials or workmanship within 12 months from the date of purchase, DeWALT guarantees to replace all defective parts free of charge or – at our discretion – replace the unit free of charge provided that:

- The product has not been misused;
- The product has been subject to fair wear and tear;
- Repairs have not been attempted by unauthorised persons;
- Proof of purchase is produced;
- The product is returned complete with all original components.

If you wish to make a claim, contact your seller or check the location of your nearest authorised DeWALT repair agent in the DeWALT catalogue or contact your DeWALT office at the address indicated in this manual. A list of authorised DeWALT repair agents and full details of our after-sales service is available on the Internet at: www.2helpU.com.

Belgique et Luxembourg België en Luxemburg	Black & Decker - DEWALT Nieuwlandlaan 7, IZ Aarschot B156 B-3200 Aarschot	Tel: +32 (0)015 - 15 47 9211 Fax: +32 (0)015 - 15 47 9210 www.dewalt.be
Danmark	DEWALT Sluseholmen 2-4 2450 København SV	Tlf: 70201511 Fax: 70224910 www.dewalt.dk
Deutschland	DEWALT Richard-Klinger-Straße 65510 Idstein	Tel: 06126-21-1 Fax: 06126-21-2770 www.dewalt.de
Ελλάς	Black & Decker (Hellas) S.A. Στράβωνος 7 & Βουλιαγμένης 159 Γλυφάδα 16674, Αθήνα	Τηλ: (01) 8981-616 Φαξ: (01) 8983-570 Service: (01) 8982-630
España	DEWALT Parque de Negocios "Mas Blau" Edificio Muntadas, c/Bergadá, 1, Of. A6 08820 El Prat de Llobregat (Barcelona)	Tel: 934 797 400 Fax: 934 797 439 www.dewalt.es
France	DEWALT 5, allée des hêtres BP 30084, 69579 Limonest Cedex	Tel: 04 72 20 39 20 Fax: 04 72 20 39 00 www.dewalt.fr
Schweiz Suisse Svizzera	DEWALT In der Luberzen 40 8902 Urdorf	Tel: 01 - 730 67 47 Fax: 01 - 730 70 67 www.dewalt.ch
Ireland	DEWALT Calpe House Rock Hill Black Rock, Co. Dublin	Tel: 00353-2781800 Fax: 00353-2781811 www.dewalt.ie
Italia	DEWALT Viale Elvezia 2 20052 Monza (Mi)	Tel: 800-014353 Fax: 039-2387592 www.dewalt.it
Nederlands	Black & Decker - DEWALT Joulehof 12 4600 AB Bergen Op Zoom	Tel: 0164 283000 Fax: 0164 283100 www.dewalt.nl
Norge	DEWALT Postboks 4814, Nydalen 0422 Oslo	Tel: 22 90 99 00 Fax: 22 90 99 01 www.dewalt.no
Österreich	DEWALT Werkzeugevertriebs GmbH Erlaerstraße 165, Postfach 320,1231 Wien	Tel: 01 - 66116 - 0 Fax: 01 - 66116 - 14 www.dewalt.at
Portugal	DEWALT Rua Egas Moniz 173 João do Estoril, 2766-651 Estoril	Tel: 214 66 75 00 Fax: 214 66 75 75 www.dewalt.pt
Suomi	DEWALT Oy Tekniikantie 12 02150 Espoo, Finland	Puh: 010 400 430 Faksi: 0800 411 340 www.dewalt.fi
	DEWALT Oy Teknikvägen 12 02150 Esbo, Finland	Tel: 010 400 430 Fax: 0800 411 340 www.dewalt.fi
Sverige	DEWALT Box 94 431 22 Mölndal	Tel: 031 68 61 00 Fax: 031 68 60 08 www.dewalt.se
Türkiye	KALE Hırdavat ve Makina A.Ş. Defterdar Mah. Savaklar Cad. No:15 Edirnekapı / Eyüp / İSTANBUL 34050 TÜRKİYE	Tel: 0212 533 52 55 Faks: 0212 533 10 05 www.dewalt.com.tr
United Kingdom	DEWALT 210 Bath Road Slough, Berks SL1 3YD	Tel: 01753-56 70 55 Fax: 01753-57 21 12 www.dewalt.co.uk