

INSTRUCTION MANUAL

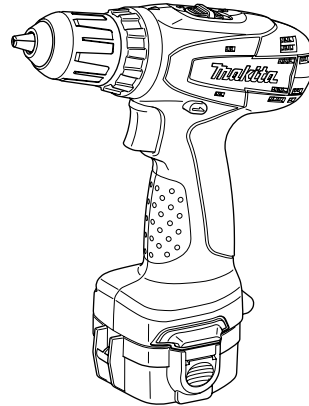

# Cordless Driver Drill

- 6261D
- 6271D
- 6281D
- 6381D
- 6391D



008685

**⚠WARNING:**

For your personal safety, READ and UNDERSTAND before using.  
SAVE THESE INSTRUCTIONS FOR FUTURE REFERENCE.

## ENGLISH (Original instructions)

# SPECIFICATIONS

Model		6261D	6271D	6281D	6381D	6391D
Capacities	Steel	10 mm	10 mm	10 mm	13 mm	13 mm
	Wood	21 mm	25 mm	25 mm	25 mm	36 mm
	Wood screw	5.1 mm x 38 mm	5.1 mm x 63 mm			6 mm x 75 mm
	Machine screw	6 mm				
No load speed (min <sup>-1</sup> )	High	0 - 1,300				
	Low	0 - 400				
Overall length		192 mm			200 mm	216 mm
Net weight		1.5 kg	1.5 kg	1.6 kg	1.7 kg	2.0 kg
Rated voltage		D.C. 9.6 V	D.C. 12 V	D.C. 14.4 V	D.C. 14.4 V	D.C.18V

- Due to our continuing programme of research and development, the specifications herein are subject to change without notice.
- Specifications and battery cartridge may differ from country to country.
- Weight, with battery cartridge, according to EPTA-Procedure 01/2003

END004-3

ENG901-1

## Symbols

The following show the symbols used for the equipment. Be sure that you understand their meaning before use.



- Read instruction manual.



- Only for EU countries  
Do not dispose of electric equipment together with household waste material! In observance of European Directive 2002/96/EC on waste electric and electronic equipment and its implementation in accordance with national law, electric equipment that have reached the end of their life must be collected separately and returned to an environmentally compatible recycling facility.

ENE034-1

## Intended use

The tool is intended for drilling and screw driving in wood, metal and plastic.

ENG103-3

## For European countries only

### Noise

The typical A-weighted noise level determined according to EN60745:

Sound pressure level ( $L_{pA}$ ) : 70 dB(A) or less  
Uncertainty (K) : 3 dB(A)

The noise level under working may exceed 80 dB(A)

### Wear ear protection

ENG202-3

### Vibration

The vibration total value (tri-axial vector sum) determined according to EN60745:

Work mode: drilling into metal  
Vibration emission ( $a_{h,D}$ ) : 2.5 m/s<sup>2</sup> or less  
Uncertainty (K) : 1.5 m/s<sup>2</sup>

- The declared vibration emission value has been measured in accordance with the standard test method and may be used for comparing one tool with another.
- The declared vibration emission value may also be used in a preliminary assessment of exposure.

## ⚠WARNING:

- The vibration emission during actual use of the power tool can differ from the declared emission value depending on the ways in which the tool is used.
- Be sure to identify safety measures to protect the operator that are based on an estimation of exposure in the actual conditions of use (taking account of all parts of the operating cycle such as the times when the tool is switched off and when it is running idle in addition to the trigger time).

ENH101-12

## EC Declaration of Conformity

**We Makita Corporation as the responsible manufacturer declare that the following Makita machine(s):**

Designation of Machine: Cordless Driver Drill  
Model No./ Type: 6261D,6271D,6281D,6381D,6391D  
are of series production and

### Conforms to the following European Directives:

98/37/EC until 28th December 2009 and then with  
2006/42/EC from 29th December 2009

And are manufactured in accordance with the following standards or standardised documents:  
EN60745

The technical documentation is kept by our authorised representative in Europe who is:

Makita International Europe Ltd,

Michigan, Drive, Tongwell,  
Milton Keynes, MK15 8JD, England

30th January 2009



000230

Tomoyasu Kato  
Director

Makita Corporation  
3-11-8, Sumiyoshi-cho,  
Anjo, Aichi, JAPAN

GEA006-2

## General Power Tool Safety

### Warnings

**⚠ WARNING** Read all safety warnings and all instructions. Failure to follow the warnings and instructions may result in electric shock, fire and/or serious injury.

### Save all warnings and instructions for future reference.

The term "power tool" in the warnings refers to your mains-operated (corded) power tool or battery-operated (cordless) power tool.

#### Work area safety

1. **Keep work area clean and well lit.** Cluttered or dark areas invite accidents.
2. **Do not operate power tools in explosive atmospheres, such as in the presence of flammable liquids, gases or dust.** Power tools create sparks which may ignite the dust or fumes.
3. **Keep children and bystanders away while operating a power tool.** Distractions can cause you to lose control.

#### Electrical safety

4. **Power tool plugs must match the outlet. Never modify the plug in any way. Do not use any adapter plugs with earthed (grounded) power tools.** Unmodified plugs and matching outlets will reduce risk of electric shock.
5. **Avoid body contact with earthed or grounded surfaces such as pipes, radiators, ranges and refrigerators.** There is an increased risk of electric shock if your body is earthed or grounded.
6. **Do not expose power tools to rain or wet conditions.** Water entering a power tool will increase the risk of electric shock.
7. **Do not abuse the cord. Never use the cord for carrying, pulling or unplugging the power tool. Keep cord away from heat, oil, sharp edges or moving parts.** Damaged or entangled cords

increase the risk of electric shock.

8. **When operating a power tool outdoors, use an extension cord suitable for outdoor use.** Use of a cord suitable for outdoor use reduces the risk of electric shock.
9. **If operating a power tool in a damp location is unavoidable, use a ground fault circuit interrupter (GFCI) protected supply.** Use of an GFCI reduces the risk of electric shock.

#### Personal safety

10. **Stay alert, watch what you are doing and use common sense when operating a power tool. Do not use a power tool while you are tired or under the influence of drugs, alcohol or medication.** A moment of inattention while operating power tools may result in serious personal injury.
11. **Use personal protective equipment. Always wear eye protection.** Protective equipment such as dust mask, non-skid safety shoes, hard hat, or hearing protection used for appropriate conditions will reduce personal injuries.
12. **Prevent unintentional starting. Ensure the switch is in the off-position before connecting to power source and/or battery pack, picking up or carrying the tool.** Carrying power tools with your finger on the switch or energising power tools that have the switch on invites accidents.
13. **Remove any adjusting key or wrench before turning the power tool on.** A wrench or a key left attached to a rotating part of the power tool may result in personal injury.
14. **Do not overreach. Keep proper footing and balance at all times.** This enables better control of the power tool in unexpected situations.
15. **Dress properly. Do not wear loose clothing or jewellery. Keep your hair, clothing, and gloves away from moving parts.** Loose clothes, jewellery or long hair can be caught in moving parts.
16. **If devices are provided for the connection of dust extraction and collection facilities, ensure these are connected and properly used.** Use of dust collection can reduce dust-related hazards.

#### Power tool use and care

17. **Do not force the power tool. Use the correct power tool for your application.** The correct power tool will do the job better and safer at the rate for which it was designed.
18. **Do not use the power tool if the switch does not turn it on and off.** Any power tool that cannot be controlled with the switch is dangerous and must be repaired.

19. **Disconnect the plug from the power source and/or the battery pack from the power tool before making any adjustments, changing accessories, or storing power tools.** Such preventive safety measures reduce the risk of starting the power tool accidentally.
20. **Store idle power tools out of the reach of children and do not allow persons unfamiliar with the power tool or these instructions to operate the power tool.** Power tools are dangerous in the hands of untrained users.
21. **Maintain power tools. Check for misalignment or binding of moving parts, breakage of parts and any other condition that may affect the power tool's operation. If damaged, have the power tool repaired before use.** Many accidents are caused by poorly maintained power tools.
22. **Keep cutting tools sharp and clean.** Properly maintained cutting tools with sharp cutting edges are less likely to bind and are easier to control.
23. **Use the power tool, accessories and tool bits etc. in accordance with these instructions, taking into account the working conditions and the work to be performed.** Use of the power tool for operations different from those intended could result in a hazardous situation.

#### **Battery tool use and care**

24. **Recharge only with the charger specified by the manufacturer.** A charger that is suitable for one type of battery pack may create a risk of fire when used with another battery pack.
25. **Use power tools only with specifically designated battery packs.** Use of any other battery packs may create a risk of injury and fire.
26. **When battery pack is not in use, keep it away from other metal objects, like paper clips, coins, keys, nails, screws or other small metal objects, that can make a connection from one terminal to another.** Shorting the battery terminals together may cause burns or a fire.
27. **Under abusive conditions, liquid may be ejected from the battery; avoid contact. If contact accidentally occurs, flush with water. If liquid contacts eyes, additionally seek medical help.** Liquid ejected from the battery may cause irritation or burns.

#### **Service**

28. **Have your power tool serviced by a qualified repair person using only identical replacement parts.** This will ensure that the safety of the power tool is maintained.
29. **Follow instruction for lubricating and changing accessories.**
30. **Keep handles dry, clean and free from oil and grease.**

## **SPECIFIC SAFETY RULES**

**DO NOT** let comfort or familiarity with product (gained from repeated use) replace strict adherence to drill safety rules. If you use this power tool unsafely or incorrectly, you can suffer serious personal injury.

1. **Use auxiliary handle(s), if supplied with the tool.** Loss of control can cause personal injury.
2. **Hold power tool by insulated gripping surfaces, when performing an operation where the cutting accessory may contact hidden wiring or its own cord.** Cutting accessory contacting a "live" wire may make exposed metal parts of the power tool "live" and could give the operator an electric shock.
3. **Always be sure you have a firm footing. Be sure no one is below when using the tool in high locations.**
4. **Hold the tool firmly.**
5. **Keep hands away from rotating parts.**
6. **Do not leave the tool running. Operate the tool only when hand-held.**
7. **Do not touch the drill bit or the workpiece immediately after operation; they may be extremely hot and could burn your skin.**
8. **Some material contains chemicals which may be toxic. Take caution to prevent dust inhalation and skin contact. Follow material supplier safety data.**

## **SAVE THESE INSTRUCTIONS.**

### **⚠WARNING:**

**MISUSE** or failure to follow the safety rules stated in this instruction manual may cause serious personal injury.

ENC004-1

## **IMPORTANT SAFETY INSTRUCTIONS**

### **FOR BATTERY CARTRIDGE**

1. **Before using battery cartridge, read all instructions and cautionary markings on (1) battery charger, (2) battery, and (3) product using battery.**
2. **Do not disassemble battery cartridge.**
3. **If operating time has become excessively shorter, stop operating immediately. It may result in a risk of overheating, possible burns and even an explosion.**

4. If electrolyte gets into your eyes, rinse them out with clear water and seek medical attention right away. It may result in loss of your eyesight.
5. Always cover the battery terminals with the battery cover when the battery cartridge is not used.
6. Do not short the battery cartridge:
  - (1) Do not touch the terminals with any conductive material.
  - (2) Avoid storing battery cartridge in a container with other metal objects such as nails, coins, etc.
  - (3) Do not expose battery cartridge to water or rain.  
A battery short can cause a large current flow, overheating, possible burns and even a breakdown.
7. Do not store the tool and battery cartridge in locations where the temperature may reach or exceed 50 ° C (122 ° F).
8. Do not incinerate the battery cartridge even if it is severely damaged or is completely worn out. The battery cartridge can explode in a fire.
9. Be careful not to drop or strike battery.

## SAVE THESE INSTRUCTIONS.

### Tips for maintaining maximum battery life

1. Charge the battery cartridge before completely discharged.  
Always stop tool operation and charge the battery cartridge when you notice less tool power.
2. Never recharge a fully charged battery cartridge.  
Overcharging shortens the battery service life.
3. Charge the battery cartridge with room temperature at 10 ° C - 40 ° C (50 ° F - 104 ° F). Let a hot battery cartridge cool down before charging it.
4. Charge the Nickel Metal Hydride battery cartridge when you do not use it for more than six months.

## FUNCTIONAL DESCRIPTION

### ⚠CAUTION:

- Always be sure that the tool is switched off and the battery cartridge is removed before adjusting or checking function on the tool.

### Installing or removing battery cartridge

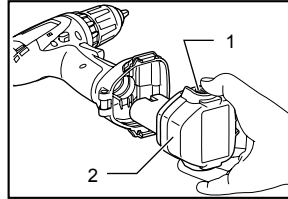

008686

1. Button
2. Battery cartridge

- Always switch off the tool before insertion or removal of the battery cartridge.
- To remove the battery cartridge, withdraw it from the tool while pressing the buttons on both sides of the cartridge.
- To insert the battery cartridge, align the tongue on the battery cartridge with the groove in the housing and slip it into place. Always insert it all the way until it locks in place with a little click. If not, it may accidentally fall out of the tool, causing injury to you or someone around you.
- Do not use force when inserting the battery cartridge. If the cartridge does not slide in easily, it is not being inserted correctly.

### Switch action

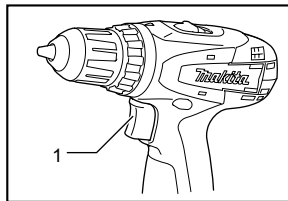

008687

1. Switch trigger

### ⚠CAUTION:

- Before inserting the battery cartridge into the tool, always check to see that the switch trigger actuates properly and returns to the "OFF" position when released.

To start the tool, simply pull the switch trigger. Tool speed is increased by increasing pressure on the switch trigger. Release the switch trigger to stop.

## Reversing switch action

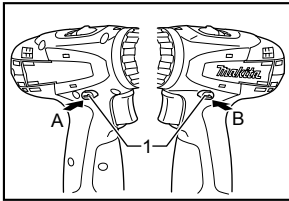

008688

1. Reversing switch lever

This tool has a reversing switch to change the direction of rotation. Depress the reversing switch lever from the A side for clockwise rotation or from the B side for counterclockwise rotation.

When the reversing switch lever is in the neutral position, the switch trigger cannot be pulled.

### ⚠ CAUTION:

- Always check the direction of rotation before operation.
- Use the reversing switch only after the tool comes to a complete stop. Changing the direction of rotation before the tool stops may damage the tool.
- When not operating the tool, always set the reversing switch lever to the neutral position.

## Speed change

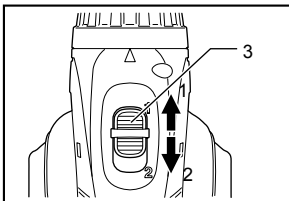

008689

1. Low speed
2. High speed
3. Speed change lever

To change the speed, first switch off the tool and then slide the speed change lever to the "2" side for high speed or "1" side for low speed. Be sure that the speed change lever is set to the correct position before operation. Use the right speed for your job.

### ⚠ CAUTION:

- Always set the speed change lever fully to the correct position. If you operate the tool with the speed change lever positioned halfway between the "1" side and "2" side, the tool may be damaged.
- Do not use the speed change lever while the tool is running. The tool may be damaged.

## Adjusting the fastening torque

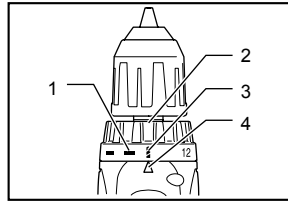

008690

1. Graduations
2. Adjusting ring
3. Drill marking
4. Pointer

The fastening torque can be adjusted in 17 steps by turning the adjusting ring so that its graduations are aligned with the pointer on the tool body. The fastening torque is minimum when the number 1 is aligned with the pointer, and maximum when the  $\otimes$  marking is aligned with the pointer.

The clutch will slip at various torque levels when set at the number 1 to 16. The clutch is designed not to slip at the  $\otimes$  marking.

Before actual operation, drive a trial screw into your material or a piece of duplicate material to determine which torque level is required for a particular application.

### NOTE:

- The adjusting ring does not lock when the pointer is positioned only halfway between the graduations.

## ASSEMBLY

### ⚠ CAUTION:

- Always be sure that the tool is switched off and the battery cartridge is removed before carrying out any work on the tool.

## Installing or removing driver bit or drill bit

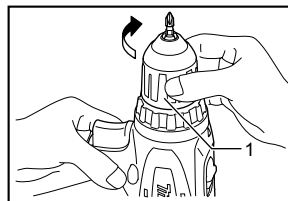

008691

1. Sleeve

Turn the sleeve counterclockwise to open the chuck jaws. Place the bit in the chuck as far as it will go. Turn the sleeve clockwise to tighten the chuck.

To remove the bit, turn the sleeve counterclockwise.

## OPERATION

### Screwdriving operation

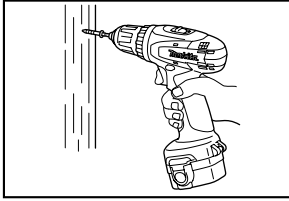

008692

#### ⚠CAUTION:

- Adjust the adjusting ring to the proper torque level for your work.

Place the point of the driver bit in the screw head and apply pressure to the tool. Start the tool slowly and then increase the speed gradually. Release the switch trigger as soon as the clutch cuts in.

#### ⚠CAUTION:

- Make sure that the driver bit is inserted straight in the screw head, or the screw and/or bit may be damaged.

#### NOTE:

- When driving wood screws, predrill pilot holes to make driving easier and to prevent splitting of the workpiece. See the chart.

Nominal diameter of wood screw (mm)	Recommended size of pilot hole (mm)
3.1	2.0 - 2.2
3.5	2.2 - 2.5
3.8	2.5 - 2.8
4.5	2.9 - 3.2
4.8	3.1 - 3.4
5.1	3.3 - 3.6
5.5	3.7 - 3.9
5.8	4.0 - 4.2
6.1	4.2 - 4.4

006421

### Drilling operation

First, turn the adjusting ring so that the pointer points to the  marking. Then proceed as follows.

#### Drilling in wood

When drilling in wood, the best results are obtained with wood drills equipped with a guide screw. The guide screw makes drilling easier by pulling the bit into the workpiece.

#### Drilling in metal

To prevent the bit from slipping when starting a hole, make an indentation with a center-punch and hammer at the point to be drilled. Place the point of the bit in the indentation and start drilling.

Use a cutting lubricant when drilling metals. The exceptions are iron and brass which should be drilled dry.

#### ⚠CAUTION:

- Pressing excessively on the tool will not speed up the drilling. In fact, this excessive pressure will only serve to damage the tip of your bit, decrease the tool performance and shorten the service life of the tool.
- There is a tremendous force exerted on the tool/bit at the time of hole break through. Hold the tool firmly and exert care when the bit begins to break through the workpiece.
- A stuck bit can be removed simply by setting the reversing switch to reverse rotation in order to back out. However, the tool may back out abruptly if you do not hold it firmly.
- Always secure small workpieces in a vise or similar hold-down device.
- If the tool is operated continuously until the battery cartridge has discharged, allow the tool to rest for 15 minutes before proceeding with a fresh battery.

## MAINTENANCE

#### ⚠CAUTION:

- Always be sure that the tool is switched off and the battery cartridge is removed before attempting to perform inspection or maintenance.

To maintain product SAFETY and RELIABILITY, repairs, any other maintenance or adjustment should be performed by Makita Authorized Service Centers, always using Makita replacement parts.

## ACCESSORIES

#### ⚠CAUTION:

- These accessories or attachments are recommended for use with your Makita tool specified in this manual. The use of any other accessories or attachments might present a risk of injury to persons. Only use accessory or attachment for its stated purpose.

If you need any assistance for more details regarding these accessories, ask your local Makita Service Center.

- Drill bits
- Screw bits
- Various type of Makita genuine batteries and chargers
- Rubber pad assembly
- Wool bonnet
- Foam polishing pad
- Plastic carrying case

Makita Corporation Anjo, Aichi, Japan