

# TITAN®

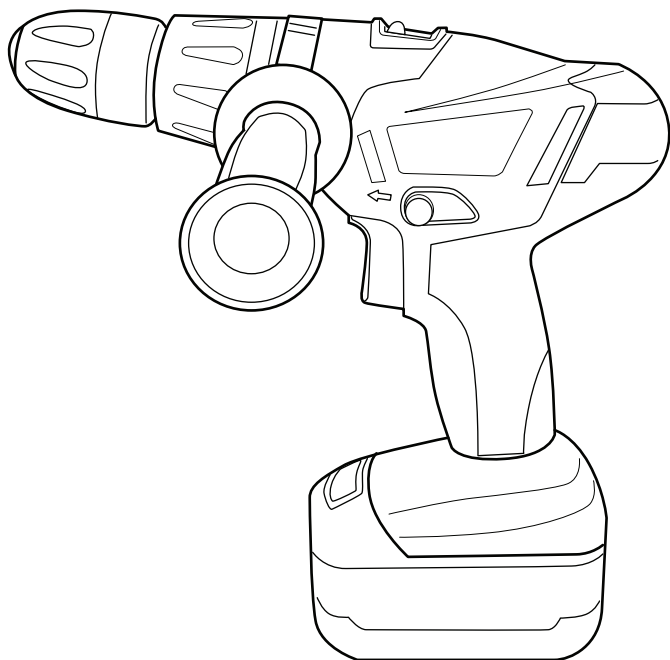

**24** **month**  
Manufacturer's  
Warranty

## **SAFETY AND OPERATING MANUAL**

Original instructions

**18V COMBI DRILL Li-ion**

**TTI270COM**

# TITAN®

**Congratulations on your purchase of a TITAN power tool from Titan Power Tools (UK) Ltd. We want you to continue getting the best performance from it so this handbook includes information on safety, handling and care. Please retain this handbook in case you need to refer to any of the information in the future.**

**Your TITAN power tool comes with a 24-month guarantee, so should it develop a fault within this period contact your retailer.**

## **GUARANTEE**

This **TITAN** product carries a guarantee of 24 months. If your product develops a fault within this period, you should, in the first instance contact the retailer where the item was purchased.

This guarantee specifically excludes losses caused due to:

- Fair wear and tear
- Misuse or abuse
- Lack of routine maintenance
- Failure of consumable items (such as batteries)
- Accidental damage
- Cosmetic damage
- Failure to follow manufacturer's guidelines
- Loss of use of the goods

This guarantee does not affect your statutory rights. This guarantee is only valid in the UK.

For any enquiries relating to the guarantee please refer to your retailer.

# GENERAL SAFETY INSTRUCTIONS



**WARNING! Read all safety warnings designated by the symbol  and all instructions.**



**WARNING! Read all safety warnings and all instructions.** Failure to follow the warnings and instructions may result in electric shock, fire and/or serious injury. **Save all warnings and instructions for future reference.**

The term "power tool" in the warnings refers to your mains-operated (corded) power tool or battery-operated (cordless) power tool.

## 1. Work area safety

- a. Keep work area clean and well lit.** Cluttered or dark areas invite accidents.
- b. Do not operate power tools in explosive atmospheres, such as in the presence of flammable liquids, gases or dust.** Power tools create sparks which may ignite the dust or fumes.
- c. Keep children and bystanders away while operating a power tool.** Distractions can cause you to lose control.

## 2. Electrical safety

- a. Power tool plugs must match the outlet. Never modify the plug in any way. Do not use any adapter plugs with earthed (grounded) power tools.** Unmodified plugs and matching outlets will reduce risk of electric shock.
- b. Avoid body contact with earthed or grounded surfaces, such as pipes, radiators, ranges and refrigerators.** There is an increased risk of electric shock if your body is earthed or grounded.
- c. Do not expose power tools to rain or wet conditions.** Water entering a power tool will increase the risk of electric shock.
- d. Do not abuse the cord. Never use the cord for carrying, pulling or unplugging the power tool. Keep cord away from heat, oil, sharp edges or moving parts.** Damaged or entangled cords increase the risk of electric shock.
- e. When operating a power tool outdoors, use an extension cord suitable for outdoor use.** Use of a cord suitable for outdoor use reduces the risk of electric shock.
- f. If operating a power tool in a damp location is unavoidable, use a residual current device (RCD) protected supply.** Use of an RCD reduces the risk of electric shock.

## 3. Personal safety

- a. Stay alert, watch what you are doing and use common sense when operating a power tool. Do not use a power tool while you are tired or under the influence of drugs, alcohol or medication.** A moment of inattention while operating power tools may result in serious personal injury.
- b. Use personal protective equipment. Always wear eye protection.** Protective equipment such as dust mask, non-skid safety shoes, hard hat, or hearing protection used for appropriate conditions will reduce personal injuries.
- c. Prevent unintentional starting. Ensure the switch is in the off-position before connecting to power source and/or battery pack, picking up or carrying the tool.** Carrying power tools with your finger on the switch or energising power tools that have the switch on invites accidents.

**d. Remove any adjusting key or wrench before turning the power tool on.** A wrench or a key left attached to a rotating part of the power tool may result in personal injury.

**e. Do not overreach. Keep proper footing and balance at all times.** This enables better control of the power tool in unexpected situations.

**f. Dress properly. Do not wear loose clothing or jewellery. Keep your hair, clothing and gloves away from moving parts.** Loose clothes, jewellery or long hair can be caught in moving parts.

**g. If devices are provided for the connection of dust extraction and collection facilities, ensure these are connected and properly used.** Use of dust collection can reduce dust-related hazards.

#### **4. Power tool use and care**

**a. Do not force the power tool. Use the correct power tool for your application.** The correct power tool will do the job better and safer at the rate for which it was designed.

**b. Do not use the power tool if the switch does not turn it on and off.** Any power tool that cannot be controlled with the switch is dangerous and must be repaired.

**c. Disconnect the plug from the power source and/or the battery pack from the power tool before making any adjustments, changing accessories, or storing power tools.** Such preventive safety measures reduce the risk of starting the power tool accidentally.

**d. Store idle power tools out of the reach of children and do not allow persons unfamiliar with the power tool or these instructions to operate the power tool.** Power tools are dangerous in the hands of untrained users.

**e. Maintain power tools. Check for misalignment or binding of moving parts, breakage of parts and any other condition that may affect the power tool's operation. If damaged, have the power tool repaired before use.** Many accidents are caused by poorly maintained power tools.

**f. Keep cutting tools sharp and clean.** Properly maintained cutting tools with sharp cutting edges are less likely to bind and are easier to control.

**g. Use the power tool, accessories and tool bits etc. in accordance with these instructions, taking into account the working conditions and the work to be performed.** Use of the power tool for operations different from those intended could result in a hazardous situation.

#### **5. Battery tool use and care**

**a. Recharge only with the charger specified by the manufacturer.**

A charger that is suitable for one type of battery pack may create a risk of fire when used with another battery pack.

**b. Use power tools only with specifically designated battery packs.**

Use of any other battery packs may create a risk of injury and fire.

**c. When battery pack is not in use, keep it away from other metal objects, like paper clips, coins, keys, nails, screws or other small metal objects, that can make a connection from one terminal to another.** Shorting the battery terminals together may cause burns or a fire.

**d. Under abusive conditions, liquid may be ejected from the battery; avoid contact. If contact accidentally occurs, flush with water. If liquid contacts eyes, additionally seek medical help.** Liquid ejected from the battery may cause irritation or burns.

## **6. Service**

**a. Have your power tool serviced by a qualified repair person using only identical replacement parts.** This will ensure that the safety of the power tool is maintained.

# **ADDITIONAL SAFETY INSTRUCTIONS FOR YOUR DRIVER DRILL**

## **FOR DRILL**

1. Wear ear protection with cordless drill. Exposure to noise can cause hearing loss.
2. Hold tool by insulated gripping surfaces when performing an operation where the drill bit tool may contact hidden wiring. Contact with a 'live' wire will also make exposed metal parts of the tool 'live' and shock the operator.
3. Remove the battery pack from the drill before carrying out adjustments.
4. Do not expose to rain or water.
5. Do not store the battery pack in temperatures over 40°C
6. Always charge the battery pack between temperatures 0°C to 30°C. Ideal charging temperature is 18°C to 24°C.
7. Only use the charger and the battery pack provided, no other battery is suitable.
8. Avoid short circuit of the battery pack connections (screws & nails).
9. Do not incinerate or burn the battery pack, it may explode.
10. Do not charge a damaged battery pack.
11. Replace any damaged supply cords on your charger.
12. Always disconnect the charger power supply before making or breaking the connections to the battery pack.
13. Your battery pack and charger will be warm during charging, this is normal.
14. When not in use, remove a charged battery pack from the charger.
15. Always remove the battery pack from the charger immediately after re-charging is completed.
16. Your drill and battery pack will be warm when working, this is normal.
17. Do not dispose of batteries in fire, or with household waste. Return exhausted batteries to your local collection or recycling point.
18. Always check walls, floors and ceilings for hidden power cables and pipes.
19. Accessories and metal parts can become very hot.

## **FOR CHARGER**

1. This appliance is not intended for use by persons (including children) with reduced physical, sensory or mental capabilities, or lack of experience and knowledge, unless they have been given supervision or instruction concerning use of the appliance by a person responsible for their safety. Children should be supervised to ensure that they do not play with the appliance.
2. Charger is double insulated for additional electrical safety.
3. Charger is for indoor use only.
4. If the charger supply cord is damaged, it must be replaced by the manufacturer, its service agent or similarly qualified persons in order to avoid a hazard.
5. Never charge damaged batteries as these can short circuit and over heat.

6. When the charger is in use it MUST be supervised , if there is any evidence of overheating then IMMEDIATELY disconnect the charger from the power supply.
7. If gas or smoke is emitted from the battery during charging switch off the power supply , and move to a well vented area to allow the fumes to vent to atmosphere. Caution is there is leaking liquid from the battery wear protective clothing, glasses and clothes as this can be acidic.
8. Always disconnect battery charger and remove battery from charger when the charging is complete.
9. Only use the battery charger specifically stated on the base of the battery.

## **FOR BATTERY**

1. Always remove the battery pack from the charger immediately after re-charging is completed.
2. When not in use, remove a charged battery pack from the charger.
3. Do not charge a damaged battery pack.
4. Do not charge non-rechargeable batteries.
5. Do not install the battery backwards so the polarity is reversed.
6. Do not connect the positive terminal and negative terminal of the battery to each other with any metal object (such as wire).
7. Do not carry or store battery together with necklaces, hairpins or other metal objects.
8. Do not pierce the battery with nails, strike the battery with a hammer, step on the battery or otherwise subject it to strong impacts or shocks.
9. Do not solder directly onto the battery.
10. Do not expose battery to water or salt water, or allow the battery to get wet.
11. Do not disassemble or modify the battery. The battery contains safety and protection devices, which, if damaged, may cause the battery to generate heat, explode or ignite. The protection circuit module provided with battery packs is not to be used as a substitute for a shut-off switch.
12. Do not place the battery in or near fire, on stoves or other high temperature locations. Do not place the battery in direct sunlight, or use or store the battery inside cars in hot weather. Heating the battery can damage the safety circuitry, which can cause additional heating, rupture or ignition of the battery. Using the battery in this manner may also result in a loss of performance and a shortened life expectancy.
13. Do not place the battery in microwave ovens, high-pressure containers or on induction cookware.
14. If you intend to store a battery for a period without use then store battery at room temperature (19°C to 25°C), charged to about 30 – 50% of capacity. When storing for very long periods boost-charge the battery once per year to prevent over discharge.
15. Always charge the battery in a temperature range of 0°C to 45°C and discharge in a temperature range of 0°C to 75°C.
16. The battery pack and charger will be warm during charging, this is normal.
17. Do not continue charging the battery if it does not recharge within the specified charging time. Doing so may cause the battery to become hot, explode or ignite. The temperature range over which the battery can be charged is 0°C to 45°C. Charging the battery at temperatures outside this range may cause severe damage to the battery or reduce battery life expectancy.
18. When the battery is worn out, insulate the terminals with adhesive tape or similar materials before disposal.
19. Do not dispose of batteries in fire, or with household waste. Return exhausted batteries to your local collection or recycling point.



**WARNING!** Some dust particles created by power sanding, sawing, grinding, drilling and other construction jobs contain chemicals known to cause cancer, birth defects or other reproductive harm. Some examples of these chemicals are:  
 Lead from lead-based paints.  
 Crystalline silica from bricks and cement and other masonry products.  
 Arsenic and chromium from chemically treated timber.

Your risk from these exposures varies, depending upon how often you do this type of work. To reduce your exposure to these chemicals:  
 Work in a well ventilated area.  
 Work with approved safety equipment, such as those dust masks that specially designed to filter out microscopic particles and use the dust extraction facility at all time.

## VIBRATION

The European Physical Agents (Vibration) Directive has been brought in to help reduce hand arm vibration syndrome injuries to power tool users. The directive requires power tool manufacturers and suppliers to provide indicative vibration test results to enable users to make informed decisions as to the period of time a power tool can be used safely on a daily basis and the choice of tool.

Further Advice can be found at [www.hse.gov.uk](http://www.hse.gov.uk)

Vibration total values (triax vector sum) determined according to EN 60745:	
Drilling	Vibration for drilling into metal $a_{h,D} = 2.336\text{m/s}^2$
	Vibration for impact drilling into concrete $a_{h,ID} = 10.721\text{m/s}^2$
	Uncertainty $K = 1.5\text{m/s}^2$

The declared vibration emission value should be used as a minimum level and should be used with the current guidance on vibration.  
 Calculating the actual period of the actual period off use can be difficult and the HSE website has further information.

The declared vibration emission been measured in accordance with a standardised test stated above and may be used to compare one tool with another.  
 The declared vibration emission value may also be used in a preliminary assessment of exposure.



**Warning:** The vibration emission value during actual use of the power tool can differ from the declared value depending on the ways in which the tool is used dependant on the following examples and other variations on how the tool is used:

- How the tool is used and the materials being drilled.
- The tool being in good condition and well maintained
- The use the correct accessory for the tool and ensuring it is sharp and in good condition.
- The tightness of the grip on the handles.
- And the tool is being used as intended by its design and these instructions.

## **This tool may cause hand-arm vibration syndrome if its use is not adequately managed**



**Warning:** identify safety measures to protect the operator that are based on an estimation of exposure in the actual conditions of use (taking account of all parts of the operating cycle such as the times when the tool is switched off and when it is running idle in addition to the trigger time). Note The use of other tools will reduce the users' total working period on this tool.

Helping to minimise your vibration exposure risk.

Maintain this tool in accordance with these instructions and keep well lubricated (where appropriate)

Avoid using tools in temperatures of 10°C or less

Plan your work schedule to spread any high vibration tool use across a number of days.

Health Surveillance

All employees should be part of an employer's health surveillance scheme to help identify any vibration related diseases at an early stage, prevent disease progression and help employees stay in work.

### **Double insulation:**

The charger is double insulated. This means that all the external metal parts are electrically insulated from the mains power supply. This is done by placing insulation barriers between the electrical and mechanical components making it unnecessary for the tool to be earthed.

### **Important note:**

Be sure the supply is the same as the voltage given on the rating plate for the charger. The charger is fitted with a two-core cable and plug.

Remove the mains plug from socket and battery from the drill before carrying out any adjustment or servicing.

## **SYMBOLS**



To reduce the risk of injury, user must read instruction manual



Warning



Waste electrical products should not be disposed of with household waste. Please recycle where facilities exist. Check with your Local Authority or retailer for recycling advice.



Wear ear protection





Wear eye protection



Wear dust mask



Double insulation



Conformity to CE directive



Always charge the battery pack between temperatures 0°C to 30°C



Indoor use only



Do not expose to rain or water



Do not burn



1h

1hour charging time



Before charging, read the instructions

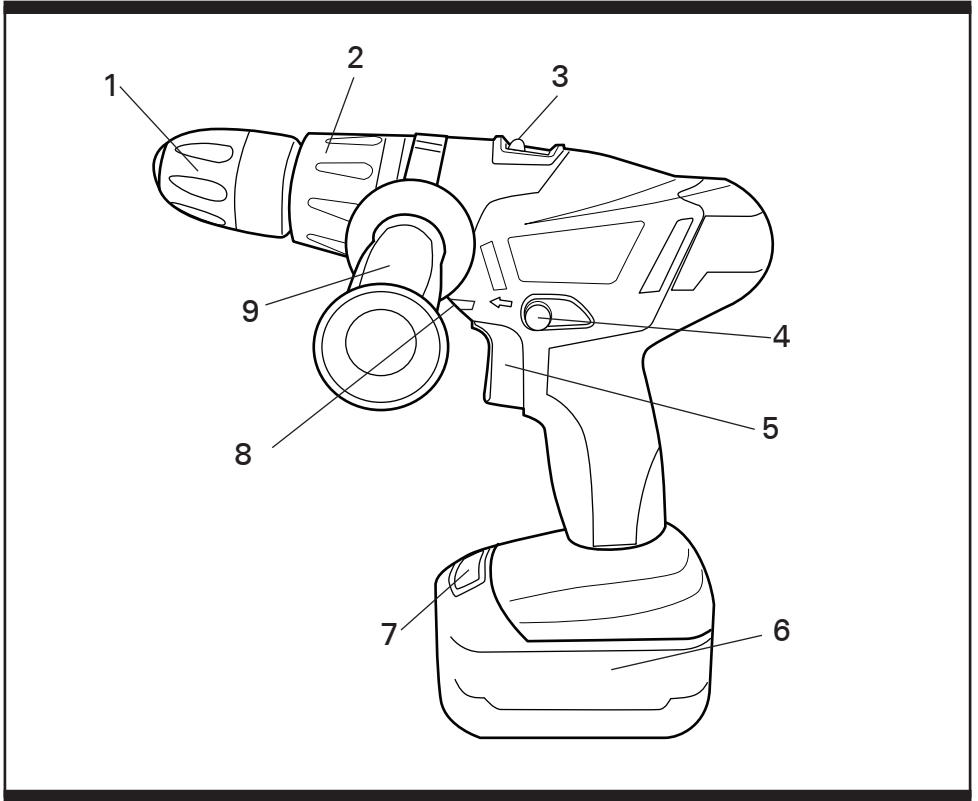

---

**1 Keyless chuck**

---

**2 Torque ring with drill/hammer selector**

---

**3 Gear selector**

---

**4 Forward and reverse control**

---

**5 ON/OFF switch with variable speed control**

---

**6 Battery pack**

---

**7 Battery pack release button**

---

**8 LED light**

---

**9 Auxiliary handle**

---

## TECHNICAL DATA

Voltage:	18V $\text{---}$
Speed:	0-400/min / 0-1300/min
Maximum capacity of the chuck:	13mm
Drilling Capacity:	
Wood:	$\phi$ 22mm
Steel:	$\phi$ 10mm
Masonry:	$\phi$ 13mm
Machine weight:	2.5kg
Charger:	
Charger model:	TTB304CHR
Input:	220-240V~ 50/60Hz 78W
Output:	14.4V-18V $\text{---}$ 3.0A
Battery:	
Battery model:	TTI300BAT

## NOISE DATA

A weighted sound pressure	84.5dB(A) / KpA: 3dB(A)
A weighted sound power	95.5dB(A) / KwA: 3dB(A)
Wear ear protection when sound pressure is over	80dB

## ACCESSORIES

<b>Auxiliary handle</b>	<b>1pc</b>
<b>1.3Ah Li-ion battery pack</b>	<b>2pcs</b>
<b>Double ended screwdriver bit</b>	<b>1pc</b>
<b>1.5 hour charger</b>	<b>1pc</b>

# OPERATIONS INSTRUCTIONS



**Note:** Before using the tool, read the instruction book carefully.

## INTENDED USE

This cordless impact drill driver shall be used for drilling metal or wood or similar materials, and occasionally for impact drilling on masonry or similar materials. Other uses for the tool will lead to the damage of the tool and a series of dangers to the operator. This tool is intended for DIY home use, or occasional professional use.

## BEFORE USING YOUR CORDLESS DRILL

Your battery pack is UNCHARGED and you must charge once before use. When you charge the new battery or one which has not been used for long periods of time, it may not reach full charge until after you have discharged it fully in use and recharge it several times.



**WARNING:** The charger and battery pack are specifically designed to work together so do not attempt to use any other devices. Never insert or allow metallic objects into your charger or battery pack connections because an electrical failure and hazard will occur.

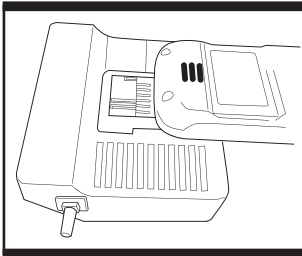

**Fig. 1**

## 1. TO CHARGE THE BATTERY PACK (Fig. 1)

Insert the charger plug into a suitable mains socket. The power indicator (green) will illuminate. Insert the battery pack into the charger. Then green light will switch off while the red light will illuminate to indicate that charging is taking place. When fully charged, the red light will go out while the green light switches back on. Unplug the charger and remove the battery pack.



**Warning:** When battery charge runs out after continuously use or exposure to direct sunlight or heat, allow time for the tool to cool down before re-charging to achieve the full charge.

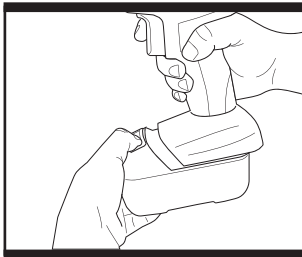

**Fig. 2**

## 2. TO REMOVE OR INSTALL BATTERY PACK (Fig. 2)

To remove the battery pack(6) from the tool, firmly press and hold in the battery pack release button(5) and slide the battery pack out of the tool. To install the battery pack, align raised rib on battery pack with groove inside tool, slide the battery pack fully onto the tool until the battery pack “clicks” into position. Make sure the release button on battery pack snaps in place and the battery pack is secured in tool before beginning operation.

# OPERATIONS INSTRUCTIONS

## 1. ON/OFF SWITCH & VARIABLE SPEED CONTROL (Fig. 3)

Depress to start and release to stop your drill. The on/off switch is fitted with a brake function which stops your chuck immediately when you quickly release the switch. The variable speed control enables you to select the best speed for a particular job. The further you squeeze the control the faster the drill will operate.

 **Warning:** Do not operate for long periods at low speed because excess heat will be produced internally.

## 2. FORWARD/REVERSE SWITCH & SWITCH LOCK (Fig. 3)

The switch trigger can be locked in the OFF position. This helps to reduce the possibility of accidental starting when not in use. To lock the switch trigger, place the direction of rotation selector in the centre position.

For drilling and screw driving use forward rotation (lever is moved to the left). Only use reverse rotation (lever is moved to the right) to remove screws or release a jammed drill bit.

 **Warning:** Never change the direction of rotation when the chuck is rotating. Wait until it has stopped.

## 3. TWO-SPEED GEAR CONTROL (Fig. 4)

The drill has a two-speed gear control designed for drilling or driving at low (mark is 1) or high (mark is 2) speeds. A slide switch (2) is located on top of the drill to select either low or high speed. When using the drill in the low speed range, the speed will decrease and the drill will have greater power and torque. When using the drill in the high speed range, the speed will increase and the drill will have less power and torque.

 **WARNING:** To prevent gear damage, always allow the chuck to come to a complete stop before changing the direction of rotation or the two-speed gear train.

## 4. INSERTING/REMOVING A BIT (Fig. 5)

 **WARNING!** Remove the battery pack and set the forward / reverse control to the locked centre position when installing or removing bits to prevent accidental starting.

Your tool is fitted with a keyless chuck for greater convenience, a chuck key is not needed to secure a bit in the chuck. The chuck also has a locking device to prevent bits loosening in use. To insert / remove a drill bit or other accessories, pull back the rear sleeve of chuck and grasp it with one hand, use your other hand to rotate the front sleeve of chuck in an anti-clockwise direction. Open the chuck jaws sufficiently so as to fit the desired accessory.

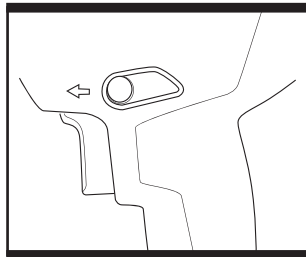

Fig. 3

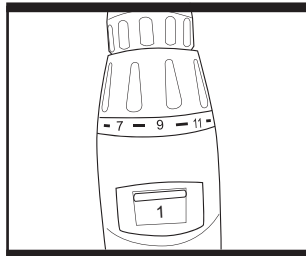

Fig. 4

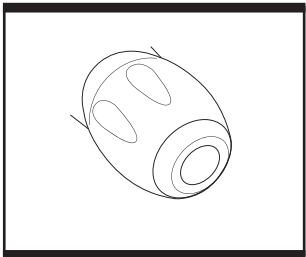
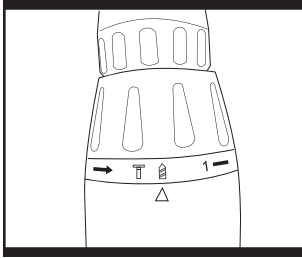

Fig. 5



**Fig. 6**

Insert the drill bit or other accessory into the chuck and tighten securely by holding the rear sleeve of the chuck and rotating the front sleeve in the clockwise direction. Push the rear sleeve forward to lock the chuck to prevent the bit from coming loose in use.

## 5. TORQUE ADJUSTMENT (Fig. 6)

(Screw driving force of your drill driver)

The torque is adjusted by rotating the torque adjustment ring. The torque is greater when the torque adjustment ring is set on a higher setting. The torque is less when the torque adjustment ring is set on a lower setting.

Make the setting as follows:

1 low setting, e. g., small screws, soft materials.

20 high setting, e. g., large screws, hard materials.

 for heavy drilling.

 for impact drilling on masonry.

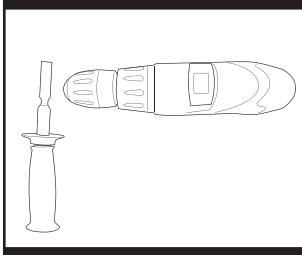

**Fig. 7**

## 6. INSTALLING THE AUXILIARY HANDLE (Fig. 7 & Fig. 8)

(Fig. 7 & Fig. 8)

Loosen the handgrip anti-clockwise then slide the handle on the head of the drill. Rotate the handgrip clockwise to clamp the handle and tighten fully.

**Note:** Use the auxiliary handle where possible to gain extra control and to prevent fatigue. Hold the tool firmly to control the twisting of the tool.

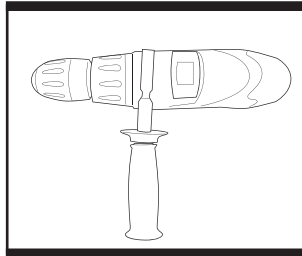

**Fig. 8**

## 7. DRILLING

When drilling hard smooth surfaces, use a centre punch to mark the desired hole location. This will prevent the drill bit from slipping off centre as the hole is started. Hold the tool firmly and place the tip of the bit at the point to be drilled. Depress the switch trigger to start the tool. Move the drill bit into the work-piece, applying only enough pressure to keep the bit drilling. Do not force or apply side pressure to elongate a hole.

 **WARNING:** When drilling in metal, only use HSS drill bits in good condition. Always use a magnetic bit holder when using short screwdriver bits. When screw-driving, apply a small quantity of liquid soap or similar to the screw threads to ease insertion.

If you want to activate the drill function (For drilling metal, wood or plastic), turn the torque adjustment ring on the drill position. If you want to activate the impact function (For masonry or concrete), turn the torque adjustment ring on the hammer position.

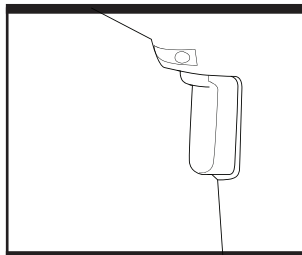

**Fig. 9**

## 8. USING THE LED WORK LIGHT (Fig. 9)

The LED work light allows you to keep a clear view under less illuminated circumstances. To turn on the light simply press the on/off switch. When you release the on/off switch, the light will be off.

 **WARNING:** The light is a focussed beam and should never be pointed directly into the eyes of people or animal.

## **TROUBLESHOOTING**

### **1. WHY DOES THE DRILL NOT TURN ON WHEN YOU PRESS THE SWITCH?**

The forward and reverse switch, which is on top of the trigger, is positioned in the lock function.

Unlock the forward and reverse switch putting it into the required rotation position. Push the trigger and the drill will start to rotate.

### **2. THE DRILL STOPS BEFORE THE SCREW IS COMPLETELY TIGHTENED. WHY?**

Verify the torque position of the variable clutch, you can find the variable clutch between the chuck and the drill body. Position 1 is the lowest torque (screw driving force) and position 20 is the highest torque (screw driving force). The position on the drilling mark is for drill operation. Regulate the variable clutch to a higher position to reach the best result. Recharge battery if the drill suddenly stalls or rotates intermittently.

### **3. I CANNOT FIT THE BATTERY INTO THE BATTERY CHARGER. WHY?**

The battery can be inserted into the charger only in one direction. Turn the battery around until it can be inserted into the slot, the red LED light should turn on when the battery is charging.

### **4. REASONS FOR DIFFERENT CHARGING TIMES.**

Your charge time can be affected by many reasons, which are not defects in your product. If the battery pack is only partly discharged it may be re-charged in less than 1 hour. If the battery pack and ambient temperature are very cold then recharging may take 1 to 1-1/2 hours. If the battery pack is very hot it will not re-charge because the internal temperature safety cutout will prevent it.

If the battery pack is very hot you must remove your battery pack from the charger and allow your battery pack to cool first to ambient temperature and then recharging can be started. If you charge a second battery pack immediately after the first then the charger can be overheated. Always allow at least 15 minutes rest between battery pack charging.

## **5. REASONS FOR DIFFERENT BATTERY PACK WORKING TIMES.**

Charging time issues, as above, and having not used a battery pack for a prolonged time will reduce the working life of the battery pack.

This can be corrected after several charge and discharge operations by charging & working with your drill. Heavy working conditions such as large screws into hard wood will use up the battery pack energy faster than lighter working conditions. Do not re-charge your battery pack below 0°C and above 30°C as this will affect performance.

## **DISPOSAL OF AN EXHAUSTED BATTERY PACK**

To preserve natural resources, please recycle or dispose of the battery pack properly. This battery pack contains Li-ion batteries. Consult your local waste authority for information regarding available recycling and/ or disposal options. Discharge your battery pack by operating your drill, then remove the battery pack from the drill housing and cover the battery pack connections with heavy duty adhesive tape to prevent short circuit and energy discharge.

Do not attempt to open or remove any of the components.



## **MAINTENANCE**

**Remove the battery from the tool plug from the socket before carrying out any adjustment, servicing or maintenance.**

Your power tool requires no additional lubrication or maintenance. There are no user serviceable parts in your power tool. Never use water or chemical cleaners to clean your power tool. Wipe clean with a dry cloth. Always store your power tool in a dry place. Keep the motor ventilation slots clean. Keep all working controls free of dust.

Occasionally you may see sparks through the ventilation slots. This is normal.

If the supply cord of the charger is damaged, it must be replaced by the manufacturer, its service agent or similarly qualified persons in order to avoid a hazard.

## **ENVIRONMENTAL PROTECTION**



Waste electrical products should not be disposed of with household waste. Please recycle where facilities exist. Check with your Local Authority or retailer for recycling advice. For further information visit [www.recyclemore.co.uk](http://www.recyclemore.co.uk)

## UK PLUG REPLACEMENT

The fuse in the main plug of your charger should always be replaced with one of identical rating.

Check the voltage given on your charger matches the supply voltage.

The charger is supplied with a fitted plug, however if you should need to fit a new plug follows the instruction below.

### IMPORTANT

The wire in the mains lead are coloured in accordance with the following code:

**Blue ---Neutral**

**Brown ---Live**

The wire that is coloured **blue** must be connected to the terminal that is marked with the letter **N**. The wire that is coloured **brown** must be connected to the terminal that is marked with the letter **L**.

A 13 AMP (BS1363 or BS1363/A) plug must be used and a 5 AMP fuse must be fitted.

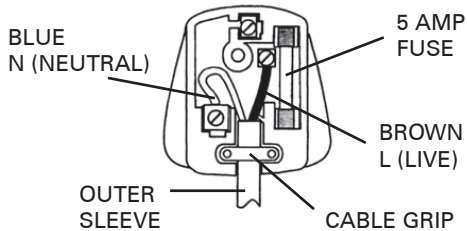

# TITAN®

## Declaration of Conformity

We, Importer  
**Titan Power Tools (UK) Ltd**  
**Trade house, Mead Avenue, BA22 8RT**

Declare that the product:  
**Designation: 18V OCMBI DRILL Li-ion**  
**Model: TTI270COM**

Complies with the following Directives:  
**2004/108/EC** Electromagnetic Compatibility Directive,  
**2006/42/EC** Machinery Directive  
**2006/95/EC** Low Voltage Directive,  
**2002/95/EC** Restrictions of the Use of Certain Hazardous Substances in Electrical and Electronic Equipment  
**2002/96/EC and 2003/108/EC** Waste Electrical and Electronic Equipment (WEEE),

Standards and technical specifications referred to:

**EN 60745-1: 2009**  
**EN 60745-2-1: 2003+A11: 2007+A12: 2009+A1: 2009**  
**EN 60745-2-2: 2003+A11: 2007+A12: 2009+A1: 2009**  
**EN 60335-1:2002+A1:2004+A11:2004+A12:2006+A2:2006+A13:2008**  
**EN 60335-2-29 :2004**  
**EN 55014-1: 2006+A1: 2009**  
**EN 55014-2:1997+A1: 2001+A2: 2008**  
**EN 61000-3-2: 2006**  
**EN 61000-3-3: 2008**

### Authorised signatory and technical file holder

Date: 07/07/2010

Signature: P.C. Harries

Name / title: Peter Harries / Quality Manager

Titan Power Tools (UK)Ltd. Trade House , Mead Avenue ,BA22 8RT



**18V COMBI DRILL Li-ion**

**TTI270COM**