

# TP5000 Si Range

*Electronic 5/2 day programmable room thermostat  
Mains, Battery and RF versions*



Certification Mark

---

**GB** Installation and User Instructions

---

*Danfoss*



# Index

Index

## ***Installation Instructions*** **3-14**

---

Product Specification	3
Installation	4
Cable Access and Wiring	5-8
Installer Advanced Programming Options	8-14

## ***User Instructions*** **15-31**

---

What is a Programmable Room Thermostat	15
Preset programmes	16-17
Setting Date and Time	18-19
Changing Preset Programmes	19-22
User overrides	22-25
Advanced User Programming Options	25-28
Overview of Installer Selectable Features	29-30
Setting References	31

# Installation Instructions



**Please Note:**

*This product should only be installed by a qualified electrician or competent heating installer and should be in accordance with the current edition of the IEE wiring regulations.*

## Product Specification

Thermostat features	TP5000 Si	TP5000-RF Si	TP5000M Si	TP5000M 24 Si
Power supply	2 x AA/MN1500/LR alkaline cells		230V, ±15%, 50Hz	24V, ±15%, 50Hz
Memory back-up	Retained for life of product			
Temperature Range Sensing	5-30°C			
Factory set calendar clock	Automatic summer/winter time change			
Switching action of output relay	3(1)A, 10-230V	N/A	3(1)A, 10-230V, Type 1B	
Transmission frequency (RF models)	N/A	433.92MHz	N/A	N/A
Transmission range (RF models)	N/A	30m max.	N/A	N/A
Remote sensor inputs (A models only)	Can be set by installer for remote temperature sensor, limit sensor, window contact or telephone activated switch contacts			
Dimensions (mm)	110 wide, 88 high, 28 deep			
Design standard	EN60730-2-9 (EN300220 for RF)			
Rated impulse voltage	2.5kV			
Ball hardness test	75°C			
Control pollution situation	Degree 2			
Temperature accuracy	±1°C			
Time accuracy	±1 minute per month			

**Important note RF products:** Ensure that there are no large metal objects, such as boiler cases or other large appliances, in line of sight between the transmitter and receiver as these will prevent communication between thermostat and receiver.

- ❑ First, remove the wallplate from the back of the unit.

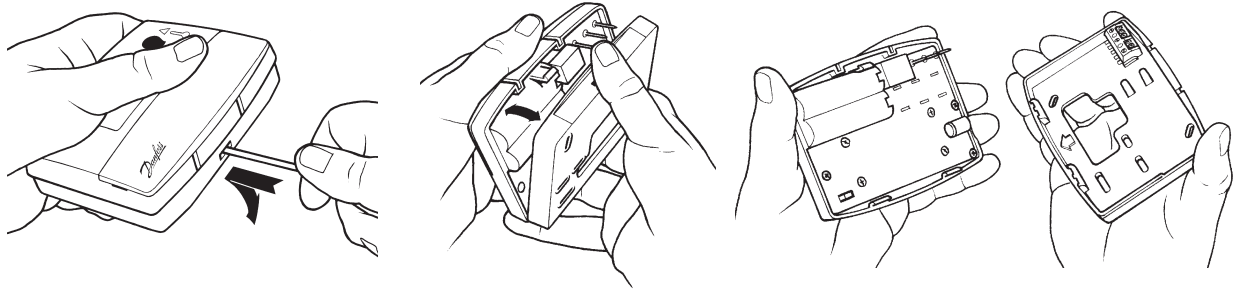

- ❑ From the top left hand corner of the wallplate, there must be clearances of at least 15mm to the right, 15mm to the left, 30mm above and 100mm below in order to mount the plug-in module.

❑ **Thermostat and Remote Room Sensor:**

Fix at a height of approximately 1.5m from the floor, away from draughts or heat sources such as radiators, open fires or direct sunlight.

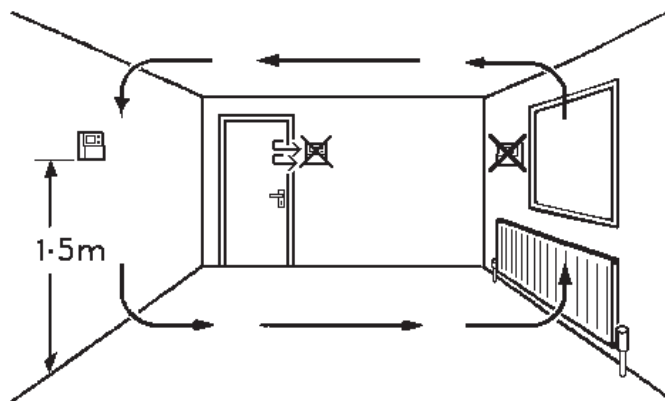

- ❑ Prior to mounting the unit the 2 DIL switches on the rear of the unit have to be moved to the required position. The factory presets are shown below.

Sw. No.	OFF	ON	
1 Keyboard disabled	<div style="display: inline-block; width: 20px; height: 10px; border: 1px solid black; background-color: white;"></div>	<div style="display: inline-block; width: 20px; height: 10px; border: 1px solid black; background-color: black;"></div>	Keyboard enabled
2 Reset disabled	<div style="display: inline-block; width: 20px; height: 10px; border: 1px solid black; background-color: white;"></div>	<div style="display: inline-block; width: 20px; height: 10px; border: 1px solid black; background-color: black;"></div>	Reset enabled

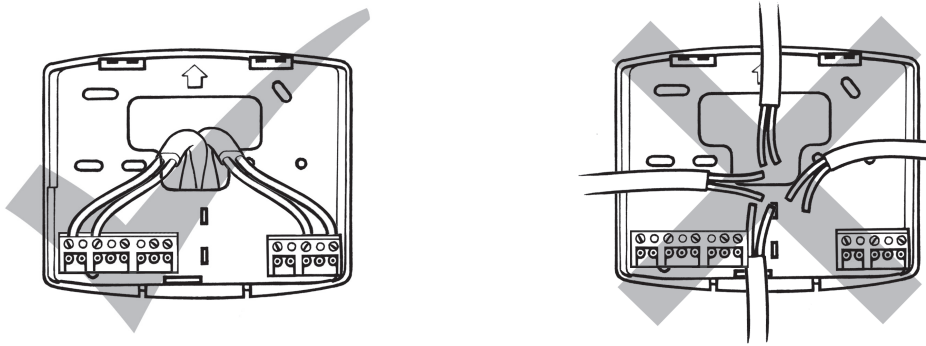

## Battery Installation

When installing the batteries in the TP5000 Si and TP5000 Si RF please ensure that the correct polarity is observed as per the markings on the inside of the battery compartment.

**IMPORTANT:** After installing the batteries press and release the **RESET** button to start the unit. The display may appear blank until this is done. Once the button is released the display will appear. All date, time, programming and override settings are maintained for the life of the product.

## Wiring

### Power Supply Connections

#### M 230V Models

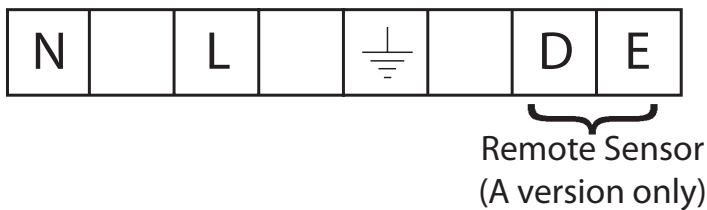

#### M 24V Models

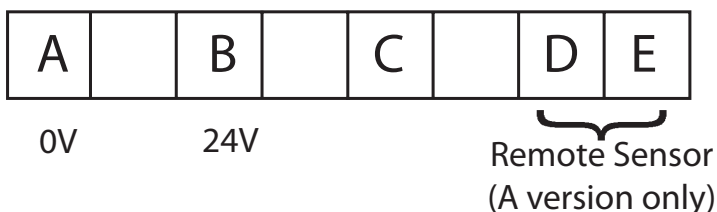

### Output Connections, all hard wired models

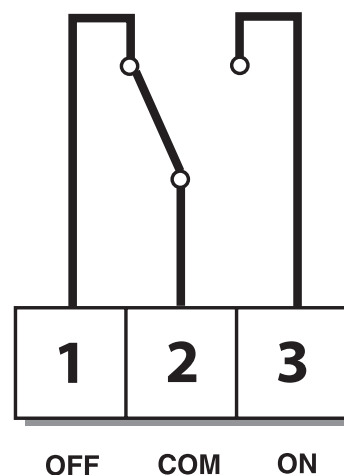

Some existing thermostats will have a Neutral and/or Earth wire connected. These are not required by the battery powered versions of the TP5000 Si and must NOT be connected to any battery powered TP5000 Si terminals. Instead they should be made electrically safe and coiled in the recess at the back of the TP5000 Si.

**Models with remote sensor inputs**

The TP5000A Si, TP5000A-RF Si and TP5000MA Si incorporate an input which can be used to connect one of the following:

- 1) remote room temperature sensor (sold as accessory).
- 2) limit sensor, for example, floor temperature sensor (sold as accessory).
- 3) window contacts, card reader contacts or teleswitch contacts.

See **Installer Advanced Programming Options** for set-up instructions.

**Models with remote sensor inputs**

Terminal block for remote control/sensing is located on the circuit board above the battery compartment.

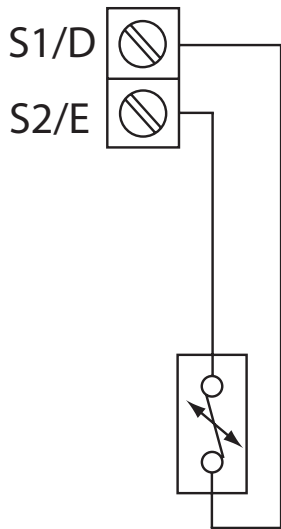
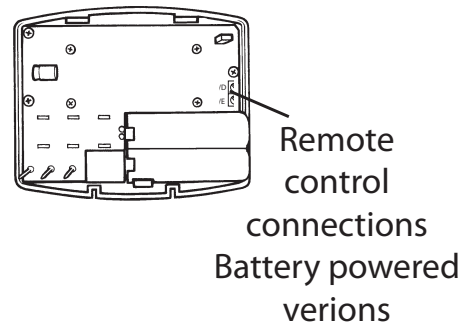

Configured for remote room sensor or limit sensor

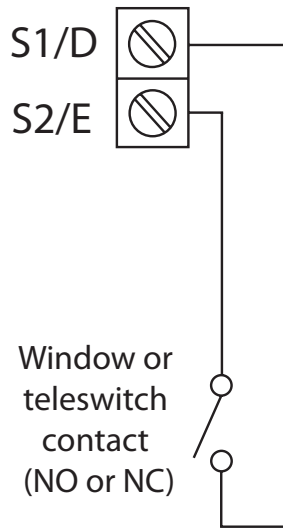

Configured for window contact or other contact such as teleswitch

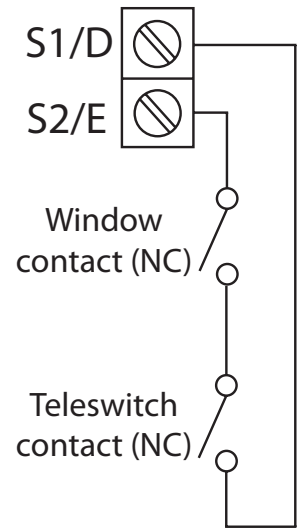

Configured for window contact and other contact such as teleswitch

**Note:**

Battery powered versions use S1 and S2.  
Mains powered versions use D and E.

# RX Receiver Wiring (RF models only)

## RX1

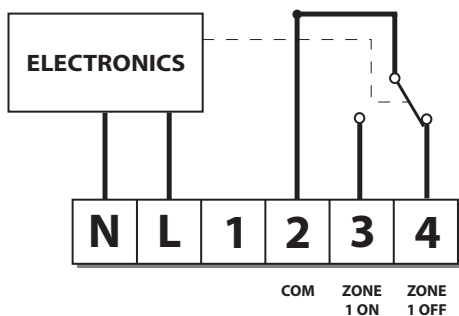

## RX2 & RX3

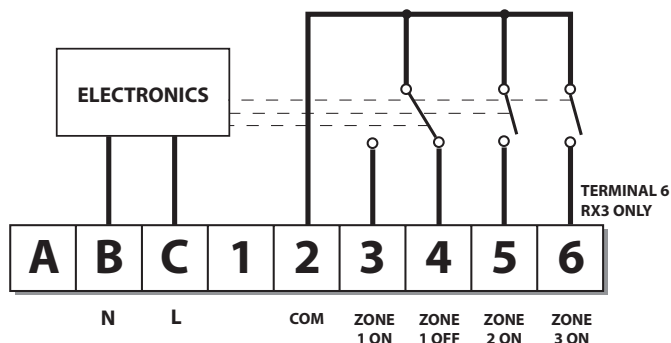

- 1) For mains voltage operated systems link terminal 2 to mains live supply.
- 2) Power supply to unit must not be switched by timeswitch.

## **IMPORTANT**

To ensure that the factory programmes are set and the micro-computer is operating correctly it is essential that you press and hold the RESET button before you begin any commissioning or programming.

## Commissioning (RF models only)

If the thermostat and the receiver have been supplied together in a combined pack, the units have been paired in the factory and no commissioning is required (RX1 only).

To make the RX receiver learn the thermostat's signal, follow steps 1-5 below.

### Step 1

**TP5000-RF Si** - Reset the unit by pressing the recessed reset button.

### Step 2

Press and hold **V and +** buttons for 3 seconds (TP5000 RF Si now transmits unique signal continuously for 3 minutes).

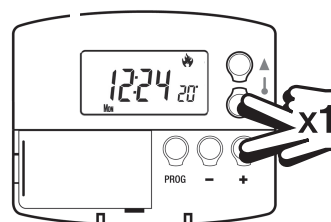



**Step 3**

**RX1** - Press and hold buttons **PROG** and **CH1** for 3 seconds until green light flashes once.

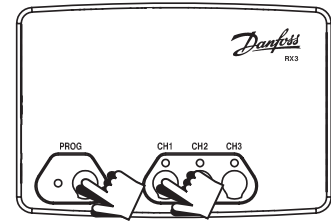

**Step 4**

**RX2 (if applicable)**

Stat 1 - perform steps 1-3 and 5.

Stat 2 -perform steps 1-2 and then press **PROG** and **CH2** on **RX2**.

**RX3 (if applicable)**

Stat 1 - perform steps 1-3 and 5.

Stat 2 - perform steps 1-2 and then press **PROG** and **CH2** on **RX3** then **step 5**.

Stat 3 - perform steps 1-2 and then press **PROG** and **CH3** on **RX3**.

**Step 5**

**TP5000Si-RF** - Press **V** or **Λ** to select temperature - the unit will revert back to operating mode.

# Installer advanced programming options

---

TP5000 Si incorporates a number of advanced features which can be set by the user. These are accessed via a User Advanced Programming Mode, please refer to **User Advanced Programming** in the user instructions for details (see page 25).

## Installer advanced programming options

---

TP5000 Si incorporates an additional number of advanced features which can be set by the installer to improve the operating efficiency of the system and where required, to change the user functionality of the product. These are accessed via an Installer Advanced Programming Mode. These settings are optional and need only be made if there is a demand for the enhanced functions.



# Service Interval Timer

Instructions on how to access this feature are available from our customer support desk. Please note these are only issued to boni-fide heating installers.

## Entering Installer Advanced Programming Mode

To access the Installer Advanced Programming Mode follow the steps below:

a) Press and hold **V** and **PROG** for 3 seconds to enter User Advanced Programming, the display will change to figure opposite.



b) Press and hold **V**, **Λ** and **PROG** for 5 seconds to enter Installer Advanced Programming, the display will change to figure opposite.



c) Use + and - keys to scroll backwards and forwards between options then **V** and **Λ** keys to change the option settings. The flashing digit on the right hand of the display indicates the number of the selected option. The large characters display the option value selected.

d) To return to **RUN**, press and hold **PROG** until the display returns to previous **RUN** mde.

Option 30 - Set upper limit of temperature range	
This allows the upper limit of the thermostat setting range to be electronically limited. Press + until Option 30 is displayed, use <b>V</b> and <b>Λ</b> to select required setting.	
<b>Setting</b>	40 - 5°C (Factory setting is 30°C)





Option 31 - Set lower limit of temperature range	
This allows the lower limit of the thermostat setting range to be electronically limited. Press + until Option 31 is displayed, use <b>V</b> and <b>Λ</b> to select required setting.	
<b>Setting</b>	5 - 40°C (Factory setting is 5°C)





<b>Option 32 - Enable Off at lower limit</b>	
This enables an <b>OFF</b> function to be selected if a set point below the lower limit is selected. Press + until Option 32 is displayed, use <b>V</b> and <b>Λ</b> to select required setting.	
	
<b>Setting 0</b>	Disabled
<b>Setting 1</b>	Enabled (factory setting)

<b>Option 33 - Enable On at upper limit</b>	
This enables an <b>ON</b> function to be selected if a set point above the upper limit is selected. Press + until Option 33 is displayed, use <b>V</b> and <b>Λ</b> to select required setting.	
	
<b>Setting 0</b>	Disabled (factory setting)
<b>Setting 1</b>	Enabled

<b>Option 34 - Select On/Off or Chrono-proportional</b>	
This allows the thermostat to be set to run in On/Off mode or for a chrono-proportional cycle rate to be selected. Press + until Option 34 is displayed, use <b>V</b> and <b>Λ</b> to select required setting.	
	
<b>0</b>	On/Off
<b>3</b>	3 cycles per hour
<b>6</b>	6 cycles per hour (factory setting)
<b>9</b>	9 cycles per hour
<b>12</b>	12 cycles per hour

<b>Option 35 - Set integration time (Option 34 set to 3, 6, 9 or 12) (seek advice prior to adjusting)</b>	
This adjusts the integration time of the PI algorithm to increase control accuracy. It is only active if option 34 has been set to Chrono 3, 6, 9 or 12. It should only be adjusted after seeking advice from the manufacturer. Press + until Option 35 is displayed, use <b>V</b> and <b>Λ</b> to select required setting.	
	
<b>2.5</b>	Integration time set to 2.5% (factory setting)
<b>5</b>	Integration time set to 5%
<b>10</b>	Integration time set to 10%

<b>Option 36 - Set temperature override rule</b>	
This establishes the degree of temperature override available to the user. Press + until Option 36 is displayed, use <b>V</b> and <b>Λ</b> to select required setting.	
	
<b>Setting 0</b>	No limit (factory setting)
<b>Setting 1</b>	Limited to $\pm 2^{\circ}\text{C}$
<b>Setting 2</b>	No override allowed

<b>Option 37 - Set time duration of override rule (Option 36 set to 1 or 2)</b>	
This establishes the duration of a temperature override available to the user. Press + until Option 37 is displayed, use <b>V</b> and <b>Λ</b> to select required setting.	
	
<b>Setting 0</b>	Next event (factory setting)
<b>Setting 1</b>	1 hour
<b>Setting 2</b>	2 hours
<b>Setting 3</b>	3 hours
<b>Setting 4</b>	4 hours

<b>Option 38 - Relay state on low battery detect (battery products only)</b>	
This establishes the position that the relay is driven to when the unit shuts down due to low battery state. Press + until Option 38 is displayed, use <b>V</b> and <b>Λ</b> to select required setting.	
	
<b>Setting 0</b>	Relay parked with output <b>OFF</b> (factory setting)
<b>Setting 1</b>	Relay parked with output <b>ON</b>

<b>Option 40 - Number of Events per Day</b>	
This sets the thermostat to operate with either 2, 4 or 6 switching events per day or to run it in stat mode. Press + until option 40 is displayed, use <b>Λ</b> or <b>V</b> to select required setting.	
	
<b>1</b>	Stat mode
<b>2</b>	Two switching events per day
<b>4</b>	Four switching events per day (Factory setting)
<b>6</b>	Six switching events per day



<b>Option 41 - Operating Mode (5/2 day or 24 hour)</b>	
This sets the thermostat to operate using either 5/2 day or 24 hour mode. Press + until option 41 is displayed, use <b>Λ</b> or <b>V</b> to select required setting.	
<b>5-2</b>	5/2 day (Factory setting)
<b>24</b>	24 hour

<b>Option 70 - Keyboard disable rules</b>	
This establishes the degree of functionality of the keyboard available to the user. It is only active if DIL switch 1 is set to "Disabled". Press + until Option 70 is displayed, use <b>V</b> and <b>Λ</b> to select required setting.	
<b>Setting 0</b>	Normal lock: Programming functions locked (factory setting)
<b>Setting 1</b>	Full lock: All keys are disabled

<b>Option 71 - Random start rules (24V/230 Volt models only)</b>	
This enables a random start on power-up following a power cut to reduce load on the electrical network. Random delay is in the range of 2 - 90 seconds. Press + until Option 71 is displayed, use <b>V</b> and <b>Λ</b> to select required setting.	
<b>Setting 0</b>	Disabled (factory setting)
<b>Setting 1</b>	Enabled

<b>Option 72 - Owner site reference number</b>	
This enables multi-site owners to store a site reference number in the thermostat. Press + until Option 72 is displayed, use <b>V</b> and <b>Λ</b> to select required setting.	
<b>Setting</b>	Any value between 00 and 99 can be set
Factory setting is 00	

<b>Option 73 - Owner thermostat reference number</b>	
This enables site owners to store a thermostat reference number in the thermostat. Press + until Option 73 is displayed, use <b>V</b> and <b>Λ</b> to select required setting.	
<b>Setting</b>	Any value between 000 and 999 can be set
Factory setting is 000	

**Option 74 - Date format for calendar clock**

This allows date format to be chosen. Press + until Option 74 is displayed, use **V** and **Λ** to select required setting.



**Setting 0** European format (dd/mm/yy), (Factory setting)

**Setting 1** North American format (mm/dd/yy)

**Option 81 - Thermostat calibration bias**

This allows the thermostat calibration to be biased by up to  $\pm 1.5^{\circ}\text{C}$ . Press + until Option 81 is displayed, use **V** and **Λ** to select required setting.



**Setting** Any value between  $\pm 1.5$  in  $0.5^{\circ}\text{C}$  steps (Factory setting is  $0^{\circ}\text{C}$ )

**Option 90 - Define remote sensor type, "A" models only**

This allows type of remote sensor input type to be defined. Press + until Option 90 is displayed, use **V** and **Λ** to select required setting.



**Setting 0** No remote sensor fitted (Factory setting)

**Setting 1** Remote room or duct sensor fitted, internal sensor disabled,

**Setting 2** Remote limit sensor fitted, refer to option 93 to define set-point

**Setting 3** Configured as digital input for window, card reader or teleswitch, refer to option 94 to define o/c or s/c.

**Option 93 - Set limit sensor set-point, "A" models only, (option 90 set to 2)**

This allows the thermostat limit sensor to be set, typical application is floor heating. Press + until Option 93 is displayed, use **V** and **Λ** to select required setting. If the temperature sensed by the limit sensor exceeds the limit setting the output will be turned off until the temperature has dropped by  $2^{\circ}\text{C}$ . "F10" will flash in the display while the output is disabled.



**Setting** Any value between 20 -  $50^{\circ}\text{C}$  (Factory setting is  $27^{\circ}\text{C}$ )



**Option 94 - Configure digital input switch type, "A" models only, (option 90 set to 3)**

This allows switch type of digital input to be configured. Press + until Option 94 is displayed, use **V** and **Λ** to select required setting.



<b>Setting 0</b>	Contacts NC, open circuit contact to force unit into thermostat mode, short circuit contacts to return to normal operation
<b>Setting 1</b>	Contacts NO, short circuit contacts to force unit into thermostat mode, open circuit contacts to return to normal operation (Factory setting)

# TACMA

THE ASSOCIATION  
OF CONTROLS  
MANUFACTURERS

11385

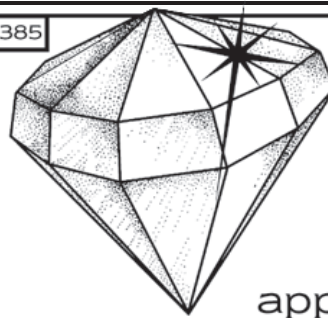

## Crystal Mark

Clarity  
approved by  
Plain English Campaign

GB

User Instructions

### What is a programmable room thermostat?

... an explanation for householders

A programmable room thermostat is both a programmer and a room thermostat. A programmer allows you to set 'On' and 'Off' time periods to suit your own lifestyle. A room thermostat works by sensing the air temperature, switching on the heating when the air temperature falls below the thermostat setting, and switching it off once this set temperature has been reached.

So, a programmable room thermostat lets you choose what times you want the heating to be on, and what temperature it should reach while it is on. It will allow you to select different temperatures in your home at different times of the day (and days of the week) to meet your particular needs.

Turning a programmable room thermostat to a higher setting will not make the room heat up any faster. How quickly the room heats up depends on the design of the heating system, for example, the size of boiler and radiators.

Neither does the setting affect how quickly the room cools down. Turning a programmable room thermostat to a lower setting will result in the room being controlled at a lower temperature, and saves energy.

The way to set and use your programmable room thermostat is to find the lowest temperature settings that you are comfortable with at the different times you have chosen, and then leave it alone to do its job. The best way to do this is to set low temperatures first, say 18°C, and then turn them up by one degree each day until you are comfortable with the temperatures. You won't have to adjust the thermostat further. Any adjustments above these settings will waste energy and cost you more money.

If your heating system is a boiler with radiators, there will usually be only one programmable room thermostat to control the whole house. But you can have different temperatures in individual rooms by installing thermostatic radiator valves (TRVs) on individual radiators. If you don't have TRVs, you should choose a temperature that is reasonable for the whole house. If you do have TRVs, you can choose a slightly higher setting to make sure that even the coldest room is comfortable, then prevent any overheating in other rooms by adjusting the TRVs.

The time on the programmer must be correct. Some types have to be adjusted in spring and autumn at the changes between Greenwich Mean Time and British Summer Time. You may be able to temporarily adjust the heating programme, for example, 'Override', 'Advance' or 'Boost'. These are explained in the manufacturer's instructions.

Programmable room thermostats need a free flow of air to sense the temperature, so they must not be covered by curtains or blocked by furniture. Nearby electric fires, televisions, wall or table lamps may prevent the thermostat from working properly.



# User Instructions

## An introduction to your programmable room thermostat

---

Your programmable room thermostat allows you to programme different temperatures at different time periods. You can programme one set of times and temperatures for week days with a different set of temperatures for weekend days, this is referred to as 5/2 day operation.

The thermostat can also be set up by your installer to provide one set of times and temperatures that are repeated each day of the week. This is referred to as 24 hour operation.

The thermostat can also be set by you to provide two different programming blocks which can then be assigned to any day of the week, this is referred to as A/B programme operation.

All thermostats can be set by your installer to provide up to 2, 4 or 6 time and temperature settings each day.

All thermostats feature useful overrides, including a programmable frost setting.

Your thermostat has some advanced features which the installer will set-up if they are required. There are also a number of advanced features which can be set up by you. These advanced settings alter the way that your thermostat operates, some also affect the programming functions and the user overrides. Please read the **User Advanced Programming** instructions before programming the unit (see page 25).

## Preset programmes

---

Your TP5000 Si comes ready programmed with a set of operating times and temperatures which suit most people. Please remember that some of the options available will depend on how the installer has set up the unit.



<b>Weekdays (Mon-Fri)</b>		
<b>Event</b>	<b>Time</b>	<b>Temp. °C</b>
1	06:30	20
2	08:30	15
3	11:30	20
4	13:30	15
5	16:30	21
6	22:30	15
Note: these are also times for Block "A" programmes		

<b>Weekend (Sat-Sun)</b>		
<b>Event</b>	<b>Time</b>	<b>Temp. °C</b>
1	07:30	20
2	09:30	20
3	11:30	20
4	13:30	20
5	16:30	21
6	22:30	15
Note: these are also times for Block "B" programmes		

Note: If set up for 4 events per day, events 3 & 4 are skipped. If set up for 2 events per day, events 2, 3, 4 & 5 are skipped. In both cases the events are re-numbered.

## Before you start

Open the flap on the front of the programmer and press the **RESET** button with a non-metallic object until the display goes blank. This will ensure that the micro-computer in the product is operating correctly.

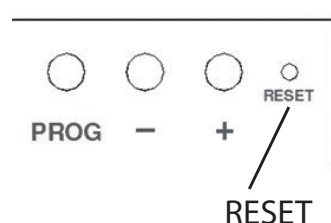

## Customising the display

For the sake of clarity, the instructions assume that the display setting uses a 24 hour clock, °C and that days of the week are shown as text. All of these settings can be personalised after the thermostat has been programmed, see pages 22 - 24.

## Setting the correct date and time

Your TP5000 Si incorporates a real time clock with calendar function that automatically changes time in both Spring and Autumn. The time and date is set in the factory for the UK time zone, and does not normally require adjustment. If you live in another time zone refer to "Time zone offset" on page 26. However, should it be found necessary to adjust time or date for any other reason refer to the following instructions.

## Setting the date

Press and hold **Λ** and **PROG** for 3 seconds, to display date in dd/mm/yy format.

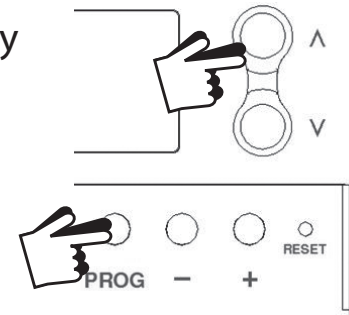

The **YEAR** number will flash, use **Λ** or **V** to correct the year.

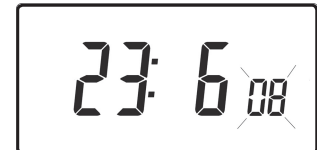

Use - or + to move to **MONTH**, then use **Λ** or **V** to correct month.



Use - or + to move to **DATE** in month, then use **Λ** or **V** to correct day in month.

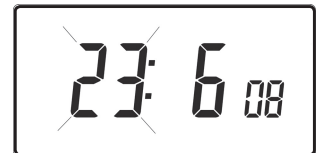

If you attempt to select an invalid date the unit software will reject it and apply the nearest valid date. It is recommended that date is set in the order, yy/mm/dd.

## Setting the correct time

After setting the date press **PROG** to display the time. The time display will flash on and off.

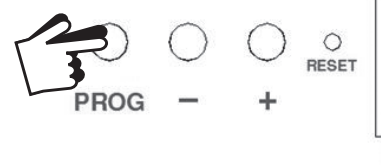

Use the + and - buttons to set the correct time (press and hold to change in 10 min. increments).



## Setting the correct day

The day of the week is set automatically. Press **PROG** to return to normal operation (**RUN**).



## Accepting the preset programmes

---

If you are happy with the preset times shown in the table on page 17 you need take no further action.

## Changing the preset programmes

---

### *Before you change the preset programmes*

Your installer will have set the unit to operate in one of the following modes:

- 5/2 day - one set of programmes for weekdays and another for weekends (page 19-20).
- 24 hr - one set of programmes for the whole of the week (page 20).

### *Alternatively*

- A/B - The unit can also be set by you to provide two programme blocks, either of which can be applied to different days of the week. If this is required refer to page 21 for instructions on how to turn on this feature.

### **Please Note**

The unit must be programmed in sequence, event times cannot be set out of sequence.

If you want to leave a preset time as it is, simply press **PROG** to move to the next setting.

If you want to return the unit to **RUN**, press **PROG** and hold until the display returns to the previous **RUN** mode. Alternatively leave alone and the unit will automatically return to **RUN** after 2 minutes.

Your installer will have set your unit to programme 6, 4 or 2 events per day. This will determine the number of events per day that you are able to programme.

## Changing the preset programmes in 5/2 day mode

---

### *For Weekdays*

- Press **PROG** until the first preset time and temperature (Event 1 Days MON, TUE, WED, THU, FRI) appears in display.





- b) Use the + and - buttons to adjust the **TIME** (press and hold to change in 10 minute increments).
- c) Use the **Λ** and **V** buttons to adjust the required **TEMPERATURE**.
- d) Press **PROG** to move to the next preset time and temperature (Event 2).
- e) Repeat steps b, c, & d to programme the remaining weekday events.



**For Weekends**

Press **PROG** until the first preset time and temperature (Event 1 Days SAT, SUN) appears in display.



Repeat steps b, c, & d above to programme the remaining weekend events.

**Changing the preset programmes in 24 hour mode**

- a) Press **PROG** until the first preset time and temperature (Event 1 for all days of the week) appears in display.

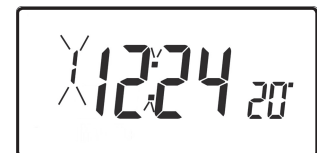

- b) Use the + and - buttons to adjust the **TIME** (press and hold to change in 10 min increments).
- c) Use the **Λ** and **V** buttons to adjust the required **TEMPERATURE**.

- d) Press **PROG** to move to the next preset time and temperature (Event 2).



- e) Repeat steps b, c, & d to programme the remaining events.

# Changing preset programmes for AB programming

*(Installer setting must be in 5/2 day mode)*



Press and hold **PROG** and **V** for 3 seconds. The display will change to the figure opposite. This will take you into **User Advanced Programming** option 1.



Use **Λ** and **V** keys to enable or disable the function (1=enabled, 0=disabled).



Press **PROG** for 5 seconds until the display returns to previous **RUN** mode.

Press **PROG** once, the display will change to show the default days assigned to programme "A" (days MON, TUE, WED, THU, FRI).

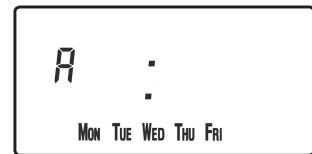

Use the + and - keys to scroll forwards or backwards through the days of the week.

To deselect a day press **V**, (for example TUE). To select a day press **Λ** (for example SUN).

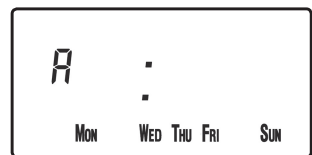

Any deselected days are automatically assigned to programme "B".

## Programming "A" programme days and events

a) Press **PROG** until the first preset time and temperature (Event 1 for Programme A) appears in display.



b) Use the + and - buttons to adjust the **TIME** (press and hold to change in 10 minute increments).

c) Use the **Λ** and **V** buttons to adjust the required **TEMPERATURE**.

d) Press **PROG** to move to the next preset time and temperature (Event 2).

e) Repeat steps b, c, & d to programme the remaining events.

## Programming "B" programme days and events

- Press **PROG** until the first preset time and temperature (Event 1 for Programme B) appears in the display.
- Use the + and - buttons to adjust the **TIME** (press and hold to change in 10 minute increments).
- Use the **Λ** and **V** buttons to adjust the required **TEMPERATURE**.
- Press **PROG** to move to the next preset time and temperature (Event 2).
- Repeat steps b, c, & d to programme the remaining events.



## Running the programme

Press **PROG** to return to previous **RUN** mode. The heating will now follow the times and temperatures programmed.



# User Overrides

## Altering the display to show time or temperature

Press + and - together to change between settings.

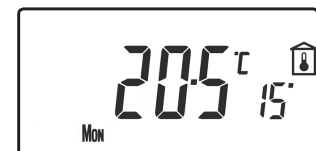

## Temporarily alter current programmed temperature

Press **Λ** or **V** until required temperature is displayed. Please note that your installer may have restricted both upper and lower temperature settings and the temperature override limits.

This override will automatically be cancelled at the beginning of the next programmed event. Please note that your installer may have restricted the duration of the override to something other than next event. In this case the override arrow will flash to indicate a timed override is active during the next event

## To change day of week legends from numbers to text

---

Press **Λ** and - together to toggle between day numbers and text.

## To change time display between 12 hour and 24 hour clock

---

Press **Λ** and + together to toggle between 12 and 24 hour clock.

## To change between °C and °F scaling

---

Press **V** and - together to toggle between °C and °F temperature scaling.

## Thermostat mode

---

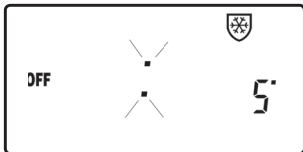
- A constant temperature of between 5-30°C can be selected if required. This can provide frost protection for periods away from home, it can also be used to provide untimed higher temperatures if, for example, a family member is sick.
- Press **Λ** and **V** together to enter thermostat mode. The default setting is 5°C, but this can be reprogrammed, see **User Advanced Programming**, step 10, (page 27).
- A frost protection symbol (snowflake in a shield) will appear in the display when the selected temperature is equal to or less than the programmed frost protection setting.  

- Use the **Λ** or **V** buttons to change the temperature away from the programmed frost protection temperature to another value.
- To return to automatic programming press both **Λ** and **V** together.



## Changing the clock forwards and backwards

---

This is handled automatically, however, if the manual changeover has been selected (User Advanced Programming step 3 on page 26) follow the instructions below.

### ***To change from Summer to Winter (clocks back)***

With clock display showing, press and hold - button until time moves back.

### ***To change from Winter to summer (clocks forward)***

With clock display showing, press and hold + button until time moves forward.

## Remote override into and out of thermostat mode

---

Selected models are available with a feature which allows a telephone activated switch or window contacts to step the unit into or out of thermostat mode.

The required temperature to be maintained when the building is unoccupied, or when windows are open, must first be set up in **User Advanced Programming**, step 10, (page 27).

To locally override this feature press both **Λ** and **V** together.

## Delay start feature

---

Your thermostat includes an optional delay start feature to hold off the heating for a time on mild days when the room temperature at the start of an event is close to the programmed value. If you have enabled this function it can be overridden by pressing either **Λ** or **V** buttons. To enable this feature, please refer to **User Advanced Programming**, step 11, (page 27).

When this function is active, the set temperature will flash on the display and an hourglass symbol will be displayed.



## Optimum start control (OSC)

---

Your thermostat includes an optional optimum start control. This feature allows you to set the time at which you require a room temperature by. The thermostat then calculates how soon before the event time the system must be turned up to ensure that the room is at the temperature by the required time. A full description of this and how to enable it and set it up is given in **User Advanced Programming**, steps 12 & 13, (page 28). When this function is active, the set temperature will flash on the display

## Battery replacement (battery models only)

---

When batteries are low a battery symbol will appear on the display. You have 15 days to replace the batteries before the unit shuts down. **When replacing batteries ensure that only high quality alkaline cells are use.**



**IMPORTANT:** *After replacing the batteries press and release the RESET button to restart the unit. All date, time, programming and override settings are maintained for the life of the product.*

# User Advanced Programming Options

---

**Important:** The thermostat has been set in the factory to suit most situations, however, there are additional optional settings which can improve the comfort, convenience and energy effectiveness of your thermostat. These are set in the **User Advanced Programming** and **Installer Advanced Programming** modes.

## To access User Advanced Programming

Press and hold **V** and **PROG** for 3 seconds. This will take you into **User Advanced Programming**. Use + and - keys to scroll backwards and forwards between options then **Λ** and **V** keys to change option settings. The flashing digit on the right hand of the display indicates the number of the selected option.

<b>Option 1 - Enable or disable A/B programming (option 41 set to 5+2)</b>	
This enables or disables the A/B programming option. Press + until Option 1 is displayed, use <b>Λ</b> and <b>V</b> to select required setting.	
	
<b>Setting 0</b>	Disabled, unit operates as 5+2 or 24 hour product depending on installer settings (factory setting)
<b>Setting 1</b>	Enabled: activates A/B programming

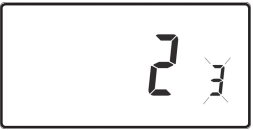
<b>Option 3 - Calendar clock rules</b>	
This establishes the rules that the automatic calendar clock follows to calculate changes between summer and winter time. Press + until Option 3 is displayed, use <b>Λ</b> and <b>V</b> to select required setting	
	
<b>Setting 0</b>	Disabled.
<b>Setting 1</b>	Manual: user must change using + to advance and - to retard displayed time.
<b>Setting 2</b>	European rules. (Factory Setting)
<b>Setting 3</b>	USA rules (2007 onwards)
<b>Setting 4</b>	USA rules (pre-2007)

<b>Option 4 - Time zone offset</b>	
This feature allows the time zone to be established and corrects time display. Press + until Option 4 is displayed, use <b>Λ</b> and <b>V</b> to select required setting	
	
<b>Setting 0</b>	UK models: this feature should be left at the factory setting of 0.
<b>Setting 1</b>	Central European time models: this feature should be left at the factory setting of +1:00.
<b>-12 Hours +14 Hours</b>	
Rest of World: use <b>Λ</b> and <b>V</b> keys to select offset from Universal time (GMT) for the location in which the thermostat is being installed.	

**Option 10 - Frost/ thermostat mode setting**

This feature allows the default frost/thermostat mode temperature to be set. Press + until Option 10 is displayed, use **Λ** and **V** to select required setting.



**5-40°C** - Factory setting is 5°C, but can be changed to any value between 5-40°C.

**Option 11 - Start-up method**

Your thermostat can start up the system in three different ways. Press + until Option 11 is displayed, use **Λ** and **V** to select required setting.



**Setting 0** Normal: Heating is turned up or down at the programmed times.

**Setting 1** Optimum start control (OSC) (or Comfort Setting): This allows you to programme the time at which you would like to be up to the required temperature. The thermostat then calculates how soon before the required time the heating is turned up. This will vary with weather conditions ranging from a maximum of 120 minutes to 0 minutes before the programmed event time. This setting must be used together with option 12 to match the optimiser setting to the building in which it is installed.

**Setting 2** Delay start (or Economy Setting): This is an alternative to OSC. Set the event times in the normal way taking into account the time that the building takes to heat on an average day. The thermostat monitors switch on time, actual temperature and wanted temperature and delays the start of the heating if the actual temperature is close to the programmed temperature.

**Option 12 - Optimum start control pre-heat setting  
(Option 11 set to 1)**

Press + until Option 12 is displayed, use **Λ** and **V** to select required setting (only active if Option 11 is set to 1).



The optimum start control must be adjusted to match the building energy characteristics. Use the **Λ** and **V** keys to selected the required pre-heat period. The table below suggests typical settings.

If the building fails to reach temperature on time, increase the setting by 15 minute steps each day until the correct setting is found.

If the building reaches temperature ahead of time, decrease the setting by 15 minute steps each day until the correct setting is found.

<b>0:15</b>	15 mins, warm air systems, well insulated building.
<b>0:30</b>	30 mins, warm air systems, well insulated building.
<b>0:45</b>	45 mins, warm air system poorly insulated building.
<b>1:00</b>	60 mins, radiator system, light weight well insulated building. (Factory setting)
<b>1:15</b>	75 mins, radiator system, light weight medium insulation.
<b>1:30</b>	90 mins, radiator system, medium weight poorly insulation.
<b>1:45</b>	105 mins, radiator system, heavy weight building, well insulated.
<b>2:00</b>	120 mins, radiator system, heavy weight building, poorly insulated.

**Option 13 - Optimum start control/Delayed start event setting  
(Option 11 set to 1 or 2)**

The Optimum start or delayed start control can be applied to event 1 only or to each event of the day which requires a higher temperature than the previous event. Press + until Option 13 is displayed, use **Λ** and **V** to select required setting (only active if Option 11 is set to 1 or 2).



<b>Setting 0</b>	Applies only to first event of day. (Factory setting)
<b>Setting 1</b>	Applies to each event of the day that requires a higher temperature compared to previous event.

# Overview of installer selectable features which may affect the operation of your thermostat

## Temperature range limitation

---

This allows the installer to programme both upper and lower temperature limits. It may limit the upper and lower temperature that you are able to set on the thermostat.

## Temperature override limitation

---

This allows the installer to limit the number of degrees that you can override the programmed temperature by, it also allows the installer to set rules regarding how long a temperature override will remain in place.

## Keyboard lock

---

This allows the installer to limit or lock the keyboard to prevent unauthorised changes to programme values and limits overrides.

## What happens to the unit when batteries fail

---

If batteries are not changed within 15 days of a low battery warning, the unit shuts down. In normal circumstances the thermostat turns off the valve or the boiler it is controlling. In extreme climates turning off the heating is likely to result in the building freezing up. To prevent this, the installer can set up the unit to turn the heating **ON** rather than turn **OFF** on battery failure. This will consume more fuel but will prevent damage occurring to the building. If appropriate please check that the installer has set this function correctly.

***Please note: If you replace the batteries and the LCD does not come on immediately please check battery orientation. Do not leave batteries in the product if the display is not active.***

***If, after changing the batteries, the screen remains blank it is necessary to carry out a partial reset. See page 30 for details.***

## Service Interval Timer

---

- If the property is owned by a landlord he may, for gas safety reasons, have instructed the installer to set the service interval timer.
- If set, 28 days prior to the service due date, a visual and audible warning will start each day at noon. The audible warning will last for 10 seconds and will be repeated every hour until a button is pressed to cancel it. If cancelled the alarm will recommence the following day at noon.
- If the boiler is not serviced before the due date, a visual and audible warning will start each day at noon. The audible warning will last for 1 minute and will be repeated every hour until a button is pressed to cancel it. If cancelled the alarm will recommence the following day at noon.
- In addition, all overrides and programming buttons will be disabled and the heating may operate for a limited amount of time each hour.
- The installer may cancel or reset the service interval timer as part of the boiler service.
- This is a gas safety feature that can only be accessed by an installer.

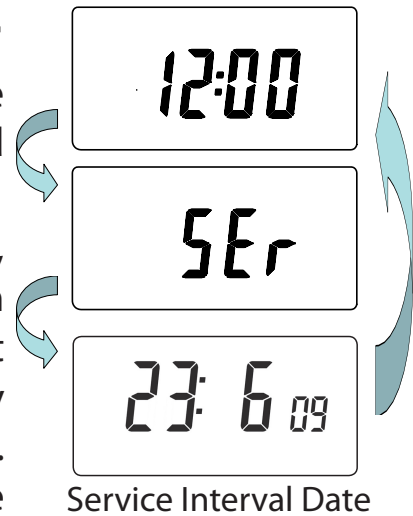

## Resetting the unit

---

**Partial reset:** Press **RESET** (used to restart micro-computer) if display freezes for any reason. This does not reset any programme, clock or date. It is recommended that this is done at time of installation.

**User full reset:** Press **RESET** whilst holding down **PROG** button. This resets event times and any User Advanced Programme setting, but does not reset time or date.

**Installer full reset:** This is only available to the installer. In addition to the above all of the Installer Advanced Programming settings are returned to factory settings, however, time, date and service due date are not reset.

# Settings Reference



*Note to installers:*

*Please use this table to record changes to default settings.*

<b>Installer Settings</b>		
<b>Option</b>	<b>Description</b>	<b>Installer Set Value</b>
30	Set upper limit of temperature range	
31	Set lower limit of temperature range	
32	Enable Off at lower limit	
33	Enable On at upper limit	
34	Select On/Off or Chrono-proportional	
35	Set Integration Time	
36	Set temperature override rule	
37	Set time duration of override rule	
38	Relay state on low battery detect (battery products only)	
40	Number of events per day	
41	Operating mode (5/2 day or 24 hour)	
70	Keyboard disable rules	
71	Random start rules (24V/230V only)	
72	Owner site reference number	
73	Owner thermostat reference number	
74	Date format for calendar clock	
81	Thermostat calibration bias	
90	Define remote sensor type ("A" models only)	
93	Set limit sensor set-point ("A" models only)	
94	Configure digital input switch ("A" models only)	

<b>User Settings</b>		
<b>Option</b>	<b>Description</b>	<b>Installer Set Value</b>
1	Enable or disable A/B programming	
3	Calendar Clock Rules	
4	Time zone offset	
10	Frost/Thermostat mode setting	
11	Start-up method	
12	Optimum start control pre-heat setting	
13	Optimum start control/Delayed start event setting	

## Still having problems?

*Call your local heating engineer:*

Name: .....

Tel: .....

## For problems relating to your heating controls ...

*Visit our website:*

**[www.danfoss-randall.co.uk](http://www.danfoss-randall.co.uk)**

*Email our technical department:*

**[drl\\_technical@danfoss.com](mailto:drl_technical@danfoss.com)**

*Call our technical department*

**0845 121 7505**

*(8.45-5.15 Mon-Thurs, 8.45-4.45 Fri)*

**For a large print version of these instructions  
please contact the Marketing Services  
Department on 0845 121 7400.**

---



**Danfoss Randall Ltd**

Amphill Road

Bedford

MK42 9ER

Tel: 01234 364621

Fax: 01234 219705

