

Module 4 Profile 400, 800 and Slenderline Rail Kit Fitting Instructions

Standard Pack Contents

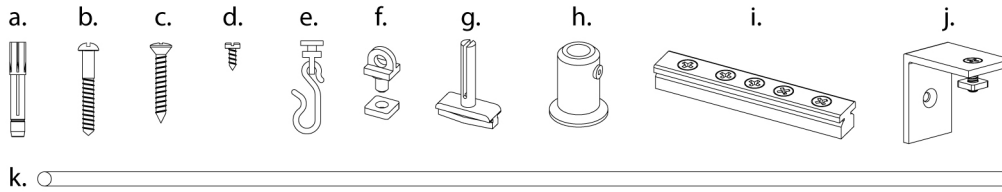

Mod 400 Specific Pack Contents

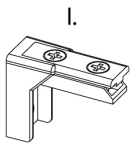

Mod 800 Specific Pack Contents

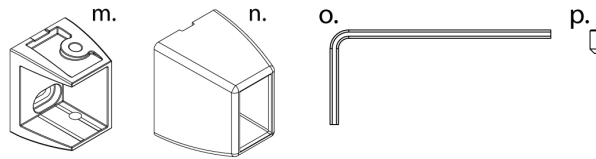

Standard fitting packs are included with this product, therefore you may find that some components are not required for the rail that you have purchased.

- | | |
|--|---|
| (a) Wall plugs x 4-10* | (k) Hanger rod x 1 or 2** |
| (b) No. 8 x 1 ¼" screws x 4 -10* | (l) Mod 400 wall bracket and track insert x 2**** |
| (c) No. 6 x 1" self tapping screw x 1 or 2* | (m) Mod 800 wall bracket x 2**** |
| (d) No. 4 x ¼" self tapping screw x 1 or 2* | (n) Mod 800 decorative cover x 2**** |
| (e) Gliders and hooks x 12 - 24* | (o) Hex Key x 1 |
| (f) End stop and fixing nut x 1 or 2* | (p) Grub Screw x 2 |
| (g) Ceiling hanger support x 1 or 2** | (q) Slenderline Long Rail x 1 (Diagram not shown) ***** |
| (h) Ceiling support bracket x 1 or 2** | (r) Slenderline Short Rail x 2 (Diagram not shown) ***** |
| (i) Connector x 1 or 3*** | (s) Slenderline Corner Rail x 2 (Diagram not shown) ***** |
| (j) L shape bracket, nuts and mounting screws x 3*** | (t) Dust Cover (Diagram not shown) |

* The actual quantity supplied will vary according to the product.

** These items are not supplied with the straight rail.

*** 1 x Connector and L shape brackets, nuts and mounting screws are supplied with the rectangular rail ONLY.

**** 3 x Connectors are supplied with Slenderline.

***** This item is not supplied with the rectangular rail.

***** This item is only supplied with the slenderline shower rail kit.

Tools Required

Drill, 5.5mm masonry drill bit, 5.5mm ceramic drill bit (optional), Flat head and cross head screwdriver, Pencil, Spirit level, Tape measure, Small hacksaw (optional), Sharp Knife.

KEEP DIY TOOLS OUT OF THE REACH OF CHILDREN

Safety and Care Advice

- 1) Always take care when using an electric drill, particularly in the bathroom. Always check for hidden cables and pipework before drilling and take extreme care if there is any water in the working area.
- 2) It is advisable to use a residual current circuit breaker (RCCB). Always wear suitable eye protection when drilling.
- 3) If the product is to be fitted on to a ceramic tiled wall, a ceramic drill bit should be used. Always ensure that the drill hole passes through the central tiled area rather than through the grouted area. To prevent damage to the tile, mask the area around the hole with tape before drilling.
- 4) It is recommended that two people fit the rail to ensure that it is fitted safely.
- 5) Do not overload the rail. Use a maximum of two standard shower curtains.
- 6) Clean with a damp cloth.
- 7) Do not use abrasive or chemical cleaners.
- 8) Do not use this product as a grab bar.
- 9) If you find your gliders become sticky in use then spray a small amount of furniture polish into the bottom channel of the track to improve glider performance.

Mod 400 Fitting Instructions – All rails EXCEPT Rectangular

- 1) Remove the pre-assembled dust cover from the top of the rail to allow for the positioning of the ceiling support rod during installation.
- 2) Slide the gliders and hooks onto the bottom half of the rail – see Fig. 1. Position the end stop at the end of the rail and slide the wall brackets onto both ends of the rail – see Fig. 2.
- 3) Place the rail in the desired location allowing for adequate curtain overlap into the bath or shower tray, then make a mark on the wall at the top of each wall bracket
- 4) Remove the wall brackets from the rail and place them in the locations previously marked on the wall. Mark the mounting screw holes onto the wall through the corresponding mounting screw holes in the wall brackets. Ensure that the bracket hole centres are level to each other.
- 5) Drill the holes in the marked positions using a 5.5mm masonry drill. If the product is to be fitted onto a ceramic tiled wall a ceramic drill bit should be used.
- 6) Insert the wall plugs flush to the surface of the wall. If fitting to a tiled surface, the wall plug should be inserted below the surface of the tile. Secure the wall brackets in position using the No. 8 x 1 ¼" screws provided.
- 7) Insert the ceiling hanger support moulding into the hanger rod and secure in place using the No. 6 x 1" self-tapping screw. Slide the ceiling hanger assembly (see Fig.5) into the top channel of the rail. It may be necessary to shorten the hanger rod with a hacksaw to ensure that the rail is level.
- 8) The assembled rail can then be pushed into the wall brackets and secured into position by tightening the two screws on the top of the wall brackets.

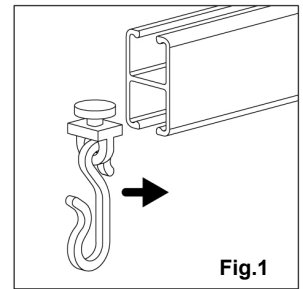

Fig.1

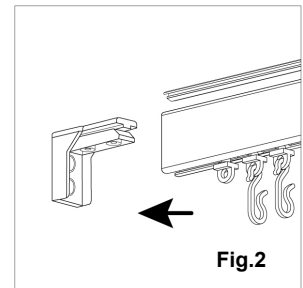

Fig.2

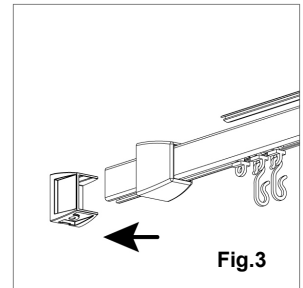

Fig.3

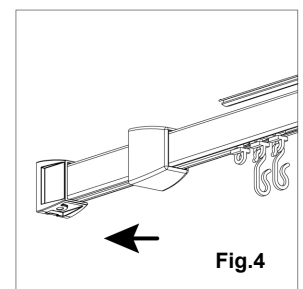

Fig.4

Mod 800 Fitting Instructions – All rails EXCEPT Rectangular

- 1) Remove the pre-assembled dust cover from the top of the rail to allow for the positioning of the ceiling support rod during installation.
- 2) Slide the gliders, hooks and the end stop onto the bottom half of the rail – see Fig. 1. Slide the wall brackets onto both ends of the rail – see Fig. 3. Ensure the open sides of the wall brackets are facing into the bath or shower tray.
- 3) Place the rail in the desired location allowing for adequate curtain overlap into the bath or shower tray, then make a mark on the wall at the top of each wall bracket
- 4) Remove the wall brackets from the rail and place them in the locations previously marked on the wall. Mark the mounting screw holes onto the wall through the corresponding mounting screw holes in the wall brackets. Ensure that the bracket hole centres are level to each other.
- 5) Drill the holes in the marked positions using a 5.5mm masonry drill. If the product is to be fitted onto a ceramic tiled wall a ceramic drill bit should be used.
- 6) Insert the wall plugs flush to the surface of the wall. If fitting to a tiled surface, the wall plug should be inserted below the surface of the tile. Secure the wall brackets in position using the No. 8 x 1 ¼" screws provided.
- 7) Insert the ceiling hanger support moulding into the hanger rod and secure in place using the No. 6 x 1" self-tapping screw. Slide the ceiling hanger assembly (see Fig. 5) into the top channel of the rail. It may be necessary to shorten the hanger rod with a hacksaw to ensure that the rail is level. Place the decorative covers onto the rail ends.
- 8) The assembled rail can then be pushed into the wall brackets and secured into position by tightening the screw on the top of the wall brackets. **DO NOT OVERTIGHTEN.** Slide the decorative covers over each wall bracket to complete the installation of the rail – See Fig.4

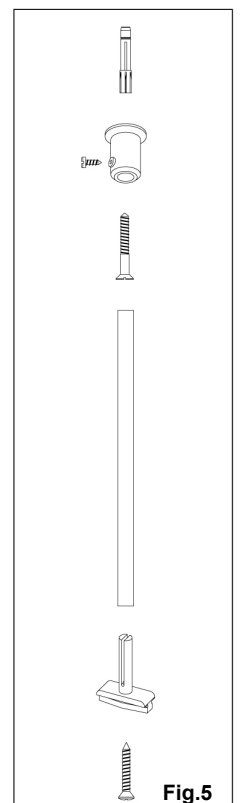
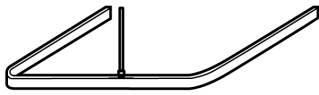

Fig.5

Slenderline Shower Rail Kit Instruction Leaflet

Slenderline Rail Configurations and Suggested Rail Layouts



U-shape.
Join together two short rails and two corner rails.
91cm x 68.5cm x 91cm
(36" x 27" x 36") approx



Large L-shape
Join together two short rails, one long rail and one corner rail
167.5cm x 91cm
(66" x 36") approx

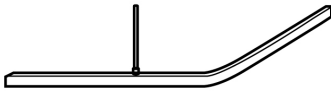

L-shape
Join together two short rails and one corner rail
91cm x 91cm
(36" x 36") approx

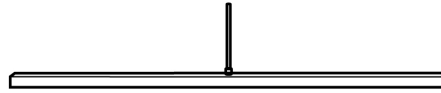

Straight
Join together two short rails and one long rail.
190.5cm
(75") approx

Prior to fitting your Slenderline Shower Rail Kit please double check the supplied component packs.

- 1) Lightly assemble the rail – see Fig.6. The rail sections should be joined together using the connectors – see Fig.7. Slide the gliders and hooks on to the bottom half of the rail - see Fig.1. Position the end stop at the end of the rail and slide the wall brackets and decorative covers on to both ends of the rail – see Fig.2 and Fig.3 for both Module 4 Profile 400 and 800 assemblies.
- 2) Place the rail in the desired location allowing for adequate curtain overlap into the bath or shower tray, then make a mark on the wall at the top of each wall bracket
- 3) Remove the wall brackets from the rail and place them in the locations previously marked on the wall. Mark the mounting screw holes onto the wall through the corresponding mounting screw holes in the wall brackets. Ensure that the bracket hole centres are level to each other.
- 4) Drill the holes in the marked positions using a 5.5mm masonry drill. If the product is to be fitted onto a ceramic tiled wall, a ceramic drill bit should be used.
- 5) Insert the wall plugs flush to the surface of the wall. If fitting to a tiled surface, the wall plug should be inserted below the surface of the tile. Secure the wall brackets in position using the No.8 x 1 ¼" screws provided.
- 6) Insert the ceiling hanger support moulding into the end of the hanger rod and secure in place using the No. 6 x 1" self tapping screw (see Fig. 5). Slide the ceiling hanger assembly into the top channel of the rail. It may be necessary to shorten the hanger rod with a hacksaw to ensure that the rail is level.
- 7) The assembled rail can then be pushed into the wall brackets and secured into position by tightening the screw(s) on the top of the wall brackets.
- 8) If fitting a Module 4 Profile 800 Slenderline Kit, slide the decorative covers over each wall bracket to complete the assembly – See Fig.4.

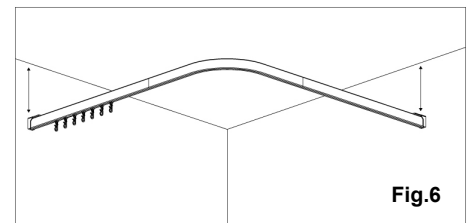

Fig.6

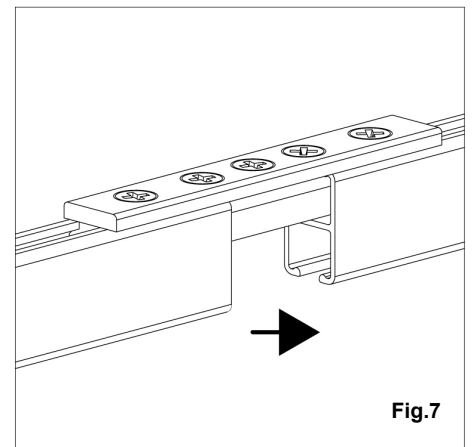

Fig.7

Fitting the Ceiling Hanger

- 1) Find a suitable location for the position of the ceiling support bracket such as a joist closest to the corner of the rail. If a suitable joist cannot be located, use a cavity wall plug for extra strength. (Not provided).
- 2) When you have identified a suitable fixing location the hanger rod can be used as a guide to mark the exact centre of the ceiling support bracket. Ensure the rod is vertical in all directions before drilling into the ceiling.
- 3) If using a wall plug, drill a hole using a 5.5mm drill bit and insert the wall plug. Fit the No. 8 x 1 ¼" screw into the ceiling support bracket and screw into the wall plug or joist. See Fig. 5.
- 4) Position the hanger rod into the ceiling support bracket and secure into position using the No. 4 x ¼" self tapping screw.

Fitting the Dust Cover

Cut the dust cover into the required lengths with a sharp knife and insert into the top channel of the rail.

Straight Rail Mod 400

Where a straight rail is fixed wall-to-wall the track insert should be unscrewed from the wall bracket and positioned in the top channel of the rail. The rail should then be offered up to the wall bracket from underneath and the screws re-inserted and tightened. If necessary, the rail can be cut with a small hacksaw.

Fitting Instructions – Rectangular Rail ONLY

- 1) Remove the pre-assembled dust cover from the top of the rail to allow for the positioning of the ceiling support rod during installation.
- 2) Loosely assemble the wall brackets and securing screws into the top channel of the rail using the dimensions in Fig.8
- 3) Place the rail in the desired location allowing for adequate curtain overlap into the bath or shower tray, then make a mark on the wall to indicate the top of each wall bracket.
- 4) Remove the wall brackets from the rail and place them in the locations previously marked on the wall. Mark the mounting screw holes onto the wall through the corresponding mounting screw holes in the wall brackets. Ensure that the bracket hole centres are level to each other and double check that they have been placed in the correct positions according to the dimensions given in Fig.8.
- 5) Drill the holes in the marked positions using a 5.5mm masonry drill. If the product is to be fitted onto a ceramic tiled wall a ceramic drill bit should be used.
- 6) Insert the wall plugs flush to the surface of the wall. If fitting to a tiled surface, the wall plug should be inserted below the surface of the tile. Secure the wall brackets in position using the No. 8 x 1 ¼" screws provided.
- 7) Insert the ceiling hanger support into the hanger rod and secure in place using the No. 6 x 1" self-tapping screw. Slide the ceiling hanger assembly (see Fig.5) into the top channel of the rail until it reaches position D as shown in Fig.8. It may be necessary to shorten the hanger rod with a hacksaw to ensure that the rail is level.
- 8) Loosely assemble the mounting screw and nut in brackets A and C as shown in Figs 9 and 10. Slide one of the open ends of the rail onto bracket C rotating the rail as it slides along the bracket – as shown in Fig.10. Continue so that the open ends of the rail are level with bracket A and then slide the opposite end of the rail onto the mounting screw in bracket A and reverse the rotation until the rail is parallel to the wall – see Fig.8.
- 9) Slide the gliders and hooks onto the bottom half of the rail – see Fig. 1. Position the end stop where required.
- 10) Slide the securing nut for bracket screw B into the top channel of the rail and slide it into position under bracket B - see Fig.11.
- 11) Insert the straight connector into the ends of the rail – as shown in Fig.12 and secure tightly into position.
- 12) Secure the rail into wall brackets A and C by tightening the screws and insert the mounting screw into bracket B and screw into the nut which is already in position in the top channel.

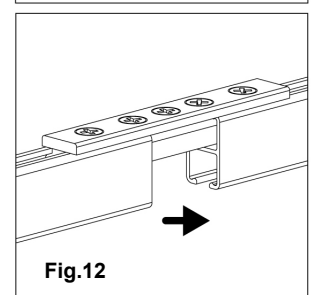
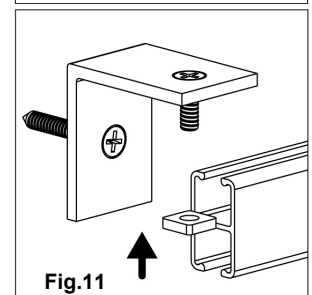
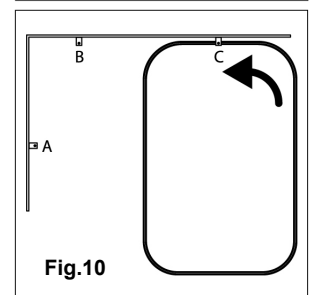
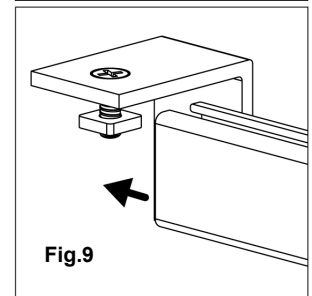
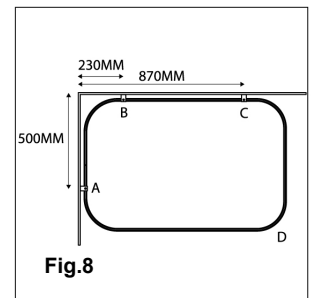

PLEASE KEEP THESE INSTRUCTIONS FOR FUTURE REFERENCE.

Croydex Ltd, Central Way, Andover, Hants, SP10 5AW, UK.
Tel: +44 (0)1264 365881 ~ Fax: +44 (0)1264 356437
Website: www.croydex.com ~ E-Mail: info@croydex.co.uk