

QU30025, QU 30831
40158, 53156

Crabtree STARBREAKER

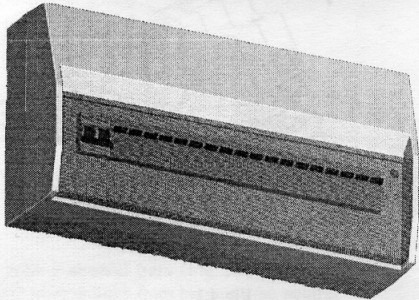

Installation Instructions Consumer Units

Product	Main switch Controlled	RCCB Protected	Split-Load	Multi-Tariff	Dual Tariff Split-Load	Dual RCCB	Max cable Capacity
Enclosure	✓	✓	✓	✓	✓	✓	
Busbar	✓	✓	✓	✓	✓	✓	
100A DP Main Switch (100/M12)	✓	✗	✓	✓	✓	✗	50mm ²
100A DP Main Switch with tap off (100/2MT)	✗	✗	✗	✗	✗	✓	50mm ²
Main incoming RCCB	✗	✓	✗	✗	✗	✓	50mm ²
Split-load RCCB	✗	✗	✓	✗	✓	✓	50mm ²
MCBs	✓	✓	✓	✓	✓	✓	16mm ²
RCBOs	✓	✗	✓	✓	✓	✓	10mm ²

1. Important Information

- This unit should be installed by a qualified competent person in accordance with all relevant legislation and regulations including building regulations and wiring regulations BS7671. In fit doubt contact a qualified competent person.
- The total current supplied by the unit must not exceed the rating of the incoming main switch or RCCB or any additional limitation (as shown on the way label).
- The total sum of the individual MCB ratings may exceed this value where there is appropriate diversity on the installation.
- This product is suitable for indoor use only and is rated at IP2XC.
- The consumer unit and associated components have been type tested to the following specifications:
Consumer Unit – BSEN60439-3
MCBs – BSEN 60898 – Type B or C
RCCBs – BSEN 61008-1
RCBOs – BSEN 61009-1
Main Switch - BSEN 60947-3

Ambient Temperature Considerations

The Starbreaker MCBs are calibrated to meet the 30°C Ref Calibration Temperature requirements of BSEN 60898.

At other temperatures the following rating factors should be used:

At 60° 0.9 At 20° 1.0 At 0° 1.1

Adjacent thermal-magnetic MCBs should not be continuously loaded or approaching their nominal rated currents when mounted in enclosures. It is good engineering practice to apply generous derating factors or make provision for adequate free air between devices. In these situations, and in common with other manufacturers, we recommend a 60% diversity factor is applied to the MCB nominal rated current where it is intended to load the MCBs continuously (in excess of 1 hour)

Before fitting the front cover, check the tightness of all screw type connections, including factory made connections.

2. Enclosure Mounting

- The mounting rail assembly can be removed if required by undoing the fixings at either end of the rail (Fig 2.1)

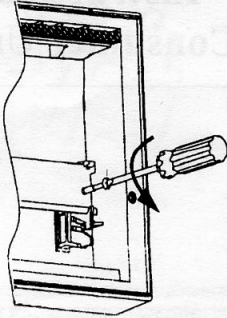

Fig 2.1

- Remove appropriate cut-outs using a sharp knife, or remove appropriate knockouts on metal cased units.
- Fix base to wall using screws and rawplugs as appropriate
- Bring cables through appropriate apertures.
- Route main incoming cables to desired position.
- Replace interior if previously removed.

3. Busbar Installation

- Fit the busbar into the supports and push fully home. (Fig 3.1)

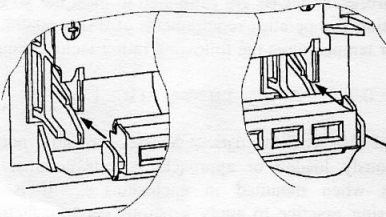

Fig 3.1

Note: Split - load and multi-tariff busbars have a red insert between the sections of the busbar, this gives a clear indication of the modular split
2 connectors are supplied with all split-load busbars for RCCB connection. (See Fig 5.2)

4. Connection of Main Incoming Device

- Clip main incoming device onto the mounting rail in the desired position and push fully home. Ensure the retaining clip engages (Fig 4.1)

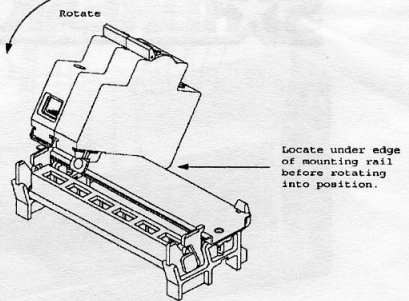

Fig 4.1

Cut and dress the main incoming cables and earth conductor. Fit them into the appropriate terminals

Note: The holes at the extreme end of the earth bar are for bonding purposes.

- Tighten the main incoming terminals securely. The recommended torque figure is 2.3Nm (20lbf-in)
- Connect the pre-formed neutral connector to the main switch and the left-hand neutral bar. (Fig 4.2)

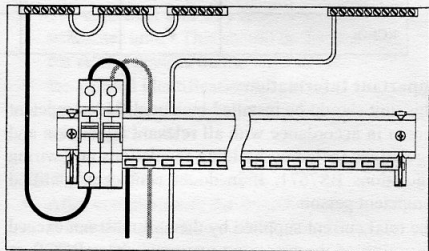

Fig 4.2

Note: The neutral connector fitted to all enclosures facilitates siting the main incoming device on the left-hand side. If siting is required on the right, this connector should be replaced with a flexible lead of suitable length (16mm²). In split-load applications, the RCCB neutral connections must also be reversed.

5. Split-load RCCB Installation

(If a split-load unit is not required go to section 6)

- Clip the desired RCCB onto the mounting rail and push fully home. (Fig 5.1)

Important: When fitting the RCCB ensure the two connecting pins straddle the red blanking tag in the busbar assembly.

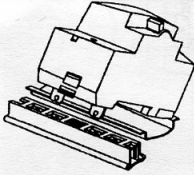

Fig 5.1

- Units with 2 neutral bars (Fig 5.2)** Remove the solid neutral links from between the neutral bars.

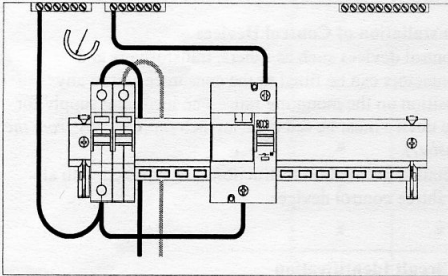

Fig 5.2

- Units with 3 neutral bars. (Fig 5.3)** Remove one of the solid neutral links (according to the required split of the unit) from between the neutral bars.

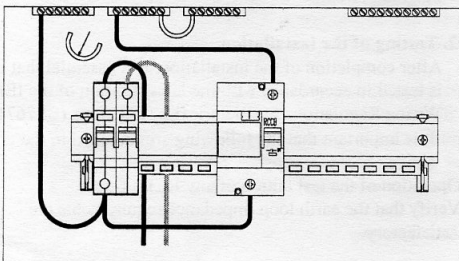

Fig 5.3

- Connect the neutral cables supplied with the split-load busbar to the appropriate terminals as shown. (Fig 5.2 or 5.3)

6. Other Configurations

- The following diagrams illustrate the methods of installation for various other configurations.

Multi Tariff

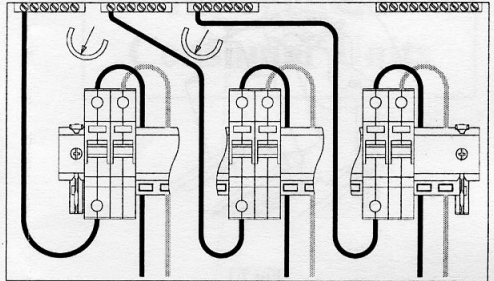

Fig 6.1

Dual Tariff Split-load

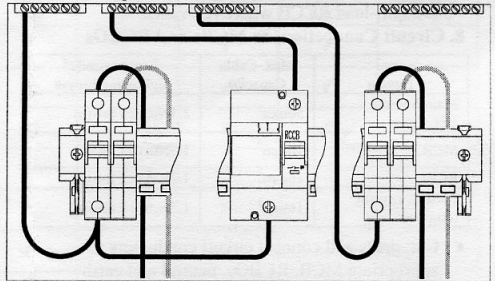

Fig 6.2

Dual RCCB

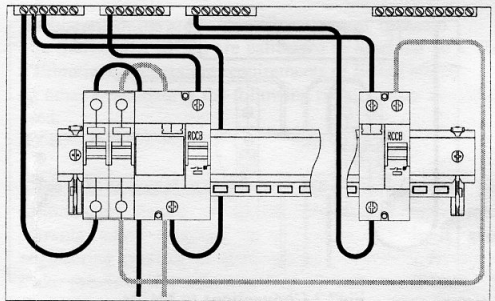

Fig 6.3

Note: Main switch with tap off (100/2MT) required.

7. Installation of MCBs and RCBOs

- MCBs and RCBOs are mounted in the same manner as main incoming devices (Fig. 7.1). Ensure the retaining clip engages.

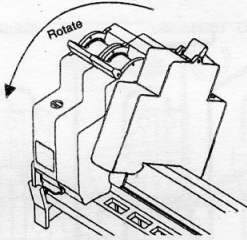

Fig 7.1

- It is recommended that the highest rated MCB or RCBO is fitted nearest to the main incoming device (or split-load RCCB where relevant).

8. Circuit Connections to MCBs and RCBOs

Device	Max. Cable Capacity	Recommended tightening torque
Main Switch / RCCB	50mm ²	2.3Nm (20 lbf-in)
MCB	16mm ²	1.7Nm (15 lbf-in)
RCBO	16mm ²	1.7Nm (15 lbf-in)
Earth & neutral terminals	16mm ²	1.7Nm (15 lbf-in)

- Cut, dress and connect circuit conductors to appropriate MCB, RCBOs, neutral and earth terminals. (Figs 7.2 and 7.3)
- Ensure that each earth and neutral outgoing circuit is correctly made to its corresponding numbered terminal (Figs 7.2 and 7.3)

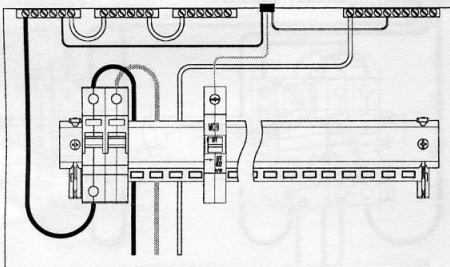

Fig.7.2 Connections to MCBs

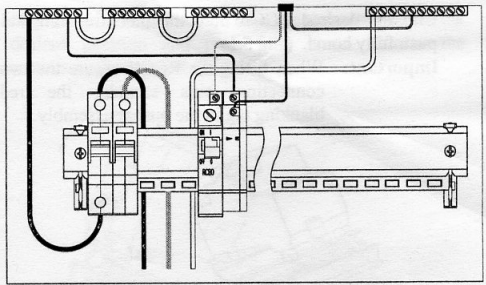

Fig 7.3 Connections to RCBOs

9. Blanking of unused ways

- Blanking plates should be fitted to cover any spare modular ways. Blanking plates are available if required

10. Installation of Control Devices

- Control devices such as timers, transformers and contactors can be fitted to the consumer unit in any position on the mounting rail. The incoming supply for the device must be fed from an mcb (*not directly from the busbar*).
- Detailed installation instructions are supplied with all Crabtree control devices.

11. Circuit Identification

- The consumer unit way label is supplied with the consumer unit. This should be fixed into position below the circuit devices on the front cover.
- Pre-printed identification labels are provided and should be fixed in position on the way label according to the outgoing circuit.

12. Testing of the installation

- After completion of the installation, it is essential that it is tested in accordance with the latest Edition of the IEE Wiring Regulations for Electrical Installations (BS7671).
- It is important that the following are included in the above.
 - Operation of the test button of any RCDs fitted.
 - Verify that the earth loop impedance requirements are satisfactory.

Crabtree

Electrium Sales Limited, Walkmill Lane, Cannock, WS11 0XE, England

Tel: 01543 455000

Fax: 01543 455001