

FITTING THE PROGRAMMER

If surface wiring has been used, remove the knockout/insert from the bottom of the programmer to accommodate it. Loosen the two 'captive' retaining screws on the bottom of the Backplate. Now fit the programmer to the Backplate, ensure the lugs on the Backplate engage with the slots on the programmer. Swing the bottom of the programmer into position ensuring that the connection pins on the back of the unit locate into the terminal slots in the backplate. Tighten the two 'captive' retaining screws to fix the unit securely. **Then switch on the mains supply.**

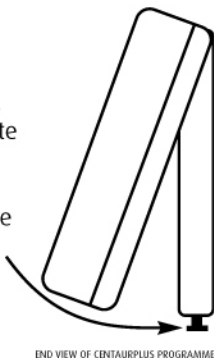

END VIEW OF CENTAURPLUS PROGRAMMER

UPON COMPLETION OF INSTALLATION PLEASE RESET THE PROGRAMMER, BEFORE SETTING THE HEATING AND HOT WATER OPERATIONS.

RESETTING THE PROGRAMMER
On the CentaurPlus press SET and CH buttons together. Then release the buttons and the programmer will return to preset factory settings. The Preset factory settings are illustrated on page 2 of the USER GUIDE.



The unit can now be programmed to suit the User's requirements. Please refer to the User's Guide provided.

GENERAL INFORMATION

Before handing over the installation to the user, always ensure that the system responds correctly on all control programmes and that other electrically operated equipment and controls are correctly adjusted. **EXPLAIN HOW TO OPERATE THE CONTROLS AND HAND OVER THE USERS OPERATING INSTRUCTIONS TO THE USER.**

SPECIFICATION C21 - C27

Contact type: Micro dis-connection
Contact rating: 3(1)Amps 230-240V AC
Power supply: 230-240V AC 50Hz
Operating Temperature range: 0°C to 40°C
Double insulated.
Dirt protection: Normal situations.
Enclosure protection: IP30
Purpose of control: Electronic time switch
Independently mounted control for surface mounting.
Operating time limitation: Continuous
Type 1 Action
Battery Reserve: 10 months continuous operation(minimum)
Case material: Thermoplastic, flame retardant

Dimensions: 150mm x 84mm x 29mm
Display: Liquid crystal
Clock: 12 hour AM/PM
Display time adjustment: 1Minute steps
Switched time adjustment: 10 Minute steps
Programme selection: Auto, On all day, On constant, Off, Holiday
Operating periods per day: Three for HW, Three for CH - (Separate daily programmes for C27)
Override: 1 Hour Boost on Hot water Instant advance on Central Heating
Backplate: Industry Standard Backplate

Horstmann Controls Limited

Bristol

BS4 1UP

t:0117 9788 773 - f:0117 9788 701



LEAFLET No P60499
ISSUE 5

**CENTAURPLUS C21 - C27
INSTALLATION INSTRUCTIONS**

Horstmann's CentaurPlus - Two Channel Programmers Offer up to three programmed operating periods per day with Hot water Boost and Heating Advance control on a fully pumped system.

INSTALLATION AND CONNECTION SHOULD ONLY BE CARRIED OUT BY A SUITABLY QUALIFIED PERSON AND IN ACCORDANCE WITH THE CURRENT EDITION OF THE IEE WIRING REGULATIONS.

WARNING : ISOLATE MAINS SUPPLY BEFORE COMMENCING INSTALLATION

FITTING THE BACKPLATE

Once the Backplate has been removed from the packaging please ensure the programmer is re-sealed to prevent damage from dust, debris etc. The Backplate should be fitted with the wiring terminals located at the top and in a position which allows a total clearance of at least 50mm around the programmer.

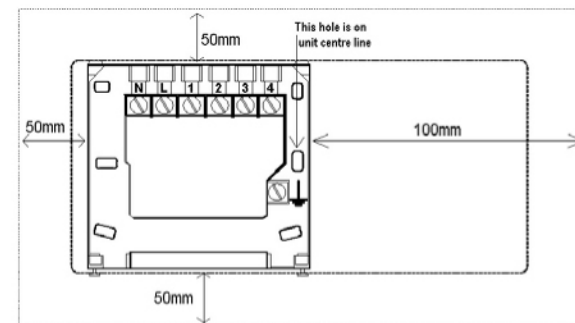

DIRECT WALL MOUNTING

Offer the plate to the wall in the position where the programmer is to be mounted, remembering that the Backplate fits to the left hand end of the programmer. Mark the fixing positions through the slots in the Backplate(Fixing centres 60.3mm), drill and plug the wall, then secure the plate in position. The slots in the Backplate will compensate for any misalignment of the fixings.

WIRING BOX MOUNTING

The Backplate may be fitted directly on to a single gang steel flush wiring box complying with BS4662, using two M3.5 screws. CentaurPlus programmers are suitable for mounting on a flat surface only, they must not be positioned on a surface mounted wall box or on unearthed metal surfaces.

ELECTRICAL CONNECTIONS

All necessary electrical connections should now be made. Flush wiring can enter from the rear through the aperture in the Backplate. Surface wiring can only enter from beneath the programmer and must be securely clamped.

The mains supply terminals are intended to be connected to the supply by means of fixed wiring. The recommended cable sizes are 1.0mm² or 1.5mm².

NEW INSTALLATIONS

Example circuit diagrams for some typical installations are shown below. These diagrams are schematic and should be used as a guide only.

Please ensure that all installations comply with the current IEE regulations.

For reasons of space and clarity not every system has been included and the diagrams have been simplified, for instance some Earth connections have been omitted.

Other control components shown in the diagrams i.e. Valves, RoomStats etc are general representations only. However the wiring detail can be applied to the corresponding models of most manufactures e.g. Horstmann, Honeywell, Danfoss Randall, ACL Drayton etc.

Cylinder and Room Thermostat Key:

C = Common CALL = Call for heat or break on rise SAT = Satisfied on rise N = Neutral

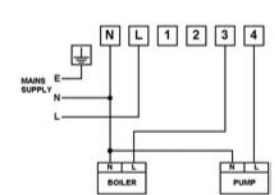

1. Gravity Hot water with Pumped Heating

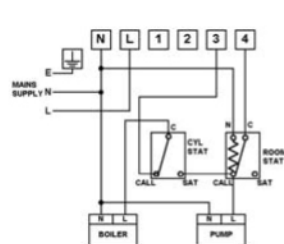

2. Gravity Hot water with Pumped Heating via RoomStat and CylinderStat

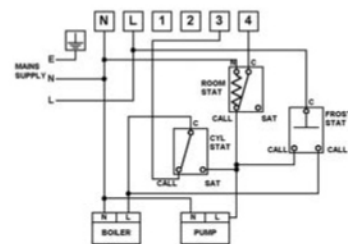

3. Gravity Hot water with Pumped Heating via RoomStat and CylinderStat including Frost protection via double pole FrostStat

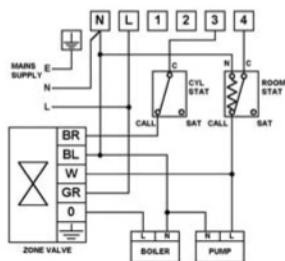

4. Gravity Hot water with Pumped Heating via RoomStat, CylinderStat and Two Port Zone Valve (with Changeover Auxiliary Switch) on Hot Water circuit

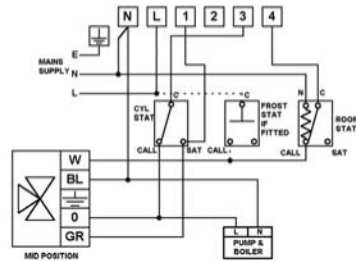

5. Fully Pumped Heating System using RoomStat, CylinderStat and Three Port Mid-Position Valve

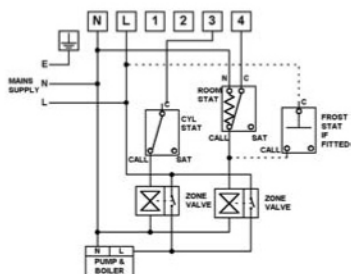

6. Fully Pumped System using RoomStat and Two (2 Port) Spring Return Zone Valve with Auxiliary Switches

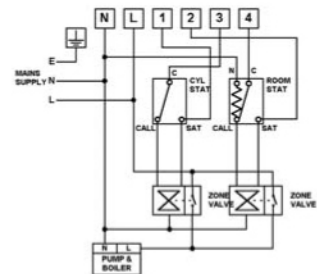

7. Fully Pumped System using RoomStat and CylinderStat and Two (2 Port) Motorised Valve with Auxiliary Switches

ELECTRICAL CONNECTIONS

CentaurPlus programmers are double insulated and do not require an Earth connection but an Earth connection block is provided on the Backplate for terminating any cable Earth conductors. Earth continuity must be maintained and all bare Earth conductors must be sleeved. Ensure that no conductors are left protruding outside the central space enclosed by the Backplate.

INTERNAL WIRING DIAGRAM C21 - C27

Your CentaurPlus has an integral connection which makes it only suitable for mains voltage applications. No additional linking is required between terminals.

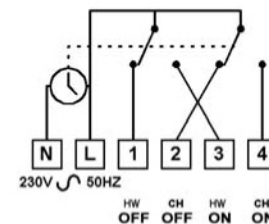

COMMISSIONING THE PROGRAMMER

Ensure all dust and debris has been cleared away from the work area before removing the programmer from its packaging.

All CentaurPlus programmers are suitable for GRAVITY HOT WATER or FULLY PUMPED systems.

On a FULLY PUMPED or CONTROLLED systems it is possible to programme independent time settings for Hot water and Heating.

On GRAVITY or PARTIALLY CONTROLLED systems the Hot water and Heating follow a common time setting. It is not usually possible to have Heating without Hot water.

Correct control of each type of system is ensured by a BLUE CIRCUIT LINK located on the rear of the programmer.

If the programmer is to control a GRAVITY HOT WATER system this link should be removed by simply pulling it out of the back of the programmer. When used to control a FULLY PUMPED system the link must remain in situ.

REAR VIEW OF CENTAURPLUS PROGRAMMER

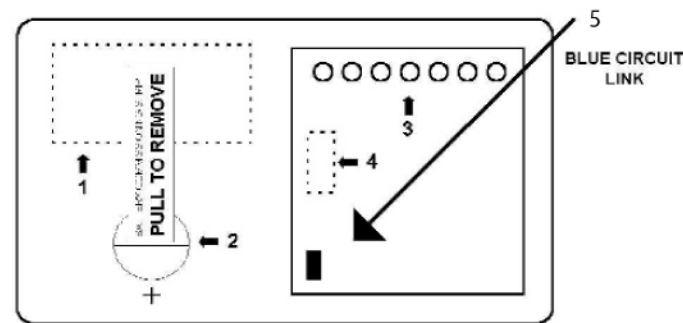

- 1 - RATINGS LABEL
- 2 - BATTERY
- 3 - CONNECTOR PINS
- 4 - PRODUCTION DATE LABEL
- 5 - BLUE CIRCUIT LINK

BATTERY RESERVE

The Battery must be commissioned prior to fitting the control to the Backplate.

This is achieved by the means of a COMMISSIONING STRIP situated on the back of the unit. Pull out the battery commissioning strip at the back of the programmer and re-insert the Battery, the reserve is now activated. When the programmer is running on battery reserve the clock display will disappear. This is to prolong the life of the battery.

BATTERY

The programmer is fitted with a non-rechargeable, long life battery, which will maintain the programmed time settings for a minimum of ten months with the supply disconnected. THIS SHOULD BE SUFFICIENT TO COVER POWER INTERRUPTIONS DURING THE LIFE OF THE UNIT. During power interruptions the display will be blank, after 3 days the current time of day will be lost. These measures are to prolong the battery life.

SERVICE AND REPAIR

This programmer is NOT user serviceable. Please do not dismantle the unit. In the unlikely event of a fault developing please refer to the RESETING THE PROGRAMMER section of this user guide located on page 2. If this fails to resolve the problem please contact a local heating engineer or a qualified electrician.

QUESTIONS AND ANSWERS

The unit display has become frozen	This could be due to local electrical interference Using the RESET procedure may rectify the fault.
The indicator neon fails to illuminate on Hot water or Central heating channel	Using the RESET procedure may rectify the fault. If the problem persists the programmer will need replacing.
The indicator neon will illuminate but the pump and/or boiler fails to operate	This may indicate a problem elsewhere in your system; E.g. A zone valve, etc. please contact a registered installer for advice.
There is no display on the programmer	Try the RESET procedure on page 2, if this fails to rectify the problem please have the mains supply checked
How do I know if the programmer is still under warranty	The CentaurPlus range comes with a 2 year guarantee from the date of manufacture. This date is located on the rear of the unit, indicated by a month over a year
How is the programmer removed from the wall	WARNING: The CentaurPlus programmer must only be removed from it's backplate by either a qualified electrician or heating engineer; The programmer plugs in to a 6 pin backplate located on the rear of the unit and is secured using 2 screws located on the bottom surface of the unit. Undo these screws and pull forward and up in an arc motion

Horstmann Controls Limited
Bristol
BS4 1UP



LEAFLET No P60498
ISSUE 4

CENTAURPLUS C27
USER INSTRUCTIONS



HORSTMANN

Horstmann's C27 - Two Channel Programmer Offers up to three programmed operating periods per day, seven days a week, with Hot water Boost and Heating Advance control on a fully pumped system.

The following are some of the easy to operate features:-

Flexible 7 Day Control
1 Hour Boost on Hot Water
Independent timing on Hot Water and Heating
Central Heating Advance gives instant On/Off override
Up to 3 On/Off periods per channel in each 24Hr operation.
Programme options: Auto / All day / 24 Hours / Off

FRONT VIEW OF PROGRAMMER

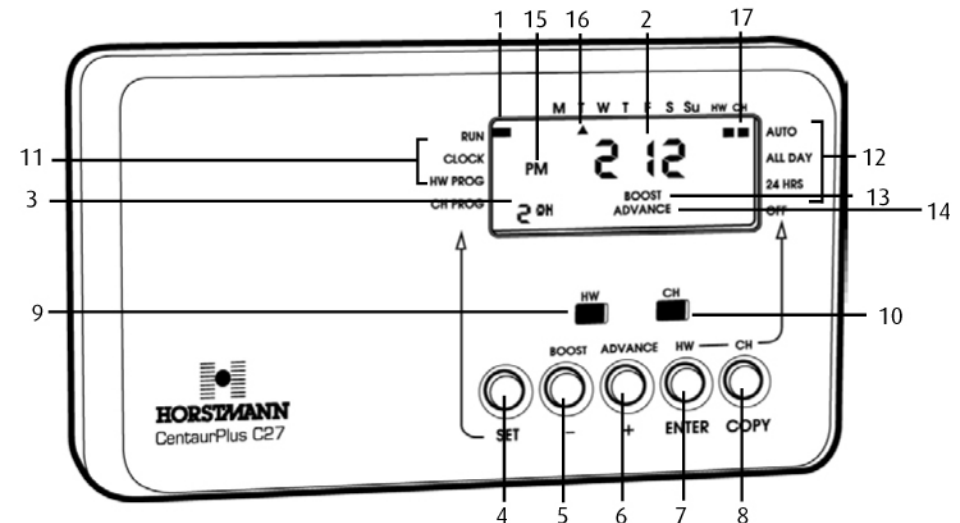

- | | |
|--|---------------------------------|
| 1.SET indicator | 10.Central heating ON indicator |
| 2.Time of day | 11.SET positions |
| 3.Switch Period symbol | 12.PROGRAMME positions |
| 4.SET Button | 13.BOOST symbol |
| 5.Hot water BOOST or adjust (-) button | 14.ADVANCE symbol |
| 6.Central heating ADVANCE or adjust (+) button | 15.AM/PM symbol |
| 7.Hot water (HW) select or ENTER Button | 16.Day of week indicator |
| 8.Central heating (CH) select or COPY button | 17.PROGRAMME indicators |
| 9.Hot water ON indicator | |

RESETTING THE PROGRAMMER

Electronic equipment can in some circumstances be affected by electrical interference. If the programmer's display becomes frozen or scrambled; or if you wish to revert back to the default time settings please use the following procedure.

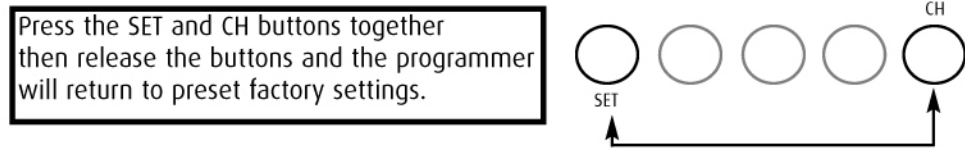

The simple instructions below are designed to help with the programming of the unit.

SETTING DAY AND TIME OF DAY

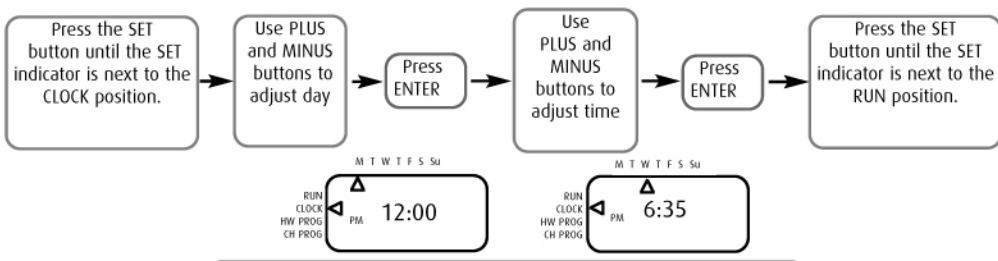

DEFAULT TIME SETTINGS

The default factory settings are shown, however if you wish to change these proceed as instructed below.

	1st ON	1st OFF	2nd ON	2nd OFF	3rd ON	3rd OFF
MON-FRI	6:30 AM	8:30 AM	12:00 PM	12:00 PM	4:30 PM	10:30 PM
SAT/SUN	7:30 AM	10:30 AM	12:00 PM	12:00 PM	5:00 PM	11:00 PM

SETTING THE ON AND OFF TIMES

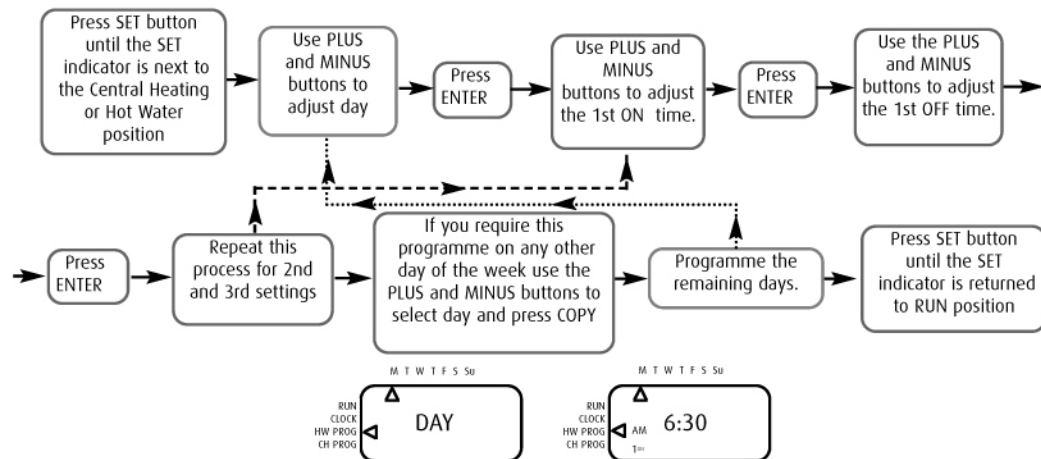

Should you encounter any problems, please refer to the Question and Answer section located on page 4.

INFORMATION AND ADVICE

Programming ON/OFF times

If a Heating or Hot water period is not required it can be cancelled by setting the ON and OFF settings to the same time. Example ON 10:00am OFF 10:00am

FULLY PUMPED OR GRAVITY SYSTEM

The installer will have set the programmer to suit the installed system. If this is a Fully pumped system this will allow independent control of the Central heating and Hot water, however on a Gravity system the Central heating and Hot water are linked so that it is not possible to use the Central heating independently.

This will allow only one common time setting for both Hot Water and Central Heating.

SPECIAL FEATURES

The SET indicator must remain in the RUN position for the following instructions. The following actions work independently on either Hot Water or Central Heating.

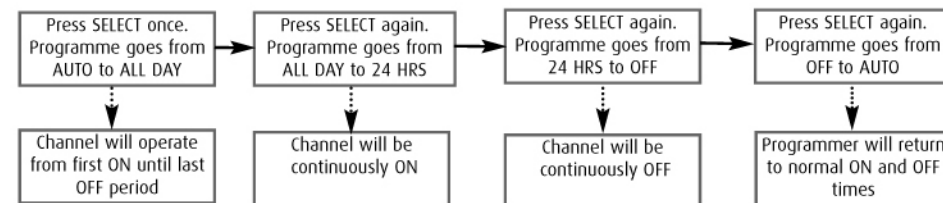

BOOST FUNCTION - 1-hour temporary override

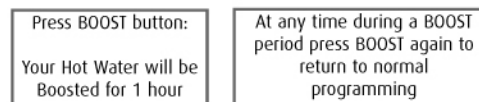

ADVANCE FUNCTION - Brings forward next ON or OFF operation

